

CHAPTER 8830
DEPARTMENT OF TRANSPORTATION
RAILROADS

DEFINITIONS, STANDARDS, APPLICABILITY		CLEARANCES	
8830.0100	DEFINITIONS; INCORPORATIONS BY REFERENCE.	8830.3000	STRUCTURE AND TRACK CLEARANCES; VARIANCES.
8830.0200	APPLICATION.	ACCIDENT REPORTS; TRACK SAFETY STANDARDS	
8830.0220	NO RETROACTIVE EFFECT; EXCEPTION.	8830.3100	RAIL CARRIER ACCIDENT REPORT.
RAILROAD-HIGHWAY GRADE CROSSINGS		8830.3150	GRADE CROSSING SYSTEM FAILURE, REPORT.
8830.0300	CROSSING INVENTORY NUMBER.	8830.3200	TRACK SAFETY STANDARDS.
8830.0310	PRIVATE CROSSING STANDARDS.	ACCOUNTING	
8830.0320	VISIBILITY STANDARDS.	8830.3300	BILLING.
SIGNS, SIGNALS, OTHER SAFETY MEASURES		8830.3400	ACCOUNTING CLASSIFICATIONS; REPORTS.
8830.0400	SIGNS.	RAIL SERVICE IMPROVEMENT	
8830.0500	CROSSBUCK SIGN.	8830.5300	RAIL REHABILITATION PROJECT.
8830.0600	ADVANCE-WARNING SIGNS.	8830.5450	FINANCIAL ASSISTANCE FOR REGIONAL AUTHORITY.
8830.0700	SUPPLEMENTARY ADVANCE-WARNING SIGNS.	8830.5500	CAPITAL IMPROVEMENT PROJECT.
8830.0750	OTHER REGULATORY SIGNS.	8830.5600	INFORMATION REQUIREMENTS.
8830.0800	STOP SIGNS.	8830.5650	CONTRACTS.
8830.0900	PAVEMENT MARKINGS.	8830.5690	REQUEST FOR INFORMATION.
8830.1000	ACTIVE WARNING DEVICES; STANDARDS, USE, ALTERATION, REMOVAL.	8830.5700	DISCLOSURE OF RAIL CARRIER DATA.
8830.1200	OPERATION OF ACTIVE WARNING DEVICE; CONTROLS.	RAIL BANK	
8830.1400	FLASHING LIGHT UNITS.	8830.5810	PROGRAM CRITERIA.
8830.1500	BELLS.	8830.5820	ACQUIRING RAIL BANK PROPERTY.
8830.1525	AUTOMATIC GATES.	8830.5830	UTILIZING RAIL BANK PROPERTY.
8830.1550	GATE OPERATION AND CONTROL.	8830.5840	DISPOSING OF RAIL BANK PROPERTY.
8830.1600	PLACEMENT OF ACTIVE WARNING DEVICE.	8830.5850	MANAGEMENT OF RAIL BANK PROPERTY.
8830.1650	TRAFFIC SIGNAL NEAR GRADE CROSSING.	8830.5860	ADMINISTERING STATE RAIL BANK PROGRAM; VARIANCES.
8830.1700	GUARD RAIL.	RAIL USER AND RAIL CARRIER LOAN GUARANTEE	
8830.2125	PLAN APPROVAL FOR ACTIVE WARNING DEVICE.	8830.6300	APPLICATION FOR BANK LOAN.
8830.2150	OPERATING LICENSE.	8830.6400	APPLICATION FOR LOAN GIVEN BY PUBLIC AUTHORITY.
8830.2425	MAINTAINING, OPERATING ACTIVE WARNING DEVICES.	8830.6500	ELIGIBILITY REQUIREMENTS FOR BANK LOAN.
8830.2500	FLAGGER.	8830.6600	ELIGIBILITY REQUIREMENTS FOR PUBLIC AUTHORITY LOAN.
GRADE CROSSINGS		8830.6700	INTEREST ADJUSTMENT.
8830.2650	MAINTAINING GRADE CROSSING SURFACE.	EXHIBITS, FIGURES, TABLES	
8830.2700	ESTABLISHING, RELOCATING, CHANGING GRADE CROSSING.	8830.9901	SIGNS, ACTIVE WARNING DEVICES, AND LOCATIONS.
8830.2710	ESTABLISHING, RELOCATING GRADE CROSSING; CRITERIA.	8830.9911	CROSSBUCK AND AUXILIARY SIGN.
8830.2720	VACATING GRADE CROSSING.	8830.9921	ADVANCE-WARNING SIGNS.
8830.2730	CONSOLIDATING GRADE CROSSING.	8830.9931	SUPPLEMENTARY ADVANCE-WARNING SIGNS.
8830.2740	GRADE SEPARATION AT CROSSING.	8830.9941	OTHER REGULATORY SIGNS.
8830.2750	ABANDONED CROSSING.	8830.9951	CLEARANCES.
8830.2760	TRAIL AND BICYCLE PATH GRADE CROSSING.	8830.9961	STANDARD "NO CLEARANCE" SIGN.
		8830.9971	WARNING SIGN FOR TRAIN CREW MEMBERS.
		8830.9991	OPERATING LICENSE.

DEFINITIONS, STANDARDS, APPLICABILITY

8830.0100 DEFINITIONS; INCORPORATIONS BY REFERENCE.

Subpart 1. [Repealed, 23 SR 524]

Subp. 1a. **Scope.** The terms used in parts 8830.0100 to 8830.9971 have the meanings given them in this part.

Subp. 2. [Repealed, 23 SR 524]

Subp. 3. [Repealed, 23 SR 524]

Subp. 4. [Renumbered subp. 26]

Subp. 5. [Renumbered subp. 27]

Subp. 6. [Repealed, 23 SR 524]

Subp. 7. [Repealed, 23 SR 524]

Subp. 8. [Renumbered subp. 67]

Subp. 9. [Renumbered subp. 16a]

Subp. 10. **AASHTO.** "AASHTO" means the American Association of State Highway and Transportation Officials.

Subp. 11. **AASHTO design manual; incorporation.** "AASHTO design manual" refers to "A Policy on Geometric Design of Highways and Streets," 1990 edition, published by AASHTO, 444 North Capitol Street N.W., Suite 225, Washington, D.C. 20001. This publication and future revisions of this publication are incorporated by reference. This publication is not subject to frequent change and is available to the public through the Minitex interlibrary loan system.

Subp. 12. **Abandoned.** "Abandoned" has the meaning given it in Minnesota Statutes, section 222.63, subdivision 1, paragraph (a).

Subp. 13. **Acquire.** "Acquire" means to purchase a rail line with state funds provided for the state rail bank program.

Subp. 14. **Active warning device.** "Active warning device" means a device with alternating flashing red lights. The device may have additional features, including but not limited to a bell, cantilever arm, or movable gate arm.

Subp. 15. **ADT.** "ADT" means average daily traffic.

Subp. 16. **AREMA manual; incorporation.** "AREMA manual" means the "Manual for Railway Engineering," which is updated annually and published by the American Railway Engineering and Maintenance of Way Association, 8201 Corporate Drive, Suite 1125, Landover, MD 20785. This manual and future revisions of this manual are incorporated by reference. This manual is available to the public through the Minitex interlibrary loan system.

Subp. 16a. **AREMA signal manual; incorporation.** "AREMA signal manual" means the American Railway Engineering and Maintenance of Way Association, "Signal Manual of Recommended Practices," 1990 edition, published by the American Railway Engineering and Maintenance of Way Association, 8201 Corporate Drive, Suite 1125, Landover, MD 20785. This manual and future revisions of this manual are incorporated by reference. This manual is not subject to frequent change and is available to the public through the Minitex interlibrary loan system.

Subp. 17. **Borrower.** "Borrower" means any "rail user" as that term is defined in Minnesota Statutes 1978, section 222.56 subdivision 7.

Subp. 18. **Capital improvement.** "Capital improvement" means the implementation of projects designed to improve rail service or reduce the economic impact of discontinuing rail service described in Minnesota Statutes, section 222.58, subdivision 2, paragraph (b), clause (2).

Subp. 19. **Collateral.** "Collateral" means the security pledged for the loan, which shall include land, buildings, machinery, equipment, furniture, fixtures, accounts receivable, marketable securities, cash surrender value of life insurance, assignment of leases or leasehold interests, and similar kinds of property and property interests.

Subp. 20. **Commissioner.** "Commissioner" means the commissioner of the Minnesota Department of Transportation.

Subp. 21. **Demonstration project.** "Demonstration project" means an experimental project to improve rail service that has general application within the state but is not traditionally associated with rail transportation.

Subp. 22. **Dispose.** "Dispose" means to convey property to a governmental subdivision of the state for any of the purposes in Minnesota Statutes, section 222.63, subdivision 4, or to sell the property as provided in Minnesota Statutes, section 222.63, subdivision 5.

Subp. 23. **Fair market value.** "Fair market value" means the value of property, materials, or labor as determined by the presently accepted value of like property, materials, or labor within the rail industry.

Subp. 24. **Farm crossing.** "Farm crossing" means a private crossing used for moving motor vehicles, farm machinery, or livestock in connection with agricultural pursuits, forestry, or other land-productive purposes.

Subp. 25. **Federal-Aid Policy Guide; incorporation.** "Federal-Aid Policy Guide" refers to the Federal-Aid Policy Guide or FAPG, 1991 edition, which is updated annually and published by the FHWA, 400 Seventh Street S.W., Washington, D.C. 20590. This publication and future revisions of this publication are incorporated by reference. This publication is not subject to frequent change and is available to the public through the Minitex interlibrary loan system.

Subp. 26. **FHWA.** "FHWA" means the Federal Highway Administration, an agency of the USDOT.

Subp. 27. **FRA.** "FRA" means the Federal Railroad Administration, an agency of the USDOT.

Subp. 28. **Going concern value.** "Going concern value" means the value of the rail line as an operating business entity.

Subp. 29. **Grade crossing.** "Grade crossing" means the at-grade intersection of one or more railroad tracks with a public way.

Subp. 30. **Grade separation.** "Grade separation" means the use of a bridge, trestle, tunnel, culvert, or other structure to enable one or more railroad tracks and a public way to cross at different elevations.

Subp. 31. **Grant.** "Grant" means funds not requiring repayment unless the property purchased or improved with these funds ceases to be used for rail transportation.

Subp. 32. **Guarantee.** "Guarantee" has the meaning given it in Minnesota Statutes, section 222.56, subdivision 3a.

Subp. 33. **Industrial crossing.** "Industrial crossing" means a private crossing used to provide access between industrial plant facilities or to an industrial or other commercial area.

Subp. 34. **In-kind participation.** "In-kind participation" means the fair market value of noncash contributions provided by a party to an agreement, and may include property and charges for labor or materials benefiting and specifically identifiable to a rail rehabilitation project.

Subp. 35. **Lender.** "Lender" shall have the meaning given it in Minnesota Statutes, section 222.56, subdivision 4.

Subp. 36. **Loan.** "Loan" means funds requiring repayment with or without interest under terms and conditions negotiated in a contract among the rail carrier, rail users, and Mn/DOT. However, for the purposes of parts 8830.6300 to 8830.6700, "loan" has the meaning given it in Minnesota Statutes, section 222.56, subdivision 5.

Subp. 37. **Local rail freight assistance program.** "Local rail freight assistance program" means a federal program created under the federal Railroad Revitalization and Regulatory Reform Act of 1976, found at United States Code, title 49, chapter 221, as amended, and implemented pursuant to Code of Federal Regulations, title 49, chapter 18, as amended.

Subp. 38. **MMUTCD; incorporation.** "MMUTCD" means the "Minnesota Manual on Uniform Traffic Control Devices for Streets and Highways," published by the Minnesota Department of Transportation, Office of Traffic Engineering, according to Minnesota Statutes, section 169.06, subdivision 1. This manual and future revisions of this manual are incorporated by reference. This manual is not subject to frequent change and is available to the public through the Minitex interlibrary loan system.

Subp. 39. **Mn/DOT.** "Mn/DOT" means the Minnesota Department of Transportation.

Subp. 40. **Moving vehicle sight triangle.** "Moving vehicle sight triangle" means a triangle that is formed when the three sides of the triangle consist of:

- A. the distance from the crossing along the track to the approaching train;
 - B. the distance from the crossing along the roadway to the approaching vehicle;
- and
- C. the distance between the train and the vehicle.

Subp. 41. **Net liquidation value.** "Net liquidation value" has the meaning given it in Code of Federal Regulations, title 49, section 1152.34, paragraph (c)(1)(iii), as amended.

Subp. 41a. **Other uses.** "Other uses" means any uses of rail bank property other than those specified in Minnesota Statutes, section 222.63, subdivisions 2 and 2b.

Subp. 42. **Preserve.** "Preserve" means to hold rail bank property during the period of time it is not being utilized for the purposes specified in Minnesota Statutes, section 222.63, subdivision 2b.

Subp. 43. **Private crossing.** "Private crossing" means the at-grade intersection of one or more railroad tracks with a private roadway.

Subp. 44. **Private roadway.** "Private roadway" means a roadway owned by a private or governmental entity that is open for use to only the owners and their invitees.

Subp. 45. **Public way.** "Public way" means a route used to go from one place to another that meets the following criteria:

- A. it has been improved for transportation use;
- B. it is under the jurisdiction of, and maintained by, a governmental entity; and
- C. it is open to the traveling public.

Subp. 46. **Rail carrier.** "Rail carrier" has the meaning given it in Minnesota Statutes, section 222.56, subdivision 8, and includes railroad companies operating a railroad.

Subp. 47. **Rail line.** "Rail line" has the meaning given it in Minnesota Statutes, section 222.48, subdivision 4.

Subp. 48. **Rail rehabilitation.** "Rail rehabilitation" means the rebuilding of a rail line or portions thereof and/or the implementation of other allied projects that will improve rail service.

Subp. 49. **Rail service.** "Rail service" has the meaning given it in Minnesota Statutes, section 222.48, subdivision 5.

Subp. 50. **State rail service improvement account.** "State rail service improvement account" means the special revenue account created in the state treasury by the act.

Subp. 51. **Rail service improvement program.** "Rail service improvement program" means the program created in Minnesota Statutes, section 222.50, subdivision 1.

Subp. 52. **Rail user.** "Rail user" has the meaning given it in Minnesota Statutes, section 222.48, subdivision 6.

Subp. 53. **Rail user and rail carrier loan guarantee program.** "Rail user and rail carrier loan guarantee program" means the program established by Minnesota Statutes, section 222.55.

Subp. 54. **Reflectorized.** "Reflectorized" means giving back light to convey the same information by day and night.

8830.0100 RAILROADS

1268

Subp. 55. **Regional Railroad Authority.** "Regional Railroad Authority" means a governmental entity established pursuant to Minnesota Statutes, chapter 398A.

Subp. 56. **Residential crossing.** "Residential crossing" means a private crossing used to provide vehicular access to a private residence or residences for occupants and their invitees.

Subp. 57. **Right-of-way.** "Right-of-way" has the meaning given it in Minnesota Statutes, section 222.63, subdivision 1, paragraph (b).

Subp. 58. **Road authority.** "Road authority" has the meaning given it in Minnesota Statutes, section 160.02, subdivision 25, as well as any other governmental agency having jurisdiction over roadways.

Subp. 59. **Roadway.** "Roadway" means that portion of a highway improved, designed, or ordinarily used for vehicular travel, including the shoulder.

Subp. 60. **Rural area.** "Rural area" means an area outside the boundaries of urban areas.

Subp. 61. **Standard Specification for Structural Supports for Highway Signs, Luminaires and Traffic Signals; incorporation.** "Standard Specification for Structural Supports for Highway Signs, Luminaires and Traffic Signals" is a manual published by AASHTO, 444 North Capitol Street N.W., Suite 225, Washington, D.C. 20001, 1985 edition. This publication and future revisions of this publication are incorporated by reference. This publication is not subject to frequent change and is available to the public through the Minitex interlibrary loan system.

Subp. 62. **State rail bank.** "State rail bank" has the meaning given it in Minnesota Statutes, section 222.63, subdivision 1, paragraph (c).

Subp. 63. **State rail bank program.** "State rail bank program" means the program established pursuant to Minnesota Statutes, section 222.63.

Subp. 64. **Stopped vehicle sight triangle.** "Stopped vehicle sight triangle" means a triangle that is formed when the three sides of the triangle consist of:

- A. the distance from the crossing along the track to the approaching train;
- B. the distance from the crossing along the roadway to a vehicle stopped for the crossing at a location where the stop bar should be, whether the stop bar is in place or not; and
- C. the distance between the train and the vehicle.

Subp. 65. **Surface Transportation Board.** "Surface Transportation Board" is an agency of the United States Department of Transportation.

Subp. 66. **Urban area.** "Urban area" means an area that meets one or more of the following criteria:

- A. it is a city with a population of 5,000 or more;
- B. it is within an urbanized area as defined by the Bureau of the Census, an agency of the United States Department of the Interior;
- C. it contains a business district as defined by Minnesota Statutes, section 169.011, subdivision 13; or
- D. it contains an urban district as defined by Minnesota Statutes, section 169.011, subdivision 90.

Subp. 67. **USDOT.** "USDOT" means the United States Department of Transportation.

Subp. 68. **USDOT-AAR crossing inventory.** "USDOT-AAR crossing inventory" means the national inventory of all grade crossings and private crossings, which is a database maintained, published, and updated by the Office of Safety of the FRA, 400 Seventh Street S.W., Washington, D.C. 20590.

Subp. 69. **Utilize.** "Utilize" means to use banked rail lines for the purposes cited in Minnesota Statutes, section 222.63, subdivision 2b.

Statutory Authority: *MS s 218.041; 218.071; 219.073; 219.165; 219.17; 219.384; 222.50; 222.58; 222.61; 222.63*

History: *23 SR 524*

8830.0200 APPLICATION.

Subpart 1. **Crossings.** Part 8830.0300 is intended to apply to grade crossings, private crossings, and grade separations.

Subp. 2. **Private crossing standards.** Part 8830.0310 is intended to apply safety standards to private crossings in the state.

Subp. 3. **Visibility standards.** Part 8830.0320 is intended to apply visibility standards for all grade crossings and private crossings in the state.

Subp. 4. **Engineering functions.** Parts 8830.0400 to 8830.3400 are intended to apply to railroad-related engineering functions under the jurisdiction of Mn/DOT and apply only to grade crossings and grade separations, not private crossings.

Subp. 5. **Rail rehabilitation.** Parts 8830.5300 to 8830.5700 apply to rail rehabilitation projects implemented under the rail service improvement program.

Subp. 6. **Rail bank property.** Parts 8830.5810 to 8830.5860 apply to acquisition, preservation, utilization, and disposition of rail bank property under the state rail bank program.

Subp. 7. **Rail loans.** Parts 8830.6300 to 8830.6700 apply to loans guaranteed under the rail user and rail carrier loan guarantee program.

Statutory Authority: *MS s 218.041; 218.071; 219.073; 219.165; 219.17; 219.384; 222.50; 222.58; 222.63*

History: *23 SR 524*

8830.0220 NO RETROACTIVE EFFECT; EXCEPTION.

Subpart 1. **Not retroactive.** Parts 8830.0300 to 8830.3400 are not retroactive but are intended to apply to replacements and installations erected on and after September 8, 1998, and to existing installations that are substantially changed, modified, or reconstructed. Installations already lawfully in place before September 8, 1998, are not to be considered in violation of parts 8830.0300 to 8830.3400.

Subp. 2. **Changes required by commissioner.** Notwithstanding subpart 1, the commissioner may require changes or improvements at specific locations so as to conform to the requirements of parts 8830.0300 to 8830.3400 as the commissioner considers necessary to protect the safety of the public at grade crossings and private crossings.

Statutory Authority: *MS s 218.071; 219.073; 219.165; 219.17; 219.384; 222.50; 222.58; 222.63*

History: *23 SR 524*

RAILROAD-HIGHWAY GRADE CROSSINGS

8830.0300 CROSSING INVENTORY NUMBER.

Grade crossings, grade separations, and private crossings have been identified, and the characteristics of each crossing have been tabulated in the USDOT-AAR Crossing Inventory. References to crossings must include crossing inventory numbers when possible. Information regarding the crossing inventory number can be obtained from the Office of Freight, Railroads, and Waterways, Mn/DOT, Mail Stop 470, 395 John Ireland Boulevard, Saint Paul, Minnesota 55155.

When a new crossing is constructed, the rail carrier shall assign a crossing inventory number to the crossing before the crossing may be opened to traffic. The rail carrier shall

8830.0300 RAILROADS

1270

complete the USDOT-AAR crossing inventory form for each new crossing or transmit the required information in any other format approved by the FRA.

Maintenance and replacement of the crossing inventory numbers are the responsibilities of the rail carrier.

A rail carrier or road authority making a change at a crossing shall note the change on the USDOT-AAR crossing inventory form at the time the change is made or shall transmit the required information in any other format approved by the FRA. Copies of the crossing inventory form are available from the Office of Freight, Railroads, and Waterways, Mn/DOT, Mail Stop 470, 395 John Ireland Boulevard, Saint Paul, Minnesota 55155.

Statutory Authority: *MS s 218.071; 219.073; 219.165; 219.17; 219.384; 222.50; 222.58; 222.63*

History: *23 SR 524*

8830.0310 PRIVATE CROSSING STANDARDS.

Subpart 1. **Exclusions.** Private crossings are excluded from the provisions of this part if they are accessible by the public only with the permission of the property owner. Farm crossings that provide access from one farm field to another are excluded.

Subp. 2. **Crossing width.** The width of all private crossings must be the same or greater than the widest of the two approaches to the crossing.

Subp. 3. **Approach grades and crossing surfaces.** Roadway approach grades to a private crossing and crossing surfaces must be in accordance with the AREA manual.

Subp. 4. **Warning signs and devices.** Private crossings consisting of residential crossings, industrial crossings, and farm crossings providing access to a farm field from a public roadway must be signed on each side of the crossing with a 24-inch (600 millimeter) or larger R1-1 stop sign and a rectangular sign, at least 300 square inches (200,000 square millimeters) in size, with the legend "Private Crossing" and the crossbuck symbol installed below the stop sign. If required by part 8830.0320, active warning devices must also be installed at private crossings.

Subp. 5. **Maintenance of signs.** The rail carrier shall install, maintain, and replace signs and active warning devices, with all costs being determined by agreement between the rail carrier and private property owner.

Statutory Authority: *MS s 218.071; 219.073; 219.165; 219.17; 219.384; 222.50; 222.58; 222.63*

History: *23 SR 524*

8830.0320 VISIBILITY STANDARDS.

Subpart 1. **Design standards.** The AASHTO design manual must be used to determine the necessary sight triangle for both a moving vehicle and a vehicle stopped at the crossing. A sight triangle must be cleared so that adequate visibility can be obtained. Clearing a sight triangle so that a driver has adequate visibility means that vegetation, trees, and obstacles be removed to the extent that a driver can clearly ascertain the presence of a train. Clearing a sight triangle does not mean that everything within the triangle must be removed.

Subp. 2. **Signs and active warning devices in place.** Before a new grade crossing or private crossing is opened for use, the rail carrier, road authority, or property owner shall make certain that the appropriate warning signs and active warning devices are in place and operating properly.

Subp. 3. **Visibility standards.** Possible visibility obstructions include, but are not limited to, trees, vegetation, snow, crops, structures, utility poles, parked vehicles, parked rail equipment, signs other than those needed for traffic control, stockpiles of materials, and angle of crossing. Visibility obstructions must be removed according to the following:

A. For a grade crossing or private crossing with active warning devices and gates, the road authority or private crossing owner shall clear visibility obstructions so that all

railroad advance warning signs are clearly visible from the roadway and the active warning devices are visible to a driver that is approaching the crossing at a distance from the crossing in which the vehicle can safely be brought to a stop before reaching the crossing. The rail carrier shall not park rail equipment on the portion of the track that would activate the active warning devices.

B. For a grade crossing or private crossing with only active warning devices or stop signs, the road authority or private crossing owner shall clear visibility obstructions as described in item A. The rail carrier and road authority or private crossing owner shall clear their respective rights-of-way within the stopped vehicle sight triangle as determined by the AASHTO design manual for a train traveling at the highest allowable speed at the crossing. The rail carrier shall not park rail equipment on the portion of the track that would activate the active warning devices.

C. For a grade crossing with crossbucks only, the road authority shall clear visibility obstructions as described in item A, and clear remaining right-of-way that is within the moving vehicle sight triangle as determined by the AASHTO design manual for trains and vehicles traveling at their highest allowable speed at the crossing. The rail carrier shall also clear its right-of-way that lies within the determined sight triangle. The sight triangle may contain property other than that belonging to the road authority and the rail carrier. This property must be cleared by the property owner in order to provide an adequate view of oncoming trains.

Subp. 4. **Alternatives.** If visibility standards cannot be achieved for a crossing with its existing warning system, a different warning system may be substituted if the visibility standards for the crossing can be met in such a way as to preserve safety. For example, if the visibility standards for a crossing with crossbucks cannot be achieved, adequate visibility may be achieved with an addition of a stop sign, an active warning device, or an active warning device with a gate. Other alternatives include, but are not limited to, lowering the vehicle speed, the train speed, or both; using a flagger; or closing the crossing and redirecting the traffic to another crossing.

Statutory Authority: *MS s 218.071; 219.073; 219.165; 219.17; 219.384; 222.50; 222.58; 222.63*

History: *23 SR 524*

SIGNS, SIGNALS, OTHER SAFETY MEASURES

8830.0400 SIGNS.

Signs used on public roadways in Minnesota must comply with the MMUTCD. Sign number designations shown in this chapter refer to the MMUTCD. Requests for clarification, interpretation, or modification of the MMUTCD must be addressed to: Commissioner of Transportation, Mn/DOT, 395 John Ireland Boulevard, Saint Paul, Minnesota 55155, and marked for the attention of the Office of Traffic Engineering. Requests that require action at the national level will be forwarded to the FHWA with an appropriate recommendation by the commissioner.

Full scale drawings of the standard signs illustrated in the MMUTCD, including the standards, symbols, and alphabets used on the signs, are available from the Office of Traffic Engineering, Mn/DOT, Mail Stop 725, 395 John Ireland Boulevard, Saint Paul, Minnesota 55155.

Statutory Authority: *MS s 218.071; 219.073; 219.165; 219.17; 219.384; 222.50; 222.58; 222.63*

History: *23 SR 524*

8830.0500 CROSSBUCK SIGN.

Subpart 1. **Design.** The crossbuck sign, numbered R15-1, must be reflectorized white with the words "RAILROAD CROSSING" in black lettering. If there are two or more

8830.0500 RAILROADS

1272

tracks, including sidings, the number of tracks must be shown on an auxiliary sign, numbered R15-2, of inverted "T" shape, mounted below the crossbuck. Use of the crossbuck and the auxiliary sign, both shown in part 8830.9911, must comply with the MMUTCD and part 8830.9901, subpart 1.

The crossbuck sign must be constructed of four-foot (1.2-meter), 90-degree blades of a material that meets or exceeds the physical properties of metal, and, at nonsignalized grade crossings, must be mounted on a post that meets the breakaway criteria of the Standard Specifications for Structural Supports for Highway Signs, Luminaires and Traffic Signals manual.

Subp. 1a. **Reflectorization.** By January 1, 1997, crossbucks at nonsignalized grade crossings must be double-faced, with both sides having a reflectorized white background with black lettering, to display the message "RAILROAD CROSSING" to both approaches to the grade crossing. A reflectorized strip of at least two inches (50 millimeters) by 48 inches (1,200 millimeters) will be placed on aluminum sheeting or an equivalent material and mounted on the back of the crossbuck posts, one foot (0.3 meter) above the top of the track and in the center of the post.

Crossbucks at signalized grade crossings must be either:

A. single-faced, with one side having a reflectorized white background with black lettering to display the message "RAILROAD CROSSING" to the approach to the grade crossing, and the other side having a reflectorized strip of at least two inches (50 millimeters) by 48 inches (1,200 millimeters) centered on the back of each blade; or

B. double-faced, with both sides having a reflectorized white background with black lettering, to display the message "RAILROAD CROSSING" to both approaches to the grade crossing.

After a crossbuck reflectorized with wide-angle, prismatic, retroreflective sheeting or with a material that is equivalent is installed, future replacement of that crossbuck by the rail carrier must be to at least the same level of reflectorization.

Subp. 2. **Location, installation, and maintenance.** The crossbuck sign must be furnished, installed, maintained, and paid for by the rail carrier. An additional crossbuck sign must be installed when there is more than one track and the tracks are separated by 100 feet (30 meters) or more, as measured from the center of each track along the center line of the roadway, unless the commissioner determines that it is not physically possible to make such an installation. Crossbuck signs must be located in compliance with the MMUTCD and part 8830.9901, subpart 1.

Subp. 3. [Repealed, 23 SR 524]

Statutory Authority: *MS s 218.071; 219.073; 219.165; 219.17; 219.384; 222.50; 222.58; 222.63*

History: 23 SR 524

8830.0600 ADVANCE-WARNING SIGNS.

Subpart 1. **Where signs are used.** Use of railroad advance-warning signs, numbered W10-1, W10-2, W10-3, and W10-4 and shown in part 8830.9921, must comply with the MMUTCD.

The W10-2, W10-3, and W10-4 signs may be installed on roadways that are parallel to tracks to warn a motorist making a turn that a grade crossing is ahead.

The installation, maintenance, and costs of railroad advance-warning signs are responsibilities of the road authority.

Subp. 2. [Repealed, 23 SR 524]

Subp. 3. **Reflectorization.** By January 1, 1997, all existing railroad advance-warning signs will be replaced with advance-warning signs that are reflectorized with wide-angle, prismatic, retroreflective sheeting or its equivalent.

After a railroad advance-warning sign reflectorized with wide-angle, prismatic, retroreflective sheeting or its equivalent is installed, future replacement of that railroad advance-warning sign by the road authority must be to at least the same level of reflectorization.

Statutory Authority: *MS s 218.071; 219.073; 219.165; 219.17; 219.384; 222.50; 222.58; 222.63*

History: *23 SR 524*

8830.0700 SUPPLEMENTARY ADVANCE-WARNING SIGNS.

Subpart 1. **Where signs are used.** Mn/DOT has adopted supplementary railroad advance-warning signs numbered W10-X1, W10-X2, W10-X3, and W13-1, as described in this part. These signs are intended for use in advance of grade crossings where neither active warning devices nor stop signs have been installed and where conditions indicate the need for additional advance warning supplementing that provided by the W10-1 circular railroad advance-warning sign. The use of these signs must be based on investigation by the road authority or the commissioner of conditions at the grade crossing, such as train and vehicle speeds, sight distractions or obstructions, stopping distances, and similar criteria.

The installation, maintenance, and costs of supplementary railroad advance-warning signs are responsibilities of the road authority.

Subp. 1a. **Reflectorization.** By January 1, 1997, all existing supplementary railroad advance-warning signs will be replaced with supplementary advance-warning signs that are reflectorized with wide-angle, prismatic, retroreflective sheeting or with a material that is equivalent.

After a supplementary railroad advance-warning sign reflectorized with wide-angle, prismatic, retroreflective sheeting or with an equivalent material is installed, future replacement of that supplementary railroad advance-warning sign by the road authority must be to at least the same level of reflectorization.

Subp. 2. **Preceded by advance-warning sign.** The supplementary advance-warning signs may be used individually or in logical sequence, but must always be preceded on the approach by the W10-1 sign, which is the initial and primary warning sign to be installed at grade crossings.

Subp. 3. **Intended functions of signs.** Supplementary advance-warning signs alert motorists as follows:

A. The track-angle sign, numbered W10-X1 and shown in part 8830.9931, subpart 1, shows that the track crosses the roadway at a skew, and alerts the motorist that extra care may be needed to ascertain whether trains are approaching. It must display a track symbol at 45 degrees left or right, depending if it's a left skew or right skew.

B. The blind-crossing sign, numbered W10-X2 and shown in part 8830.9931, subpart 2, warns of sight obstructions at the grade crossing area and calls for added vigilance on the part of the motorist.

C. The look for trains sign, numbered W10-X3 and shown in part 8830.9931, subpart 3, may follow the blind-crossing sign or other advance-warning sign for additional emphasis by providing a reminder that it is the motorist's obligation to ascertain whether or not it is safe to proceed over the grade crossing.

D. Advisory speed plates, numbered W13-1, may be mounted beneath a railroad advance-warning sign to indicate the safe vehicle-approach speed to the grade crossing.

Subp. 4. [Renumbered subp. 3, item B]

Subp. 5. [Renumbered subp. 3, item C]

Subp. 6. [Renumbered subp. 3, item D]

8830.0700 RAILROADS

1274

Subp. 7. [Repealed, 23 SR 524]

Statutory Authority: *MS s 218.071; 219.073; 219.165; 219.17; 219.384; 222.50; 222.58; 222.63*

History: *17 SR 1279; 23 SR 524*

8830.0750 OTHER REGULATORY SIGNS.

Subpart 1. **Exempt-crossing signs.** At locations that comply with Minnesota Statutes, section 169.28, subdivision 2, an exempt-crossing sign, numbered R15-3 and shown in part 8830.9941, subpart 1, bearing the word "exempt" may be used below the crossbuck and track signs at the grade crossing, and an exempt-crossing sign, numbered W10-1a and shown in part 8830.9941, subpart 1, may be used below the railroad advance-warning sign. These regulatory signs are to inform drivers of vehicles carrying passengers for hire, school buses carrying children, or vehicles carrying flammable or hazardous materials that a stop is not required at certain designated grade crossings, except when a train, locomotive, or other railroad equipment is approaching or occupying the crossing or the driver's view of the sign is blocked.

Any individual, public agency, or private entity, including a rail carrier, may submit a request to the commissioner for installation of exempt-crossing signs. The use of exempt-crossing signs must be authorized by the commissioner at grade crossings that comply with the standards in Minnesota Statutes, section 169.28, subdivision 2. The road authority shall install an exempt-crossing sign below the railroad advance-warning sign. The rail carrier shall install an exempt-crossing sign below the crossbuck and track signs.

Subp. 2. **"Do not stop on tracks" sign.** Use of the "do not stop on tracks" sign, numbered R8-8 and shown in part 8830.9941, subpart 3, must comply with the MMUTCD.

Statutory Authority: *MS s 218.071; 219.073; 219.165; 219.17; 219.384; 222.50; 222.58; 222.63*

History: *23 SR 524*

8830.0800 STOP SIGNS.

Subpart 1. **Location.** The installation of stop signs, numbered R1-1, at a grade crossing must be authorized by the commissioner in accordance with Minnesota Statutes, section 219.20. The use of stop signs at a grade crossing must comply with the MMUTCD.

Subp. 2. **Size.** The standard size of the stop sign used at grade crossings is 36 inches (900 millimeters) by 36 inches (900 millimeters). Where the commissioner determines that greater emphasis or visibility is desired, a larger size is recommended and may be used.

Subp. 3. **Installation and maintenance.** A stop sign must be mounted on the crossbuck, in accordance with part 8830.9901, subpart 2. The installation, maintenance, and costs of the stop sign are responsibilities of the rail carrier.

Subp. 4. **"Stop ahead" sign.** The road authority shall install a "stop ahead" sign, numbered W3-1a and shown in part 8830.9941, subpart 2, in advance of the stop sign. The installation, maintenance, and costs of the "stop ahead" sign are responsibilities of the road authority.

Subp. 5. **Reflectorization.** By January 1, 1997, existing stop signs and "stop ahead" signs at grade crossings will be replaced with stop signs that are reflectorized with wide-angle, prismatic, retroreflective sheeting or with a material that is equivalent.

After a stop sign or "stop ahead" sign reflectorized with wide-angle, prismatic, retroreflective sheeting or its equivalent is installed, future replacement of that stop sign by the rail carrier or "stop ahead" sign by the road authority must be to at least the same level of reflectorization.

Statutory Authority: *MS s 218.071; 219.073; 219.165; 219.17; 219.20; 219.384; 222.50; 222.58; 222.63*

History: *23 SR 524*

8830.0900 PAVEMENT MARKINGS.

The design and placement of grade crossing pavement markings must comply with the MMUTCD. Installation, maintenance, and costs of pavement markings are the responsibilities of the road authority.

Statutory Authority: *MS s 218.071; 219.073; 219.165; 219.17; 219.384; 222.50; 222.58; 222.63*

History: *23 SR 524*

8830.1000 ACTIVE WARNING DEVICES; STANDARDS, USE, ALTERATION, REMOVAL.

Subpart 1. **When active warning device needed.** Active warning devices are used to advise motorists of the approach or presence of trains. At a grade crossing where the commissioner concludes that active warning devices are needed in addition to that provided by signs, the commissioner shall determine which devices are appropriate for the grade crossing. In determining which devices are appropriate for the grade crossing, the commissioner shall consider the type of roadway, volume of trains and vehicles per day, and visibility standards. These active warning devices must comply with part 8830.9901, subparts 3, 4, and 5, and be approved under part 8830.2125.

Subp. 1a. **Standards.** Except when modified and supplemented by parts 8830.1000 to 8830.3400, future modifications, replacements, and installations of active warning devices at grade crossings made after September 8, 1998, must be made in compliance with the applicable parts of both the AREMA signal manual and the MMUTCD.

Subp. 1b. **Use of active warning device.** Active warning devices of the type described in this chapter may only be installed at grade crossings as a warning of the approach of trains. These devices may not be used for any other purpose and may only be used upon authorization of the commissioner in accordance with part 8830.2125.

Subp. 2. **Alteration of active warning device.** No active warning device including its control circuit may be altered to be substantially different from the plan that was previously approved for the active warning device under part 8830.2125, without prior approval of the commissioner. In no case shall alterations be made that continue the use of control circuits or active warning devices when to do so creates an unsafe or hazardous condition.

Subp. 3. [Repealed, 23 SR 524]

Subp. 4. **Removing active warning device.** If a rail carrier or road authority decides that an in-place active warning device at a grade crossing is no longer needed, it may submit a request to the commissioner for approval to remove the active warning device. The commissioner shall investigate safety conditions at the crossing and determine if removal is appropriate. On determining that an active warning device may be removed based on the exposure of vehicles to trains at the grade crossing, the commissioner shall direct the rail carrier to remove the active warning device.

The treatment of active warning devices at abandoned grade crossings is governed by part 8830.2750.

Statutory Authority: *MS s 218.071; 219.073; 219.165; 219.17; 219.384; 222.50; 222.58; 222.63*

History: *23 SR 524*

8830.1100 [Repealed, 23 SR 524]**8830.1200 OPERATION OF ACTIVE WARNING DEVICE; CONTROLS.**

Subpart 1. **Time requirements.** At signalized grade crossings, the active warning devices must operate for at least 20 seconds before a train's arrival at the crossing.

Where the distance from the active warning device to the point where a vehicle will clear the farthest track is more than 35 feet (10.7 meters), the 20-second time requirement

8830.1200 RAILROADS

1276

must be increased. The distance should be measured parallel to the center line of the roadway. The rate of increase must be one second for each additional ten feet (three meters) of travel to allow slow-moving roadway vehicles to clear the farthest track.

Subp. 2. **Design compliance.** Warning device controls, including electric, electronic, and mechanical methods, must comply with the AREMA signal manual, insofar as it applies, and must be so designed that if a part fails, the device will provide the warning normally provided when a train approaches the grade crossing.

Subp. 3. **Suspending operation.** If means are provided to suspend operation of an active warning device during intervals when trains make regular operating stops or perform switching operations on approach circuits, the active warning device controls must be designed so that train movements on other tracks included in the warning device system activate the warning device before a train reaches the grade crossing. Automatic control of warning devices, activated by approaching trains on tracks other than the track on which the train has stopped or is performing switching operations, must take precedence over any feature provided to suspend operation.

Subp. 4. **Manual control.** If a manual supervisory control of active warning devices is provided in addition to automatic controls:

A. the automatic control, activated by approaching trains on tracks other than that for which manual control has been made effective, must take precedence over the manual control;

B. means must be provided to restore the controls to automatic operation; and

C. means must be provided to prevent manual operation by unauthorized persons.

Subp. 5. **Track circuits.** Tracks over grade crossings with active warning devices must be provided with track circuits, unless the commissioner specifically exempts the crossing in question based on train operation characteristics.

Where train speeds on a given track vary by more than 20 miles per hour (30 kilometers per hour) under normal operation and volume of railroad and roadway traffic warrants, special devices or circuits must be installed to provide consistent warning time for train movements. Special control features must be used to eliminate the effects of station stops and switching operations within approach-control circuits. Wraparound or equivalent circuits may be required with stand-alone, motion-sensitive control equipment.

Subp. 6. **Indication of power interruption.** A "power off" indicator, or equivalent device or method, must be installed for each active warning device system to show that a transfer from the primary power source to a secondary power source has taken place. This "power off" indicator must be visible from the outside of the control cabinet or visible through some other method so that notice is provided indicating that a transfer in power source has taken place and maintenance is required.

Statutory Authority: *MS s 218.071; 219.073; 219.165; 219.17; 219.384; 222.50; 222.58; 222.63*

History: 23 SR 524

8830.1300 Subpart 1. [Renumbered 8830.1200, subp. 2]

Subp. 2. [Renumbered 8830.1200, subp. 3]

Subp. 3. [Renumbered 8830.1200, subp. 4]

Subp. 4. [Renumbered 8830.1200, subp. 5]

Subp. 5. [Repealed, 23 SR 524]

8830.1400 FLASHING LIGHT UNITS.

Subpart 1. **Standard.** Flashing light units consist of two horizontally mounted red lights flashing alternately at predetermined levels. Design criteria for flashing light units must comply with the AREMA signal manual.

Subp. 2. **Horizontal and vertical installation.** Flashing light units must be mounted in accordance with the MMUTCD. Use of cantilevered flashing light units that are mounted on the arm projecting over the roadway must comply with the MMUTCD.

Subp. 3. **Size and design.** Lamp units must be 12 inches (300 millimeters) in diameter, must be hooded to shade them from the sun but not shielded at the sides to impair close-in indication, and must have nonreflecting black backgrounds 20 to 24 inches (500 to 600 millimeters) in diameter. The light units must flash alternately. The number of flashes per minute for an incandescent-type lamp must comply with the MMUTCD. Lamps must be illuminated approximately the same length of time.

Subp. 4. **Alignment.** Alignment of flashing light units must be accomplished by the rail carrier in accordance with the recommended practice set forth in Code of Federal Regulations, title 49, section 234.217, paragraph (a), as amended.

Statutory Authority: *MS s 218.071; 219.073; 219.165; 219.17; 219.384; 222.50; 222.58; 222.63*

History: *23 SR 524*

8830.1500 BELLS.

Subpart 1. **Use required; exception.** A grade-crossing bell, when installed, is used to provide an audible warning and serves as a supplement to an active warning device. Bells must be used at all grade crossings with active warning devices. Requests for exceptions to this requirement must be submitted to the commissioner by the road authority. The commissioner shall grant an exception only at a grade crossing that is not used by bicyclists or pedestrians.

Subp. 2. **Function requirements.** The bell must sound a warning during the time the flashing light units are operating, except it may be silenced when the head end of the train reaches the crossing or when the gate arm has descended to within ten degrees of horizontal when gates are used.

Subp. 3. **Standard.** When installing bells, the rail carrier shall comply with the AREMA signal manual.

Statutory Authority: *MS s 218.071; 219.073; 219.165; 219.17; 219.384; 222.50; 222.58; 222.63*

History: *23 SR 524*

8830.1525 AUTOMATIC GATES.

Subpart 1. **When automatic gate needed.** An automatic gate, when installed, serves as a supplement to an active warning device and, when indicating the approach of a train, must present toward approaching roadway traffic the aspect of a fully reflectorized red and white-striped arm equipped with red lights either being lowered or at rest in the horizontal position across the lanes used by traffic approaching the grade crossing. See part 8830.9901, subpart 5.

Subp. 2. **Use of automatic gate.** When used, crossing gates must extend over the traveled roadway within one foot (0.3 meter) of the roadway's center line or less to block the lanes used by traffic approaching the grade crossing.

Subp. 3. **Gate arm standards.** A gate arm must be equipped with at least three red lamps arranged to shine in both directions along the roadway when the gate arm is in a 90-degree position with respect to the roadway. The gate arm, when in the raised position, must not obstruct or interfere with roadway traffic. The gate arm must be striped on both sides with 16-inch (400-millimeter) alternate diagonal reflectorized stripes of red and white. When in the horizontal position, the bottom of the gate arm must not be less than three feet

8830.1525 RAILROADS

1278

and six inches (1.07 meters) or more than four feet and six inches (1.4 meters) above the crown of the roadway.

Statutory Authority: *MS s 218.071; 219.073; 219.165; 219.17; 219.384; 222.50; 222.58; 222.63*

History: *23 SR 524*

8830.1550 GATE OPERATION AND CONTROL.

Subpart 1. **Functional requirements.** The gate arms must uniformly and smoothly complete movements, and be securely held when in the raised position. Gate-arm lights must operate in conjunction with the active warning device at all times. The light nearest the tip of the arm must burn steadily and two lights must flash alternately in unison with the lights on the active warning device. The gate controls must be so designed that if the arms strike an object while being lowered, they will readily stop, and on removal of the obstruction will assume the proper position. The gate arm must start its downward motion not less than three seconds after the lights on the active warning device start to operate. The commissioner may require a longer time than three seconds if an engineering study based on vehicle operations so concludes. The gate arm must reach the horizontal position before arrival of a train and remain in that position as long as part of the train occupies the grade crossing.

The gate controls must be designed to ensure proper operation during unfavorable weather conditions.

Subp. 2. **Operational failure.** If out of order, the gate arm must assume the horizontal position across the roadway. Circuits must be so arranged that a failure of the gate mechanism to operate as intended will not prevent the lights on the gate arm and the active warning device from operating when a train approaches.

Subp. 3. **Operating gate arm during malfunction.** Where gates are installed, means must be provided to enable personnel designated by the rail carrier to raise the gates when a malfunction in the control system causes the gates to obstruct traffic under conditions other than the approach and movement of a train over the grade crossing.

Statutory Authority: *MS s 218.071; 219.073; 219.165; 219.17; 219.384; 222.50; 222.58; 222.63*

History: *23 SR 524*

8830.1600 PLACEMENT OF ACTIVE WARNING DEVICE.

Subpart 1. **Location of active warning device.** In placing active warning devices, primary consideration must be given to ensuring the proper visibility of the faces of the active warning devices. Active warning devices must be located in compliance with the MMUTCD and in accordance with part 8830.9901, subparts 6 and 7.

Subp. 2. **Use and location of additional active warning device.** Additional light units or an additional active warning device may be used if the commissioner after an investigation determines that the use of a single active warning device is inadequate to warn all roadway traffic approaching the grade crossing from one direction. Use and location of additional active warning devices must comply with the MMUTCD.

Subp. 3. **Gate arm.** Where local conditions require, such as when the grade crossing is at a skew angle, gate arms may be placed at other than right angles to the roadway.

Subp. 4. **Controller cabinets.** At locations where the roadway speed is 40 miles per hour (60 kilometers per hour) or greater, controller cabinets must be located a minimum of 30 feet (nine meters) clear of the edge of the nearest traffic lane unless precluded by physical features such as steep side slopes. At locations where the roadway speed is less than 40 miles per hour (60 kilometers per hour), controller cabinets must be located in compliance with the MMUTCD.

Subp. 5. **Active warning device foundation.** Active warning device foundations must be located in compliance with the MMUTCD.

Subp. 6. **Active warning device on median.** On medians, active warning device support masts must be located in compliance with the MMUTCD.

Statutory Authority: *MS s 218.071; 219.073; 219.165; 219.17; 219.384; 222.50; 222.58; 222.63*

History: *23 SR 524*

8830.1650 TRAFFIC SIGNAL NEAR GRADE CROSSING.

Subpart 1. **Preemption by active warning device control.** When a grade crossing with an active warning device is within or near a roadway intersection controlled by a traffic signal, the control of the traffic signal must be preempted by the control of the active warning device upon the approach of trains to avoid conflicting aspects of the traffic signal and the active warning device. This preemption feature must establish and maintain the preempted condition while the active warning device is operating. The interconnection must be made to the traffic signals within 200 feet (61 meters) of the crossing.

At grade crossings where train movements are regulated or limited to the extent that active warning devices are not required, preemption of the adjacent signalized roadway intersections may still be desirable to permit nonconflicting roadway traffic to proceed during the time the grade crossing is blocked by a train. The responsible road authority shall determine which traffic signals will be preempted.

Subp. 2. **Preemption sequence.** When the preemption sequence begins, it must at once bring into effect a traffic signal display that will permit all vehicles to clear the tracks before the train reaches the grade crossing.

When the green light is preempted by train operation, a yellow change interval must be inserted in the traffic signal sequence for safety and consistency. The traffic signal must indicate a green light in order to clear traffic off the tracks and give a red light to stop traffic approaching the tracks. After the traffic clears the tracks, the traffic signal may be operated to permit vehicle movements that do not cross the tracks, but must prohibit movements over the tracks.

When the train clears the grade crossing, the traffic signal must return to its designated phase.

Subp. 2a. **Turn restrictions.** At a roadway intersection where the traffic signals are preempted by the approach of a train, the "no turn on red" sign, numbered R10-11a, may be used to prohibit turning movements toward the grade crossing. Use of this sign must comply with the MMUTCD.

Subp. 3. **Phasing and timing of traffic signals.** Where feasible, the location and the phasing and timing of traffic signals near grade crossings must be designed so that vehicles are not required to stop on the tracks, even if this increases the waiting time. The exact nature of the display and the location of the traffic signals to accomplish this will depend on the physical relationship of the tracks to the roadway intersection area.

Subp. 4. **Traffic signal not substituted for active warning device.** Traffic signals must not be used on mainline grade crossings in place of active warning devices. However, at industrial track crossings and other places where train movements are slow, as in switching operations, traffic signals may be used instead of active warning devices to warn motorists of the approach or presence of a train.

Statutory Authority: *MS s 218.071; 219.073; 219.165; 219.17; 219.384; 222.50; 222.58; 222.63*

History: *23 SR 524*

8830.1700 GUARD RAIL.

Subpart 1. **Lateral escape route.** Where local road conditions permit, a lateral escape route to the right of the roadway in advance of the active warning device must be kept free of guard rails or other aboveground obstructions such as walls or fences.

8830.1700 RAILROADS

1280

Subp. 2. **Responsibility for installation, maintenance, and costs.** Installation, maintenance, and costs of guard rails along the roadway are the responsibilities of the road authority. Where guard rails are considered necessary or appropriate by the road authority, rigid non-yielding-type barriers are not to be used for protecting active warning device supports.

In industrial and other areas where roadway traffic travels at 25 miles per hour (40 kilometers per hour) or less and where active warning devices are susceptible to being struck by turning truck traffic, such as in terminal areas, alleys, and warehouse areas, a ring-type guard rail may be installed to provide protection for the active warning device support. Installation, maintenance, and costs of ring-type guard rails are the responsibilities of the rail carrier.

Statutory Authority: *MS s 218.071; 219.073; 219.165; 219.17; 219.384; 222.50; 222.58; 222.63*

History: *23 SR 524*

8830.1800 [Renumbered 8830.1525, subps. 1 and 2]

8830.1900 [Renumbered 8830.1525, subp. 3]

8830.2000 [Renumbered 8830.1550]

8830.2100 [Renumbered 8830.1650]

8830.2125 PLAN APPROVAL FOR ACTIVE WARNING DEVICE.

Subpart 1. **Information required.** Modifications, replacements, and installations of active warning devices at grade crossings must be made in accordance with plans approved by the commissioner.

The following information must be provided by the rail carrier to the commissioner:

A. the grade-crossing inventory number as provided for in part 8830.0300 and the exact location of the grade crossing in terms of rail carrier stationing or distance from the nearest milepost;

B. proper name of the roadway crossing the railroad track, including county, state, or federal highway designations;

C. city where the grade crossing is located or city nearest to the grade crossing;

D. listing of plans, special instructions, data forms, informational reports, and documents sent with the application;

E. reasons for making changes in existing control systems for warning devices;

F. two complete sets of plans;

G. wiring diagram of active warning devices, or if on file, may be referred to;

H. changes of existing active warning device facilities and controls, clearly identified on plans by color code or other suitable means, except that if plans reflect only new work, they need not be colored or otherwise coded;

I. upon request, information necessary to completely analyze the active warning device control system;

J. complete plans with respect to the active warning device control system for the grade crossing involved. When block-signal systems are involved, the block-signal controls incorporated in the active warning device control system must be shown to the extent applicable;

K. electronic equipment adequately defined by numerical or other designation supplied by the manufacturer and the name of the manufacturer, so that complete functional and performance characteristics of the active warning device control system can be accurately determined and evaluated;

L. frequency of audio frequency track circuits and other audio equipment shown on the plans;

M. when electronic control equipment consisting of a self-contained unit arranged for incorporation within the active warning device control system is employed and identified only by a box symbol with identifiable terminals within the control circuit diagram, the name of the manufacturer and adequate information to enable accurate determination of the circuits within the self-contained unit, including:

(1) if the circuits are published by the manufacturer of the equipment as a coherent control system, reference to type, model, or other identifying means; or

(2) if the circuits are not published by the manufacturer as a complete and coherent system, copies of the circuits to be employed and a block diagram or other means of determining how they will be related;

N. definitions of special symbols or nomenclature used only by the rail carrier and not found in the AREMA signal manual, publications of manufacturers of active warning device equipment, or other generally recognized sources of information in the rail industry;

O. the length of approach track sections, shown on the plans;

P. the length of island track circuits shown on the plans;

Q. the method of calculation employed by the rail carrier in determining the anticipated warning time for a train approaching the grade crossing at average maximum authorized speed, the active warning device system reaction time, the over-speed tolerance, if any, and any other factors considered;

R. ampere hour capacity of battery stated on the plans;

S. supplementary supporting information when necessary to clarify and support special design features of the active warning device controls or active warning devices, which may consist of, but is not limited to:

(1) daily traffic volume and peak traffic density of motor vehicles over the grade crossing, if this information is available from the road authority;

(2) daily traffic volume and peak traffic density of train movements over the grade crossing;

(3) special operating instructions that apply to the warning devices at the grade crossing or indirectly affect them; and

(4) general operating rules effective in the design of the control system for the active warning devices; and

T. when the control system for roadway intersection traffic signals is to be interconnected with the control system for active warning devices at a grade crossing:

(1) a plan showing how the electrical interconnection will be made;

(2) a sequence chart approved by the state and local authorities concerned, showing the operating sequences possible for the traffic signals; and

(3) a dimensioned or scale plan drawing showing the location of the traffic signals at the roadway intersection and the active warning devices at the grade crossing.

The road authority shall provide the traffic signal plans and the rail carrier shall provide the active warning device plans. Plan submittals will be coordinated by the commissioner.

Subp. 2. **Standards of review.** The commissioner will review the plans for proper location of active warning devices in accordance with the MMUTCD, provisions to provide the required warning to motorists, and provisions to prevent unnecessary operation or

8830.2125 RAILROADS

1282

excessive operation of the active warning devices. When approved, the commissioner will return one complete set of plans to the rail carrier.

Statutory Authority: *MS s 218.071; 219.073; 219.165; 219.17; 219.384; 222.50; 222.58; 222.63*

History: *23 SR 524*

8830.2150 OPERATING LICENSE.

Upon installation or modification of an active warning device system and approval with or without an inspection by the commissioner, an operating license will be issued by the commissioner to the operating rail carrier in accordance with part 8830.9991.

Statutory Authority: *MS s 218.071; 219.073; 219.165; 219.17; 219.384; 222.50; 222.58; 222.63*

History: *23 SR 524*

8830.2200 [Renumbered 8830.2425]

8830.2300 [Renumbered 8830.2125]

8830.2400 [Renumbered 8830.2150]

8830.2425 MAINTAINING, OPERATING ACTIVE WARNING DEVICES.

Maintenance and operation of active warning devices at grade crossings are the responsibilities of the operating rail carrier or owner of the tracks, and are to be performed in accordance with the rail carrier's written maintenance, inspection, and testing procedures that are filed and updated with the FRA under Code of Federal Regulations, title 49, sections 234.1 to 234.273, as amended.

Statutory Authority: *MS s 218.071; 219.073; 219.165; 219.17; 219.384; 222.50; 222.58; 222.63*

History: *23 SR 524*

8830.2500 FLAGGER.

A flagger is a rail carrier employee other than a train crew member who, as a part of normal duties, could be expected to direct roadway traffic. At a grade crossing where a flagger is temporarily stationed by the rail carrier to direct roadway traffic, or where a flagger is temporarily stationed as provided for in the operating license, shown in part 8830.9991, or at a grade crossing designated by the commissioner as a flagged crossing where all train movements over the grade crossing are to be preceded by a member of the train crew, items A and B apply.

A. While directing traffic, the flagger shall wear garments and be equipped as directed under "appropriately equipped flagger" in Code of Federal Regulations, title 49, section 234.5, as amended.

B. Flaggers shall direct roadway traffic only when there is potential danger at the grade crossing, such as when an active warning device is malfunctioning, a train is approaching the grade crossing, or the grade crossing is occupied by railroad equipment.

When a flagger is needed due to the malfunction of an active warning device, the flagger's activities and responsibilities must be as directed under Code of Federal Regulations, title 49, sections 234.105 and 234.107, as amended.

Statutory Authority: *MS s 218.071; 219.073; 219.165; 219.17; 219.384; 222.50; 222.58; 222.63*

History: *17 SR 1279; 23 SR 524*

8830.2600 [Repealed, 23 SR 524]

GRADE CROSSINGS

8830.2650 MAINTAINING GRADE CROSSING SURFACE.

The responsibility for maintaining grade crossing surfaces is governed by Minnesota Statutes, section 219.071.

A rail carrier shall not close a roadway for 15 minutes or longer to perform maintenance at a grade crossing without giving advance notice to the road authority so that the road authority can notify the public of the closure and, where possible, identify alternate routes.

Statutory Authority: *MS s 218.071; 219.073; 219.165; 219.17; 219.384; 222.50; 222.58; 222.63*

History: *23 SR 524*

8830.2700 ESTABLISHING, RELOCATING, CHANGING GRADE CROSSING.

Subpart 1. **When approval required.** New grade crossings and relocations of existing grade crossings must be approved by the commissioner. Changes to existing grade crossings, as described in subpart 6, do not require approval.

Subp. 2. **Design standards.** New grade crossings and relocated grade crossings must meet the design standards of the AASHTO design manual and comply with the MMUTCD.

Subp. 3. **When agreement reached, application required.** When the road authority and the rail carrier agree upon the establishment of a new grade crossing or the relocation of an existing grade crossing, an application must be filed with the commissioner containing the information in subpart 5. Applications for new roadways and relocations of existing roadways across existing railroad tracks must be made by the road authority that will have jurisdiction over the roadway. Applications for new railroad tracks and relocations of existing railroad tracks across existing roadways must be made by the owner of the track or the operating rail carrier, or in the case of a spur track, jointly by the operating rail carrier and the owner of the spur track.

The commissioner may accept, reject, or modify the provisions of the application based on criteria in subpart 5 and part 8830.2710.

Subp. 4. **When agreement not reached, petition required.** When the road authority and the rail carrier cannot agree upon the establishment of a new grade crossing, either party may file a petition with the commissioner, submitting the matter to the commissioner for determination under Minnesota Statutes, section 219.072. The petition must be accompanied by an application for the new grade crossing, containing the information required in subpart 5.

When the road authority and the rail carrier cannot agree upon the relocation of a grade crossing, either party may file a petition with the commissioner for determination under Minnesota Statutes, section 219.074, subdivision 1. The petition must be accompanied by an application for the relocated grade crossing, containing the information in subpart 5.

Subp. 5. **Application content requirements.** Applications must be accompanied by relevant documents, data, and material that demonstrate the need for the grade crossing, how safety concerns are addressed, and how the grade crossing affects the public interest. The filing must contain, at a minimum, the following information:

- A. the name of the rail carrier or owner of the track;
- B. the name of the road authority;
- C. maps showing:
 - (1) the general and specific location of the proposed grade crossing;
 - (2) existing and projected patterns of traffic for:
 - (a) emergency vehicles;
 - (b) school buses;
 - (c) vehicles carrying hazardous materials; and

8830.2700 RAILROADS

1284

- (d) trucks;
- (3) distances to nearest roadway-roadway intersection in both directions, and type of traffic signs and signals at each intersection; and
- (4) distances to nearest railroad-roadway intersection in both directions, and type of warning devices and signs at each intersection;
- D. plans showing:
 - (1) grade of roadway;
 - (2) grade of tracks;
 - (3) alignment of roadway;
 - (4) alignment of tracks;
 - (5) present property limits and proposed property limits of the road authority and the rail carrier; and
 - (6) locations of objects that could obstruct a driver's view of the grade crossing or an oncoming train;
- E. the proposed schedule of construction;
- F. details of construction;
- G. proposed use by applicant;
- H. existing and projected traffic volumes and speeds, and train frequency, types of trains, whether passenger, freight, or switching, and speeds;
- I. suggested signs or active warning devices; and
- J. a list of considered alternatives to the proposed grade crossing.

Subp. 6. **Changes to existing grade crossing.** Repair and maintenance of existing grade crossings and modifications of existing grade crossings that (1) are agreed to by the road authority and the rail carrier, (2) do not change the profile or alignment of the roadway or the railroad tracks, and (3) do not require the construction of additional roadway lanes, do not require approval by the commissioner.

A pavement overlay or track raise, if agreed to by the road authority and the rail carrier, is not considered a profile change and does not require approval by the commissioner.

Subp. 7. **Changes to active warning device.** Notwithstanding subpart 6, modifications of active warning devices must be approved under part 8830.2125.

Statutory Authority: *MS s 218.071; 219.072; 219.073; 219.165; 219.17; 219.384; 222.50; 222.58; 222.63*

History: *23 SR 524*

8830.2710 ESTABLISHING, RELOCATING GRADE CROSSING; CRITERIA.

Subpart 1. **Candidate for establishment or relocation.** A proposed new grade crossing or proposed relocation of an existing grade crossing must meet at least one of the criteria in items A to E to be considered for establishment or relocation.

- A. It will provide access to two or more private properties or to public lands, that have no alternate access route.
- B. It will provide access where an alternate grade crossing or grade separation is not available within one-quarter mile (0.4 kilometer) in an urban area or one mile (1.6 kilometers) in a rural area and will have an ADT of:
 - (1) 750 vehicles or more, if located in an urban area; or
 - (2) 150 vehicles or more, in a rural area.
- C. It will consolidate two or more existing grade crossings.
- D. It is required by the construction of a new rail line.

E. It will increase public safety by eliminating another safety problem area such as an accident-prone roadway intersection.

Subp. 2. **Alternatives analysis.** A road authority or rail carrier that proposes a new grade crossing or the relocation of an existing grade crossing must perform an analysis of alternatives to the proposed new or relocated grade crossing.

Subp. 3. **Considerations.** The commissioner shall consider the following factors in determining whether a grade crossing may be established or relocated:

- A. use of the grade crossing by emergency vehicles;
- B. use of the grade crossing by vehicles carrying hazardous materials, vehicles carrying passengers for hire, and school buses;
- C. conformity of sight distances with the AASHTO design manual;
- D. alignments of the roadway and the railroad track, and the angle of intersection of those alignments;
- E. profile of the intersection of the roadway and the railroad track, and of the approaches to the intersection;
- F. distance and travel time to an alternate crossing;
- G. distance from the grade crossing to adjacent intersections or driveways;
- H. volume of vehicular traffic and operating speed;
- I. volume of train traffic and operating speed;
- J. use of the grade crossing by pedestrians, bicyclists, and recreational users;
- K. type of warning devices proposed;
- L. other factors that might adversely affect the safety of roadway users, pedestrians, bicyclists, and recreational users;
- M. costs and benefits of constructing the grade crossing, and the cost participation that would be required of each of the parties involved, as well as the availability of funds; and
- N. public opinion regarding establishment or relocation of the grade crossing.

Subp. 4. **Responsibility for costs.** The cost of constructing a new grade crossing or relocating an existing grade crossing is the responsibility of the road authority, unless the construction or relocation is the result of an action initiated by the rail carrier. If the new or relocated grade crossing consolidates two or more existing grade crossings, the cost of constructing or relocating the grade crossing must be divided between the road authority and the rail carrier in the same proportion as the accrued benefits and savings.

Statutory Authority: *MS s 218.071; 219.073; 219.165; 219.17; 219.384; 222.50; 222.58; 222.63*

History: *23 SR 524*

8830.2720 VACATING GRADE CROSSING.

Subpart 1. **Candidate for vacation.** A grade crossing is a candidate for vacation under either item A or B.

A. A grade crossing may be vacated if there has been either an accident involving a fatality or two property damage or personal injury accidents within the last five years.

B. A grade crossing may be vacated if:

- (1) an alternate grade crossing or grade separation that provides access to the affected private properties or public lands is available within one-quarter mile (0.4 kilometer) of the crossing in an urban area or one mile (1.6 kilometers) of the crossing in a rural area; and

8830.2720 RAILROADS

1286

- (2) the grade crossing:
- (a) is located in an urban area and has a current ADT of 750 vehicles or less;
 - (b) is located in a rural area and has a current ADT of 150 vehicles or less; or
 - (c) has sight distance obstructions or an alignment that creates unsafe conditions at that grade crossing.

Subp. 2. **Considerations.** The commissioner shall consider the following factors in determining which grade crossings to be vacated:

- A. previous use of the grade crossing by emergency vehicles;
- B. accident history for the last five years;
- C. use of the grade crossing by vehicles carrying hazardous materials, vehicles carrying passengers for hire, and school buses;
- D. sight distances that do not conform with the AASHTO design manual;
- E. alignments of the roadway and the railroad track, and the angle of intersection of those alignments;
- F. profile of the intersection of the roadway and the railroad track, and of the approaches to the intersection;
- G. distance and travel time to an alternate crossing;
- H. distance from the grade crossing to adjacent intersections or driveways;
- I. volume of vehicular traffic and operating speed;
- J. volume of train traffic and operating speed;
- K. use of the grade crossing by pedestrians, bicyclists, and recreational users;
- L. other factors that might adversely affect the safety of roadway users, pedestrians, bicyclists, and recreational users; and
- M. costs and benefits of vacating the grade crossing.

Subp. 3. **Crossing vacation program; priority.** In identifying grade crossings proposed to be vacated under the crossing vacation program established by Minnesota Statutes, section 219.074, subdivision 2, the commissioner shall first evaluate rail lines carrying the highest number of trains and having the highest train speeds.

The commissioner may remove grade crossings proposed for vacation due solely to alignment, sight distance, or other deficiencies from the list if the road authority, at its own expense, corrects the identified deficiencies.

Statutory Authority: *MS s 218.071; 219.073; 219.165; 219.17; 219.384; 222.50; 222.58; 222.63*

History: *23 SR 524*

8830.2730 CONSOLIDATING GRADE CROSSING.

Consolidation of grade crossings occurs when one or more grade crossings are vacated, with the traffic directed to nearby crossings. Standards for vacation are contained in part 8830.2720.

Grade crossings are also consolidated by changing roadway alignments so that two or more roadway alignments with grade crossings are combined into one roadway alignment with one crossing. If the change in alignments results in a new grade crossing, it must meet the criteria in part 8830.2710 and be authorized as provided for in part 8830.2700.

Statutory Authority: *MS s 218.071; 219.073; 219.165; 219.17; 219.384; 222.50; 222.58; 222.63*

History: *23 SR 524*

8830.2740 GRADE SEPARATION AT CROSSING.

Subpart 1. **Candidate for grade separation.** A grade crossing must meet at least one of the criteria in items A to C to be a candidate for grade separation.

A. The train speeds at the crossing are 40 miles per hour (60 kilometers per hour) or greater, the roadway carries four or more lanes of traffic, and either:

(1) the roadway immediately preceding the crossing has a posted speed of 30 miles per hour (50 kilometers per hour) or greater and a current ADT of 5,000 vehicles or more; or

(2) the roadway immediately preceding the crossing has a posted speed of 55 miles per hour (90 kilometers per hour) or greater and a current ADT of 3,000 vehicles or more.

B. There are active warning devices, and there has been a vehicle-train accident at the grade crossing involving a fatality or two property damage or personal injury accidents within the last five years.

C. An increase in public safety would result from construction of the grade separation by eliminating another safety problem area such as an accident-prone roadway intersection.

Subp. 2. **Considerations.** The commissioner shall determine whether a grade separation will be constructed, and, if so, the appropriate location for the grade separation. The commissioner shall consider the following factors related to the crossing in making this determination:

- A. previous use of the crossing by emergency vehicles;
- B. accident history for the last five years;
- C. use of the crossing by vehicles carrying hazardous materials, vehicles carrying passengers for hire, and school buses;
- D. volume of vehicular traffic and operating speed;
- E. volume of train traffic and operating speed;
- F. number of tracks;
- G. vertical and horizontal alignments, and the need for and availability of additional right-of-way;
- H. other grade crossings in the area;
- I. other factors that might adversely affect the safety of roadway users, pedestrians, bicyclists, and recreational users;
- J. costs and benefits of constructing a grade separation and the cost participation that would be required of each of the parties involved, as well as the availability of funds; and
- K. public opinion regarding construction of the grade separation.

Subp. 3. **Approval of structure plans.** Plans for structures that provide grade separations must be approved by the commissioner under part 8830.2800.

Statutory Authority: *MS s 218.071; 219.073; 219.165; 219.17; 219.384; 222.50; 222.58; 222.63*

History: *23 SR 524*

8830.2750 ABANDONED CROSSING.

Subpart 1. **Removing signs and markings.** Where railroad tracks have been abandoned, the related signs and pavement markings must be removed. Removal of the cross-buck sign and signs attached to it is the responsibility of the rail carrier. Removal of advance-warning signs and pavement markings is the responsibility of the road authority.

8830.2750 RAILROADS

1288

Subp. 2. **Active warning device and gate.** When tracks are not in service, in-place gate arms must be removed. In-place active warning device heads must be hooded, turned, or removed to clearly show that they are not in operation. These are the responsibilities of the rail carrier.

Subp. 3. **Use of "tracks out of service" sign.** When a railroad track has been abandoned, and a future need for the track has been identified by the owner of the track, a "tracks out of service" sign, numbered R8-9 and shown in part 8830.9941, subpart 4, must be installed in compliance with the MMUTCD. Use of the "tracks out of service" sign must be authorized by the commissioner. Any individual, public agency, or private entity may submit a request to the commissioner for installing a "tracks out of service" sign. The commissioner will authorize the use of the "tracks out of service" sign upon verification that the tracks are actually out of service. Upon authorization, the commissioner shall order a "tracks out of service" sign to be installed. Installation, maintenance, and costs of this sign are the responsibilities of the road authority.

Subp. 4. **Removing track.** When a track has been abandoned for 180 days or more and no future need for the track has been identified by the owner of the track, the owner of the track shall remove the track structure and related materials at the abandoned grade crossing when required to do so by the road authority. The owner of the track shall then restore the roadway to conform with the roadway sections approaching the abandoned grade crossing, unless otherwise mutually agreed to by the owner of the track and the road authority.

Statutory Authority: *MS s 218.071; 219.073; 219.165; 219.17; 219.384; 222.50; 222.58; 222.63*

History: 23 SR 524

8830.2760 TRAIL AND BICYCLE PATH GRADE CROSSING.

Subpart 1. **Application.** This part applies to trail and bicycle path grade crossings located on property owned by a road authority and located adjacent to a roadway within the roadway right-of-way.

Subp. 2. **Design.** When a trail or bicycle path must cross railroad tracks, the grade crossing must be designed to enhance the safety of the trail or bicycle path user. When possible, the grade crossing must not be located on trail or bicycle path curves or track curves, and the trail or bicycle path must cross the tracks at a right angle. When it is not possible for the trail or bicycle path to cross the tracks at a right angle, the trail or bicycle path must be widened to allow the trail or bicycle path user to cross the tracks at as close to a right angle as possible.

Subp. 3. **Active warning device, sign, and pavement marking.** Active warning devices, signs, and pavement markings used at grade crossings on trails and bicycle paths must comply with the MMUTCD standards for bicycle facilities. Stop signs must be installed at grade crossings on trails and bicycle paths. Pavement markings must be used in advance of grade crossings on paved bicycle paths and, to the extent practicable, on trails.

Installation, maintenance, and costs of signs and pavement markings used at grade crossings on trails and bicycle paths are the responsibilities of the governmental entity having jurisdiction over the trail or bicycle path.

Statutory Authority: *MS s 218.071; 219.073; 219.165; 219.17; 219.384; 222.50; 222.58; 222.63*

History: 23 SR 524

8830.2800 [Renumbered 8910.1000]

8830.2900 [Repealed, 23 SR 524]

CLEARANCES

8830.3000 STRUCTURE AND TRACK CLEARANCES; VARIANCES.

Legal clearances adjacent to, over, and between railroad tracks and clearance exceptions and variances are defined in Minnesota Statutes, sections 219.45 to 219.53, and are depicted in part 8830.9951.

The commissioner may approve permanent clearance variances in accordance with Minnesota Statutes, section 219.47, subdivision 1.

The commissioner may grant temporary clearance variances under Minnesota Statutes, section 219.47, subdivision 2, for encroachments during construction. An application for a temporary variance may be submitted to the commissioner by either the rail carrier or the road authority.

Statutory Authority: *MS s 218.041; 218.071; 219.073; 219.165; 219.17; 219.384; 222.50; 222.58; 222.63*

History: *17 SR 1279; 23 SR 524*

ACCIDENT REPORTS; TRACK SAFETY STANDARDS

8830.3100 RAIL CARRIER ACCIDENT REPORT.

Subpart 1. **Report.** A rail carrier shall provide the commissioner a report of accidents, in accordance with Minnesota Statutes, section 218.031, subdivision 2, paragraph (4). "Accidents" has the meaning given in Code of Federal Regulations, title 49, section 225.5, as amended.

Subp. 2. **Copy sent to commissioner.** Except for items A and B, rail carriers shall provide the commissioner with copies of accident reports in the form, style, and schedule required by the FRA in Code of Federal Regulations, title 49, part 225, as amended.

A. Train or train service accidents, regardless of extent of damage, that occur at a grade crossing must be reported within ten days of the accident, in the form and style required by the FRA.

B. Grade crossing accidents that involve a fatality must be reported within 24 hours of the accident. The notification must include location, time, and type of accident.

Subp. 3. [Repealed, 23 SR 524]

Statutory Authority: *MS s 218.041; 218.071; 219.073; 219.165; 219.17; 219.384; 222.50; 222.58; 222.63*

History: *23 SR 524*

8830.3150 GRADE CROSSING SYSTEM FAILURE, REPORT.

Rail carriers shall provide the commissioner with copies of reports listing instances of grade crossing active warning device system failures in the form, style, and schedule required by the FRA in Code of Federal Regulations, title 49, part 234, as amended.

Statutory Authority: *MS s 218.071; 219.073; 219.165; 219.17; 219.384; 222.50; 222.58; 222.63*

History: *23 SR 524*

8830.3200 TRACK SAFETY STANDARDS.

The track safety standards, found in Code of Federal Regulations, title 49, part 213, as amended, apply to all railroad trackage and are the standards for determination of unsafe trackage.

Statutory Authority: *MS s 218.041; 218.071; 219.073; 219.165; 219.17; 219.384; 222.50; 222.58; 222.63*

History: *23 SR 524*

ACCOUNTING

8830.3300 BILLING.

The Federal-Aid Policy Guide is the basis for rail carriers billing their allocated or agreed-upon shares of their work against a public authority in connection with a project under the jurisdiction of Mn/DOT.

Statutory Authority: *MS s 218.041; 218.071; 219.073; 219.165; 219.17; 219.384; 222.50; 222.58; 222.63*

History: 23 SR 524

8830.3400 ACCOUNTING CLASSIFICATIONS; REPORTS.

Subpart 1. **Classification.** For the purpose of accounting, the commissioner adopts the Surface Transportation Board classifications, including future amendments that may be made by the Surface Transportation Board.

Subp. 2. **Uniform system of accounts.** For projects under the jurisdiction of Mn/DOT, each rail carrier shall maintain its accounts in accordance with the uniform system of accounts prescribed by the Surface Transportation Board in "Uniform Accounting System," United States Code, title 49, section 11142, as amended, or as otherwise approved by the Surface Transportation Board.

Subp. 3. **Reports.** A rail carrier shall submit the following reports to the commissioner:

A. by June 30 of the year following the year on which the report is based, a copy of the annual report form submitted to the Surface Transportation Board;

B. a copy of the annual report to stockholders; and

C. such other information as the Surface Transportation Board may request to evaluate rail carrier operations in the state, such as annual carloadings, annual revenues, and annual costs.

The commissioner shall provide written notification to any rail carrier required to provide this information. The notice must state the information required, the format for reporting the information, and the time period for which the information is to be provided. The commissioner shall provide a reasonable period before the information is due.

Subp. 4. **Confidential data.** For purposes of this part, information is considered confidential when the information collected contains data that is required to be kept confidential by United States Code, title 49, section 11910, as amended.

Statutory Authority: *MS s 218.041; 218.071; 219.073; 219.165; 219.17; 219.384; 222.50; 222.58; 222.63*

History: 23 SR 524

8830.3500 [Repealed, 23 SR 524]

8830.3600 [Renumbered 8910.2000]

8830.3700 [Renumbered 8910.2100]

8830.3800 [Renumbered 8910.3000]

8830.3900 [Renumbered 8910.3100]

8830.5100 Subpart 1. [Repealed, 23 SR 524]

Subp. 2. [Repealed, 23 SR 524]

Subp. 3. [Repealed, 23 SR 524]

Subp. 4. [Repealed, 23 SR 524]

Subp. 5. [Renumbered 8830.0100, subp. 19]

Subp. 6. [Renumbered 8830.0100, subp. 20]

- Subp. 7. [Renumbered 8830.0100, subp. 21]
- Subp. 8. [Repealed, 23 SR 524]
- Subp. 9. [Repealed, 23 SR 524]
- Subp. 10. [Repealed, 23 SR 524]
- Subp. 11. [Repealed, 23 SR 524]
- Subp. 12. [Repealed, 23 SR 524]
- Subp. 13. [Repealed, 23 SR 524]
- Subp. 14. [Repealed, 23 SR 524]
- Subp. 15. [Renumbered 8830.0100, subp. 48]
- Subp. 16. [Repealed, 23 SR 524]
- Subp. 17. [Renumbered 8830.0100, subp. 50]
- Subp. 18. [Repealed, 23 SR 524]

8830.5200 [Repealed, 23 SR 524]

RAIL SERVICE IMPROVEMENT

8830.5300 RAIL REHABILITATION PROJECT.

Subpart 1. **Eligibility.** A rail line, or portions of it, is eligible for rehabilitation funding if:

- A. it does not comply with FRA Class II Track Safety Standards adopted in part 8830.3200, or it does not have the required structural capacity to support rail cars of 263,000 pounds (119.3 metric tons) gross weight;
- B. it is within the physical boundaries of or predominantly serves rail users in Minnesota; and
- C. a contract has been negotiated that meets the requirements of parts 8830.5300 to 8830.5700, and Minnesota Statutes, section 222.50, and, when federal funds are used, the local rail freight assistance program.

Subp. 2. **Priority criteria.** The following criteria govern the priority of projects proposed for funding:

- A. the availability of state or federal program funds;
- B. the probability of the rail line continuing in profitable service after the project is completed;
- C. the costs of the project compared to the benefits resulting from the project;
- D. the level of commitment of a rail carrier and rail users to participate financially in the project;
- E. the significance of the line in relationship to the entire state rail system; and
- F. the impact on state, county, and city access roadways if the funding is not provided.

Subp. 3. **Standards.** Rail line rehabilitation must be performed to the extent that it allows the use of rail cars having a gross weight of 263,000 pounds (119.3 metric tons) and that it allows trains to operate safely at a minimum of FRA Class I Track Safety Standards adopted in part 8830.3200. The commissioner shall approve rehabilitation to an alternate standard only if it meets or exceeds the standards cited in this subpart and will provide the required level of service. The rail line must be maintained to the maintenance and safety levels set forth in the rehabilitation contract.

8830.5300 RAILROADS

1292

Subp. 4. **Project funding.** Funding for rail rehabilitation projects must be computed under item A or B.

A. For rail rehabilitation on a rail line not owned by a regional railroad authority, the division of costs must comply with the following formula:

(1) The commissioner shall make a grant or loan of federal funds; a loan of state funds; or combination grant or loan of federal funds and loan of state funds, of up to 70 percent of the total cost of a project. A grant must not exceed 50 percent of the project cost.

(2) Rail users shall loan the rail carrier a minimum of ten percent of the cost of a project.

(3) The rail carrier shall provide a minimum of 20 percent of the cost of a project, and shall repay the loans from the rail users and the loans of federal and state funds.

B. If a rehabilitation project is on a rail line owned by a Regional Railroad Authority, the division of costs must comply with the following formula:

(1) The commissioner shall make a grant or loan of federal funds; a loan of state funds; or combination grant or loan of federal funds and loan of state funds, of up to 80 percent of the total cost of a project.

(2) Rail users shall loan the Regional Railroad Authority a minimum of ten percent of the total cost of a project.

(3) The Regional Railroad Authority shall provide a minimum of ten percent of the total cost of the project and shall repay the loans from the rail users and the loans of federal and state funds.

C. Participation in a contract by a party may include in-kind participation if agreed to by all parties to the contract. A detailed description and fair market value of all in-kind participation must be clearly defined in the contract.

Subp. 5. **Repayment requirements.** The rail carrier shall reimburse the rail users for funds loaned to it under a formula based on usage of the line, or a predetermined fixed amount. Repayment must be made on terms negotiated between the rail carrier and the rail user and approved by the commissioner.

The rail carrier shall repay the funds loaned to it by the commissioner in accordance with terms negotiated between the rail carrier and the commissioner. Payments must be made on a set schedule and be sufficient to repay the loan within 15 years from the execution of the contract.

The rehabilitation contract must provide for an extension of time if service is stopped or reduced by events beyond the control of the parties to the contract, unless the cessation or reduction is the result of diminished demand for service.

Statutory Authority: *MS s 218.071; 219.073; 219.165; 219.17; 219.384; 222.50; 222.58; 222.63*

History: 23 SR 524

8830.5400 [Repealed, 23 SR 524]

8830.5450 FINANCIAL ASSISTANCE FOR REGIONAL AUTHORITY.

Subpart 1. **Eligibility.** A Regional Railroad Authority is eligible for financial assistance in purchasing a rail line if it meets all of the conditions listed in items A to E.

A. The Regional Railroad Authority is in compliance with the purpose set forth in Minnesota Statutes, section 398.02.

B. Financial analysis shows that the line can operate at a profit.

C. The costs of purchase and necessary rehabilitation will not exceed benefits.

D. The Regional Railroad Authority has the capability of operating the rail line or contracts with an operator acceptable to the commissioner.

E. So long as the purchase assistance loan remains unpaid, the Regional Railroad Authority:

(1) agrees to and does keep title to property purchased by the Regional Railroad Authority; and

(2) does not sell, trade, convey, transfer, or assign any portion of its interest in the property in any manner without previous approval by the commissioner.

Subp. 2. **Financial assistance.** Financial assistance is available to a Regional Railroad Authority for purchasing a rail line under the following conditions.

A. If the line has not been abandoned and is to be used for continued rail service, the commissioner may provide funding for up to 50 percent of the going concern value or the net liquidation value of the line, whichever is less.

B. If the line has been abandoned and is to be used for continued rail service, the commissioner may provide funding for up to 50 percent of the net liquidation value of the line.

C. If the line is abandoned and is to be used for transportation purposes other than rail service, the commissioner may provide funding for up to 50 percent of the value of the underlying property. The value of the property will be determined through negotiation between the Regional Railroad Authority, rail carrier, and commissioner.

D. The percentages shown in items A to C indicate maximum participation by the commissioner. The actual amount of financial assistance will be determined by the availability of funds, the viability of the proposed use, and the participation of the Regional Railroad Authority.

Subp. 3. **Repayment requirements.** The Regional Railroad Authority is not required to repay the funds loaned to it by the commissioner while the rail line remains in operation and is not sold. If operations on the line cease for one year or if the Regional Railroad Authority sells, trades, conveys, transfers, or assigns any portion of its interest in the property, the Regional Railroad Authority shall repay the funds loaned to it by the commissioner in accordance with terms negotiated between the Regional Railroad Authority and the commissioner.

Statutory Authority: *MS s 218.071; 219.073; 219.165; 219.17; 219.384; 222.50; 222.58; 222.63*

History: *23 SR 524*

8830.5500 CAPITAL IMPROVEMENT PROJECT.

Subpart 1. **Eligibility; funding.** The commissioner shall provide funding to rail users from the rail service improvement account for up to 100 percent of the cost of a rail transportation-related capital improvement project under the following conditions:

A. state funds are available;

B. the capital improvement project will benefit the economy of the state and strengthen the financial condition of the associated rail line;

C. the state's interests are protected by sufficient collateral or guarantees; and

D. the commissioner is repaid for funds loaned at a predetermined, fixed amount payable quarterly over a period of not more than ten years.

Subp. 1a. **Priority criteria.** The following criteria govern the priority of capital improvement projects proposed for funding:

A. Highest priority will be given to projects where:

(1) the capital improvement is directly related to an overall rail line rehabilitation or acquisition; and

(2) the loan applicant has made a financial contribution toward rehabilitating or acquiring the line.

8830.5500 RAILROADS

1294

B. Other projects will be given priority in the following order:

- (1) capital improvement projects related to a rail line rehabilitation or acquisition;
- (2) capital improvement projects on any rail line carrying less than 5,000,000 gross tons per mile per year;
- (3) capital improvement projects on a Surface Transportation Board Class Two or Class Three rail line; and
- (4) capital improvement projects on any rail line within the boundaries of Minnesota.

Subp. 2. **Demonstration project.** The commissioner shall provide interest-free funding from the rail service improvement account of up to 100 percent of the total cost of a capital improvement project if the capital improvement is a demonstration project and the following conditions are met:

- A. state funds are available;
- B. the project demonstrates unique methods of improving rail service or alleviating the impact of abandonments that are not in common usage throughout the rail industry and the project has not been previously funded under parts 8830.5300 to 8830.5500;
- C. it is likely that a similar project can be instituted in other locations without the need for public financing; and
- D. the benefits resulting from the project exceed the costs of implementing the project.

The amount of funding assistance will be determined by the availability of funds and the viability of the proposed project.

Statutory Authority: *MS s 218.071; 219.073; 219.165; 219.17; 219.384; 222.50; 222.58; 222.63*

History: *23 SR 524*

8830.5600 INFORMATION REQUIREMENTS.

Subpart 1. **Providing information.** As long as the commissioner has a financial interest in the property of the rail carrier, the rail carrier and rail users shall provide such information as is reasonably necessary for the commissioner to properly evaluate and adequately administer a project under parts 8830.5300 to 8830.5500. This information must include financial data, commodity data, cost data of the project, operations information, information on annual maintenance activities and expenditures, and similar types of data and information.

Subp. 2. [Renumbered 8830.5650, subpart 1]

Subp. 3. [Renumbered 8830.5650, subp. 3]

Statutory Authority: *MS s 218.071; 219.073; 219.165; 219.17; 219.384; 222.50; 222.58; 222.63*

History: *23 SR 524*

8830.5650 CONTRACTS.

Subpart 1. **Contracts; information.** Executed contracts must be the documents used to commit funds and implement projects. Contracts must include:

- A. the description and location of the project;
- B. the appropriate plans, standards, specifications, estimated costs, work schedule, and completion date;
- C. the level of service the rail carrier will provide on the rail line during the contract period, pursuant to United States Code, title 49, section 11121, as amended;

- D. the level of rail line maintenance that will be performed during the period of the contract;
- E. provisions for auditing by the commissioner;
- F. the requirement to comply with all applicable federal regulations when federal funding is involved in the project;
- G. the duration of the contract;
- H. provisions for maintenance and availability of records and audits;
- I. payment and repayment schedules when appropriate;
- J. the amount of funds and any in-kind participation by each party;
- K. the method of administering the contract;
- L. a provision for appropriate recapture of state and federal funds; and
- M. the appropriate remedial action to be taken or penalties to be imposed, or both, for failure to comply with the terms of the contract.

Subp. 2. **Bidding process.** The bidding process for contracts for rail rehabilitation projects must comply with "Procurements," Code of Federal Regulations, title 49, section 18.36, as amended. This condition may be waived if the owner of the rail line that is to be the subject of a rehabilitation contract has an established labor agreement with an industry-wide rail labor union that specifically prohibits the use of outside contractors.

Subp. 3. **Contracts; exceptions.** Exceptions to parts 8830.5300 to 8830.5700 may be made for any particular contract if agreed to by all parties. An exception must not preclude the equal treatment of competing projects.

Statutory Authority: *MS s 218.071; 219.073; 219.165; 219.17; 219.384; 222.50; 222.58; 222.63*

History: 23 SR 524

8830.5690 REQUEST FOR INFORMATION.

The commissioner shall direct requests for information under the authority of Minnesota Statutes, section 222.54, to the corporate office of the rail carrier. The commissioner's requests will specify the kind of information, the level of detail needed, and the required date of submittal.

Within 20 days from the receipt of the request, the rail carrier, if necessary, may apply for a revision of the time schedule for preparing the information. The commissioner shall approve or disapprove the requests.

If the requested information is not received within the time schedule, the commissioner may make a final demand. The final demand must be in writing and sent by certified mail to the corporate office of the rail carrier. If the information is not received within 60 days of the receipt of the final demand, the commissioner may issue a subpoena to compel production of the information.

Statutory Authority: *MS s 218.071; 219.073; 219.165; 219.17; 219.384; 222.50; 222.58; 222.63*

History: 23 SR 524

8830.5700 DISCLOSURE OF RAIL CARRIER DATA.

Subpart 1. **Confidential information, defined.** Information is considered confidential for the purpose of this chapter when the information collected contains shipping, commercial, or financial data that is required to be kept confidential by United States Code, title 49, section 11910, as amended.

Subp. 2. [Renumbered 8830.5690]

8830.5700 RAILROADS

1296

Subp. 3. **Use of confidential data.** Rail carrier data entrusted to the commissioner will be used only by Mn/DOT personnel or the authorized agents of Mn/DOT to implement the purpose set forth in Minnesota Statutes, sections 222.46 to 222.54.

Subp. 4. **Release of information.** Information intended for the restricted use by the commissioner may be provided to persons outside Mn/DOT only in the following circumstances:

A. the rail carrier gives written approval to the commissioner to make the information public;

B. the information has already been made public by the action of the rail carrier or other public authority; or

C. the information is aggregated at a sufficient level to obscure the shipping, commercial, and financial information specific to an individual rail user.

Statutory Authority: *MS s 218.071; 219.073; 219.165; 219.17; 219.384; 222.50; 222.54; 222.58; 222.63*

History: 23 SR 524

8830.5800 Subpart 1. [Repealed, 23 SR 524]

Subp. 2. [Renumbered 8830.0100, subp. 13]

Subp. 3. [Repealed, 23 SR 524]

Subp. 4. [Repealed, 23 SR 524]

Subp. 5. [Repealed, 23 SR 524]

Subp. 6. [Repealed, 23 SR 524]

Subp. 7. [Repealed, 23 SR 524]

Subp. 8. [Renumbered 8830.0100, subp. 22]

Subp. 9. [Renumbered 8830.0100, subp. 41a]

Subp. 10. [Renumbered 8830.0100, subp. 42]

Subp. 11. [Repealed, 23 SR 524]

Subp. 12. [Repealed, 23 SR 524]

Subp. 13. [Repealed, 23 SR 524]

Subp. 14. [Repealed, 23 SR 524]

Subp. 15. [Renumbered 8830.0100, subp. 69]

RAIL BANK

8830.5810 PROGRAM CRITERIA.

Subpart 1. **Eligibility.** An abandoned rail line or right-of-way is eligible for acquisition and preservation in the state rail bank if it meets the requirements of Minnesota Statutes, section 222.63, subdivision 2b.

Subp. 2. **Criteria.** The commissioner will consider the following criteria in determining whether an abandoned rail line or right-of-way will be acquired:

A. the availability of program funds;

B. the probability of the rail line being utilized for the purpose identified;

C. the likelihood that an alternative rail line right-of-way could not be reestablished in the future;

D. the likelihood that no other entity will acquire the rail line for an appropriate use; and

E. the adequacy of the title and the costs to cure defects in the title.

Subp. 3. [Repealed, 23 SR 524]

Subp. 4. [Repealed, 23 SR 524]

Statutory Authority: *MS s 218.071; 219.073; 219.165; 219.17; 219.384; 222.50; 222.58; 222.63*

History: *23 SR 524*

8830.5820 ACQUIRING RAIL BANK PROPERTY.

Subpart 1. **Notice to acquire rail bank property.** The commissioner shall publish notice in the State Register listing the rail lines and rights-of-way proposed to be acquired. The notice must also be published once a week for two consecutive weeks in at least one newspaper of general circulation in each county where the property included in the list is located.

The published notice must include the following information:

- A. a statement that the notice is published pursuant to Minnesota Statutes, section 222.63, subdivision 3;
- B. the identifying name and owner of each rail line;
- C. the length in miles (kilometers) and the estimated acreage (hectares) of the property proposed for acquisition;
- D. the counties where the property is located;
- E. the abandonment status of each rail line;
- F. the name, address, and telephone number of Mn/DOT's contact person; and
- G. the proposed use and the conditions under which the property would be utilized.

Subp. 2. **Beginning title search.** A title search of the property proposed for acquisition must be started after the procedures under subpart 1 have been completed. For a rail line not yet abandoned, a title search must be started after the owning rail carrier has filed an abandonment application with the Surface Transportation Board under United States Code, title 49, section 10904, as amended. To inform the public of a title search of the property proposed for acquisition, the commissioner shall publish a notice in the State Register and at least one newspaper of general circulation in each county where the property is located.

Subp. 3. **Public information meeting.** After the title search has been completed, the commissioner shall hold at least one public meeting to provide information and to seek comments from the public. Notice of the meeting must be published in the State Register and in at least one newspaper of general circulation for two consecutive weeks in each county where the property is located. The meeting must be held no fewer than three days after publication of the second notice. At least one meeting must be held in each county where the property is located.

The published notice must include the information under subpart 1.

Subp. 4. **Decision to acquire.** The commissioner shall decide whether or not to acquire a rail line and right-of-way after the public information meeting. The decision must be based upon the program criteria cited in part 8830.5810. The commissioner shall publish notice of the decision in the State Register and in at least one newspaper of general circulation in each county where the property is located.

Subp. 5. **Notification to rail carrier.** The commissioner shall send a notice to each rail carrier that owns property proposed for acquisition at the following times:

- A. when the initial and subsequent lists of proposed acquisitions are published under subpart 1;
- B. when the public meeting notices are published under subpart 3; and
- C. when the commissioner publishes notice of the decision under subpart 4.

8830.5820 RAILROADS

1298

Subp. 6. **Simultaneous implementation.** When possible, the commissioner shall simultaneously implement the procedures of parts 8830.5820 to 8830.5840 to acquire, utilize, or dispose of rail bank property. The initial notices published in the State Register and newspapers must include a statement noting which procedures are being implemented simultaneously.

Statutory Authority: *MS s 218.071; 219.073; 219.165; 219.17; 219.384; 222.50; 222.58; 222.63*

History: *23 SR 524*

8830.5830 UTILIZING RAIL BANK PROPERTY.

Subpart 1. **Notice to utilize rail bank property.** The commissioner shall publish notice in the State Register when the commissioner is considering utilizing rail bank property. The notice must also be published once a week for two consecutive weeks in at least one newspaper of general circulation in each county where the property is located. The published notice must include the information under part 8830.5820, subpart 1.

Subp. 2. **Public information meeting.** After the procedures under subpart 1 have been completed, the commissioner shall hold at least one public meeting to provide information on the proposal for utilization and to seek comments from the public. Notice of the meeting must be published in at least one newspaper of general circulation for two consecutive weeks in each county where the property is located. The meeting must be held no fewer than three days after publication of the second notice. At least one meeting must be held in each county where the property is located.

Subp. 3. **Decision to utilize.** The commissioner shall decide based on the criteria in part 8830.5810, subpart 2, whether or not to utilize the property as proposed after the public information meeting. The commissioner shall publish notice of the decision in at least one newspaper of general circulation in each county where the property is located.

Statutory Authority: *MS s 218.071; 219.073; 219.165; 219.17; 219.384; 222.50; 222.58; 222.63*

History: *23 SR 524*

8830.5840 DISPOSING OF RAIL BANK PROPERTY.

Subpart 1. **Notice to dispose of rail bank property.** The commissioner shall publish notice in the State Register when considering disposing of rail bank property under Minnesota Statutes, section 222.63, subdivision 4. The notice must also be published once a week for two consecutive weeks in at least one newspaper of general circulation in each county where the property is located. The notice must include the information under part 8830.5820, subpart 1, items A to G, and the reasons for and conditions of the disposal.

Subp. 2. **Public information meeting.** After the procedures under subpart 1 have been completed, the commissioner shall conduct at least one public meeting to provide information on the proposed disposition and to seek comments from the public. Notice of the meeting must be published in at least one newspaper of general circulation for two consecutive weeks in each county where the property is located. The meeting must be held no fewer than three days after publication of the second notice. At least one meeting must be held in each county where the property is located.

Subp. 3. **Decision to dispose of property.** The commissioner shall decide whether or not to dispose of property after the public information meeting based on the criteria in part 8830.5810, subpart 2. The commissioner shall publish notice of the decision in at least one newspaper of general circulation in each county where the property is located.

Statutory Authority: *MS s 218.071; 219.073; 219.165; 219.17; 219.384; 222.50; 222.58; 222.63*

History: *23 SR 524*

8830.5850 MANAGEMENT OF RAIL BANK PROPERTY.

Subpart 1. **Maintenance or other use during preservation of property.** Rail bank property must be maintained and may be leased for other uses while it is being preserved in the state rail bank. The commissioner shall allow a proposed other use for rail bank property if it meets one or more of the following conditions:

- A. it was a use in effect before the commissioner acquired the property and the use will not interfere with utilization of property;
- B. the use will minimize maintenance costs and maximize income to the program;
- C. the use is not in conflict with uses of adjacent lands; or
- D. the use will provide a benefit to the state.

Subp. 2. **Other use during utilization of property.** The commissioner shall allow other uses that were in effect while the property was being preserved to continue while the property is being utilized for the purposes of the state rail bank program if the other uses do not interfere with the utilization of the property.

The commissioner shall allow a proposed other use that was not in effect before utilization if it does not interfere with utilization of the property and it meets one or more of the following conditions:

- A. the use will minimize maintenance costs and maximize income to the program;
- B. the use is not in conflict with uses of adjacent lands; or
- C. the use will provide a benefit to the state.

Statutory Authority: *MS s 218.071; 219.073; 219.165; 219.17; 219.384; 222.50; 222.58; 222.63*

History: *23 SR 524*

8830.5860 ADMINISTERING STATE RAIL BANK PROGRAM; VARIANCES.

Subpart 1. **Information for project or other use.** The entity proposing a utilization project or other use of rail property shall provide the commissioner with pertinent information necessary to achieve proper evaluation and adequate administration of a project or other use. The information must include financial, commodity, cost and operations data, and other similar types of data and information.

Subp. 2. **Contracts.** Executed written contracts must be the documents used to commit funds, to implement utilization projects, and to authorize other uses of rail bank property.

Subp. 3. **Variance.** The commissioner may approve a written request for a variance from parts 8830.5810 to 8830.5860. A variance will be granted if:

- A. the purpose of the rule in question can be accomplished or exceeded by the specific alternate practice proposed for substitution;
- B. the application of the rule in question would impose an excessive burden on the person or entity applying for the variance in its attempt to carry out the intent of the rail bank program; and
- C. the granting of the variance will not adversely affect the public health and safety.

The commissioner shall set forth in writing the reasons for approving or denying a variance. The entity who is granted a variance shall comply with the alternative practice approved by the commissioner. The person or entity who is granted a variance shall immediately notify the commissioner of any material change in the circumstances that justified granting the variance.

8830.5860 RAILROADS

1300

A variance may be revoked if changes occur in the circumstances that justified the variance, or if the entity granted the variance fails to comply with the alternative practice approved by the commissioner.

Statutory Authority: *MS s 218.071; 219.073; 219.165; 219.17; 219.384; 222.50; 222.58; 222.63*

History: *23 SR 524*

8830.6100 Subpart 1. [Repealed, 23 SR 524]

Subp. 2. [Repealed, 23 SR 524]

Subp. 3. [Repealed, 23 SR 524]

Subp. 4. [Renumbered 8830.0100, subp. 17]

Subp. 5. [Repealed, 23 SR 524]

Subp. 6. [Repealed, 23 SR 524]

Subp. 7. [Repealed, 23 SR 524]

Subp. 8. [Repealed, 23 SR 524]

Subp. 9. [Repealed, 23 SR 524]

Subp. 10. [Repealed, 23 SR 524]

Subp. 11. [Renumbered 8830.0100, subp. 35]

Subp. 12. [Repealed, 23 SR 524]

Subp. 13. [Repealed, 23 SR 524]

Subp. 14. [Repealed, 23 SR 524]

Subp. 15. [Repealed, 23 SR 524]

Subp. 16. [Repealed, 23 SR 524]

Subp. 17. [Repealed, 23 SR 524]

8830.6200 [Repealed, 23 SR 524]

**RAIL USER AND RAIL CARRIER
LOAN GUARANTEE**

8830.6300 APPLICATION FOR BANK LOAN.

All information required to be submitted to the commissioner under this chapter to support consideration for acceptance as an insured loan must be submitted in duplicate, and include:

A. a written statement under oath executed by the borrower that the proceeds of the loan will be used solely for participation in contracts for the purposes set forth in Minnesota Statutes, section 222.58, subdivision 2, paragraph (b);

B. a copy of the contract, containing: the identification of the participating parties; the total amount of the contract; the respective share of the amount of the contract to be provided by each participating party; the conditions for repayment of the total amount of the contract to the participating parties; the subject matter of the contract; and the identity of the escrow agent, if any;

C. the loan application taken by the lender, together with all supporting documents and data, pertinent to the lender's credit consideration, including:

(1) the principal amount of the loan and repayment terms;

(2) the collateral offered;

(3) the investigative credit data developed;

(4) the borrower's statement of present financial condition, including schedule of assets, liabilities, capital or net worth, and income and expenses, and statements for the immediately preceding three fiscal years; and

(5) the application of the person or corporation, if any, making a guarantee of the loan together with its statement of financial condition as required in subitem (4);

D. the form of the promissory note to be executed, complete except for signatures, and any guarantee forms to be executed;

E. the form of the security agreements or mortgages to be executed in connection with the loan, complete except for signatures, including the complete legal description of the property, personal or real, to be pledged, supplemented in addition by:

(1) a statement of the collateral's condition, marketability, and appraised value, including the source of the appraisal;

(2) a statement of priority of a lien or security interest position based on an official records search; and

(3) evidence of insurance coverage against customary perils and the availability of suitable loss payable assignments;

F. a lender's sworn statement to the commissioner that includes:

(1) the citation of Minnesota Statutes under which the interest rate and other expenses in connection with the loan are deemed lawful; and

(2) documentation of the lender's appraisal and consent to make the loan in the amount applied for, which may be conditioned upon the granting of the commitment for insurance by the commissioner;

G. an executed agreement between the lender and borrower that upon granting of the commitment for insurance by the commissioner that:

(1) funds will be disbursed only under the terms and for the purposes set forth in the application for insurance;

(2) liens and security interests provided for in the application and documents offered in the application for insurance will be filed, recorded, or otherwise perfected by the lender;

(3) the lender or its agents shall exercise reasonable care to protect the interest of the state;

(4) a copy of the notice of default required by Minnesota Statutes, section 222.58, subdivision 4, to be sent to the borrower within 90 days of default of the loan, must also be sent to any person or corporation guaranteeing the loan; and

(5) if default is continued for 180 days and the borrower has not made arrangements to meet the obligation, the lender shall promptly notify the commissioner of the circumstances of default and file a claim for benefits under Minnesota Statutes, section 222.58, subdivision 4.

Statutory Authority: *MS s 218.071; 219.073; 219.165; 219.17; 219.384; 222.50; 222.58; 222.61; 222.63*

History: *17 SR 1279; 23 SR 524*

8830.6400 APPLICATION FOR LOAN GIVEN BY PUBLIC AUTHORITY.

All information required to be submitted to the commissioner for consideration for commitment to insure any eligible loan must be submitted in duplicate, and include:

A. the information required by part 8830.6300, items A to F and G, subitem (3);

B. a copy of the application for the revenue bond project together with any attachments required to be submitted to the Minnesota Department of Commerce;

C. evidence of the approval of the application for the revenue bond project by the Department of Commerce;

D. a statement that upon granting of the commitment for insurance by the commissioner that a copy of the notice of default required by Minnesota Statutes, section 222.58, subdivision 5, to be sent to the borrower within 15 days of the default of the terms of the

8830.6400 RAILROADS

1302

revenue agreement, must also be sent to any person or corporation guaranteeing the agreement; and

E. a statement that after 90 days, if default continues, a claim must be filed with the commissioner stating the nature of the default.

Statutory Authority: *MS s 218.071; 219.073; 219.165; 219.17; 219.384; 222.50; 222.58; 222.61; 222.63*

History: *23 SR 524*

8830.6500 ELIGIBILITY REQUIREMENTS FOR BANK LOAN.

Subpart 1. **Principal amount.** The original bona fide principal amount of any loan must not exceed:

A. an amount that can be shown to be fully secured by the equity determined by the current appraised value of the collateral to be pledged by or on behalf of the borrower;

B. an amount that can be reasonably documented and shown to be secured by the value found in the guarantee up to a maximum proportion of 40 percent of the original bona fide principal with the remaining proportion to be fully secured in the manner prescribed in item A.

Subp. 2. **Interest rate.** The interest rate agreed upon between the borrower and the lender must be expressed clearly in the loan agreement in annual percentage rate terms and include the manner in which lapsed periods of time are to be calculated for purposes of application of that rate, if interest is to be calculated or collected in intervals of less than one calendar year.

Subp. 3. **Repayment terms.** The commissioner shall grant the approval called for by this part if the loan agreement remains substantially the same, the loan agreement is in accordance with parts 8830.6300 to 8830.6700, and the risks to the state by the change in the agreement are fully protected. The loan agreement must provide for repayment terms that:

A. include a schedule of installment payments of principal and interest that will extinguish the original bona fide principal of the loan over a term not exceeding ten years from the date of execution of the loan;

B. include a schedule of periodic installment payments of principal and interest coming due at least each three months or such lesser intervals as are reasonably consistent with the revenue income flow determined to support the ability on the part of the borrower to repay the obligation;

C. provide that the first installment of principal and interest may be scheduled so as to coincide with the first anticipated revenue;

D. include language that provides that no refinancing, extension, or deferment of the originally contracted obligation as approved for insurance or its security, or otherwise as would operate to modify the original contract terms may be made between the borrower and the lender unless those considerations are in writing and expressly approved by the commissioner; and

E. include language that effectively renders the obligation as documented to be nontransferable as to all or any part of its interests without prior written approval of the commissioner.

Subp. 4. **Deferment.** No loan agreement may be the subject of any extension of time or deferment of originally scheduled installment payments that would result in the final contracted payment of principal or interest, or combination of principal and interest, to fall

due at a date more than ten years from the date of origin, without prior written approval of the commissioner.

Statutory Authority: *MS s 218.071; 219.073; 219.165; 219.17; 219.384; 222.50; 222.58; 222.63*

History: *23 SR 524*

8830.6600 ELIGIBILITY REQUIREMENTS FOR PUBLIC AUTHORITY LOAN.

Subpart 1. **Principal amount.** The original bona fide principal amount as to the amount insured of any revenue agreement, exclusive of interest and expense, must not exceed:

A. an amount that can be shown to be fully secured by the equity determined by the current appraised value of the collateral to be pledged by or on behalf of the borrower; or

B. an amount that can be reasonably documented and shown to be secured by the value found in the guarantee up to a maximum proportion of 40 percent of the original bona fide principal with the remaining proportion to be fully secured in the manner prescribed in item A.

Subp. 2. **Repayment of revenue agreement.** The repayment of the revenue agreement must be such that it will produce income and revenue sufficient to provide for the repayment, when due, of principal and interest on all bonds issued under the agreement.

Subp. 3. **Repayment terms.** The revenue agreement must provide for:

A. repayment terms, including a schedule of installment payments of principal and interest, that will extinguish the original bona fide principal of the bonds over a period not to exceed ten years from the date of origin;

B. language that provides that no revision of the revenue agreement may be made between the borrower and the lender unless the revisions are approved by the commissioner; and

C. language that would effectively render the revenue agreement nontransferable as to all or any part of its interest without the expressed approval of the commissioner.

Subp. 4. **Granting approval.** The commissioner shall grant the approvals called for by this part if the loan agreement remains substantially the same, the loan agreement is in accordance with parts 8830.6300 to 8830.6700, and the risks to the state by the change in the agreement are not increased and the interests of the state are fully protected.

Statutory Authority: *MS s 218.071; 219.073; 219.165; 219.17; 219.384; 222.50; 222.58; 222.63*

History: *23 SR 524*

8830.6700 INTEREST ADJUSTMENT.

Subpart 1. **Eligibility requirements.** In order to be eligible for an interest adjustment, an applicant must meet the requirements of Minnesota Statutes, section 222.58, subdivision 5a.

Subp. 2. **Repayment procedures.** The borrower shall reimburse the commissioner for any amounts paid as an interest adjustment within one year after the final payment to a lending institution is due on the loan. The reimbursement to the commissioner may be made in equal installments over the period of one year or in a single payment at the close of that year.

If the borrower has no proprietary right in the property to be rehabilitated, then a promissory note must be negotiated between the borrower and the commissioner prior to the granting of a loan guarantee to insure repayment of the interest adjustment.

Statutory Authority: *MS s 218.071; 219.073; 219.165; 219.17; 219.384; 222.50; 222.58; 222.63*

History: *23 SR 524*

8830.9900 [Repealed, 23 SR 524]

EXHIBITS, FIGURES, TABLES

8830.9901 SIGNS, ACTIVE WARNING DEVICES, AND LOCATIONS.

Subpart 1. Crossbuck sign.

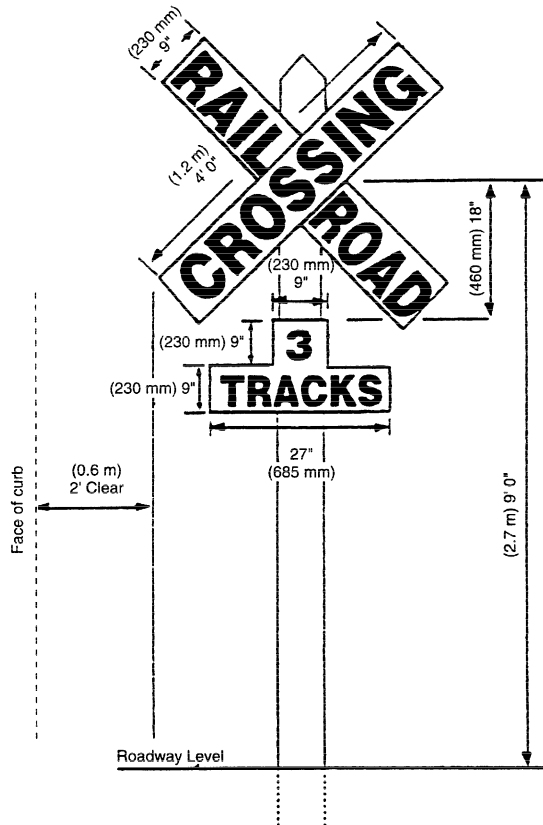

Crossbuck Sign: Black letters on reflectorized white background

Multiple Track Sign: Black letters on reflectorized white background, to be used when sign assembly warns of more than one track.

Height may vary as required by local conditions.

Post must meet the breakaway criteria of AASHTO's "Standard Specifications for Structural Supports for Highway Signs, Luminaries and Traffic Signals".

Crossbuck assembly to be located in compliance with the MMUTCD.

Subp. 2. Stop sign at grade crossing.

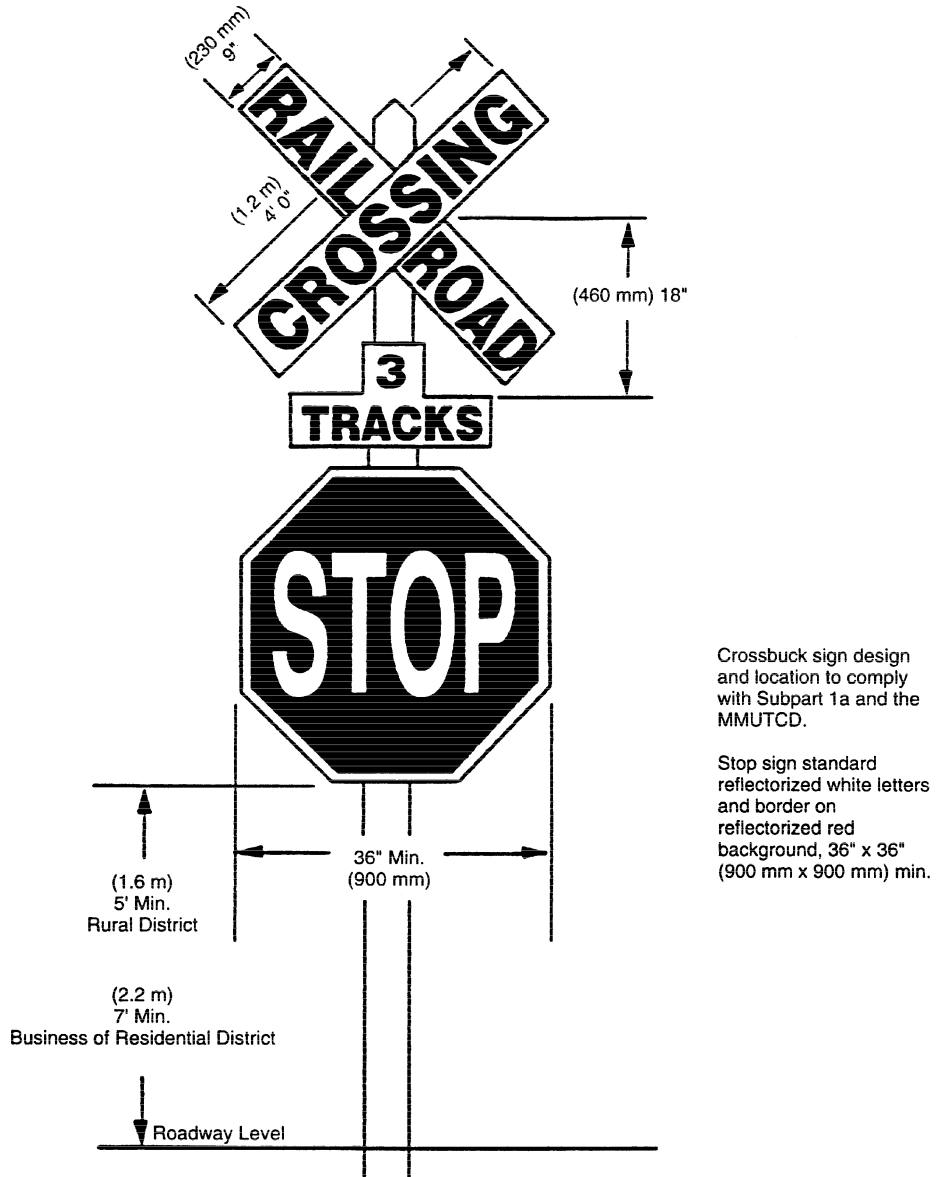

Subp. 3. Grade crossing active warning device.

Typical clearance plan showing two feet (0.6 meters) minimum clearance from the curb. Signals are to be located in compliance with the MMUTCD.

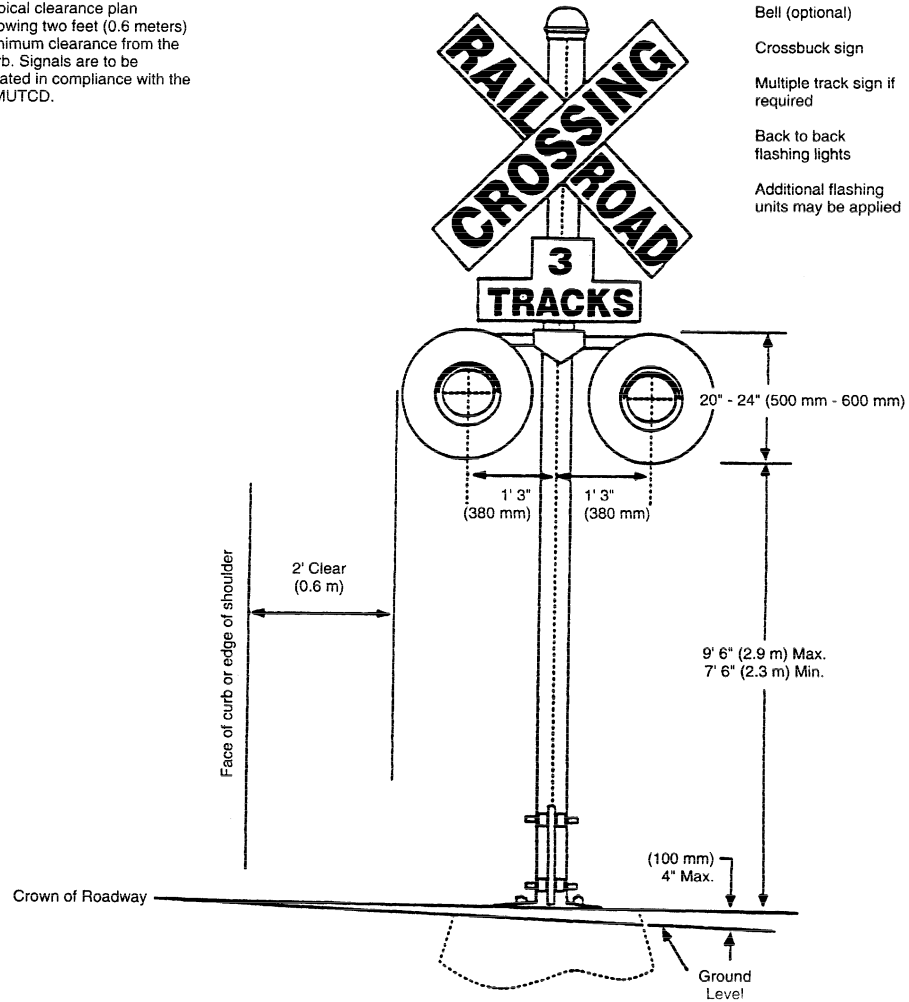

Subp. 4. Grade crossing active warning device; cantilever type.

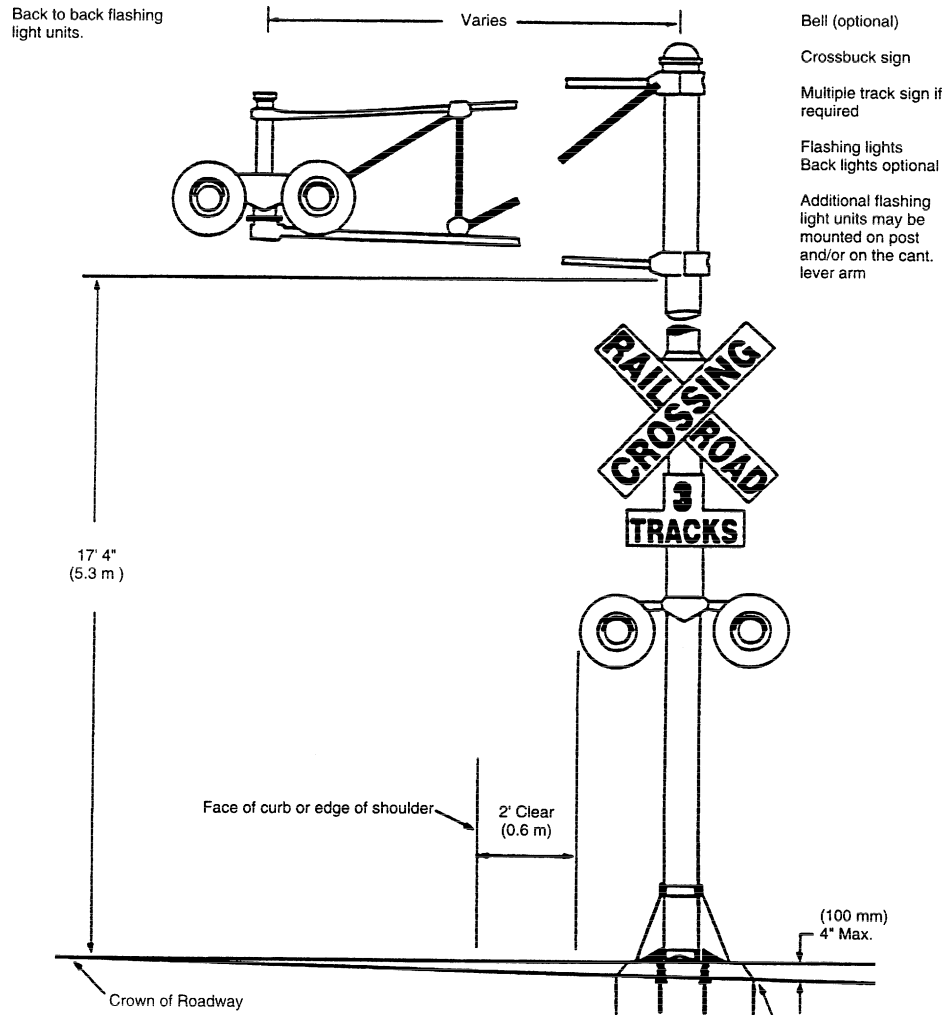

Subp. 5. Grade crossing active warning device with gate.

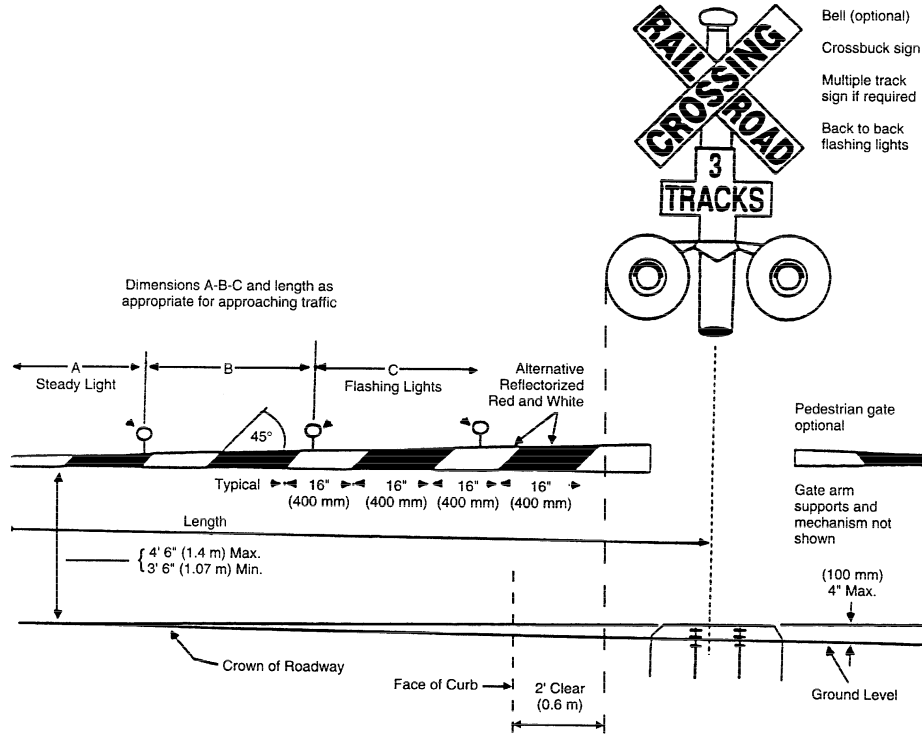

Subp. 6. Typical location for grade crossing active warning device.

Typical clearance plan showing two feet (0.6 meter) minimum clearance from curb. Signals are to be located in compliance with the MMUTCD.

Where gates are located in the median, additional clearance may be required for the counterweight supports.

Where there is no curb, a minimum horizontal clearance of two feet from edge of shoulder shall be provided. Where there is no curb or shoulder, the minimum horizontal clearance of six feet (1.8 meters) from edge of traveled way shall be maintained.

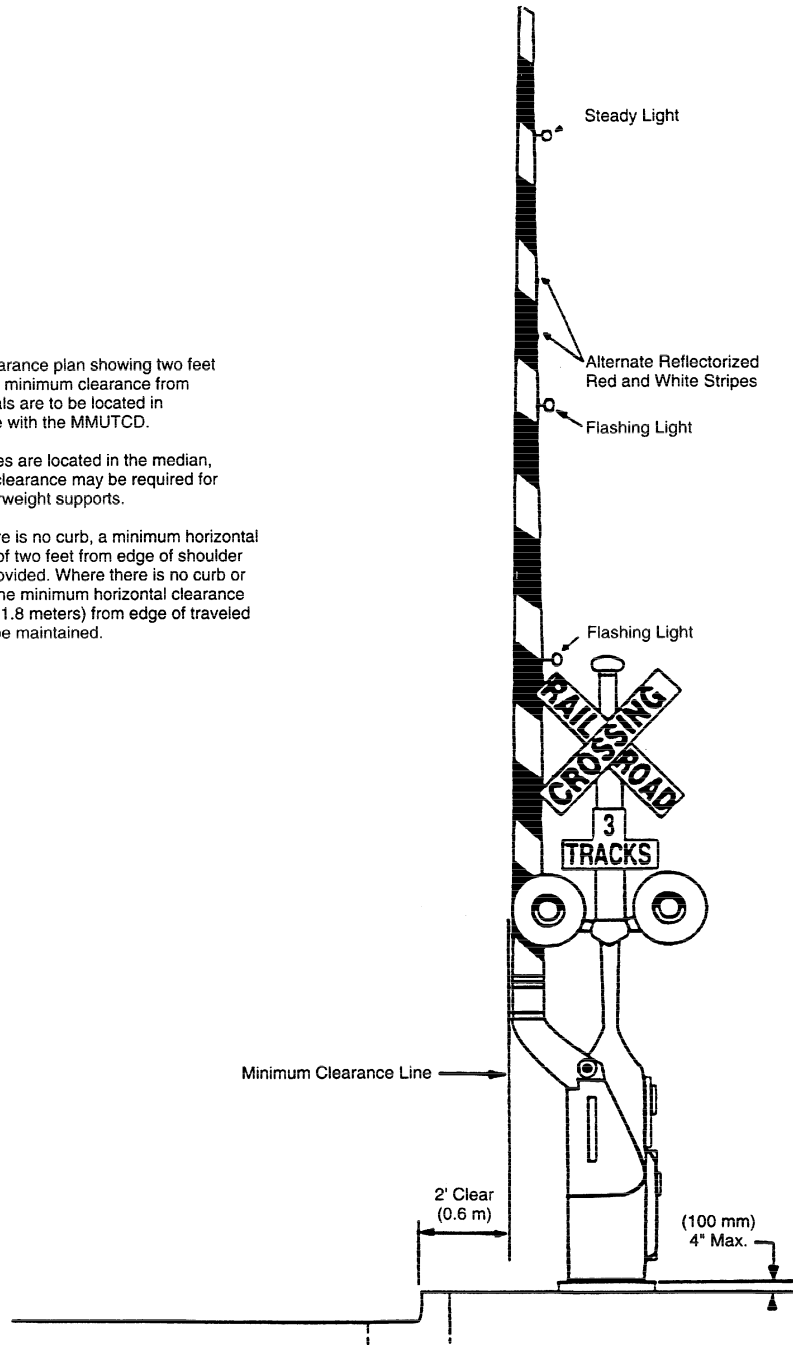

Subp. 7. Standard grade crossing active warning device location.

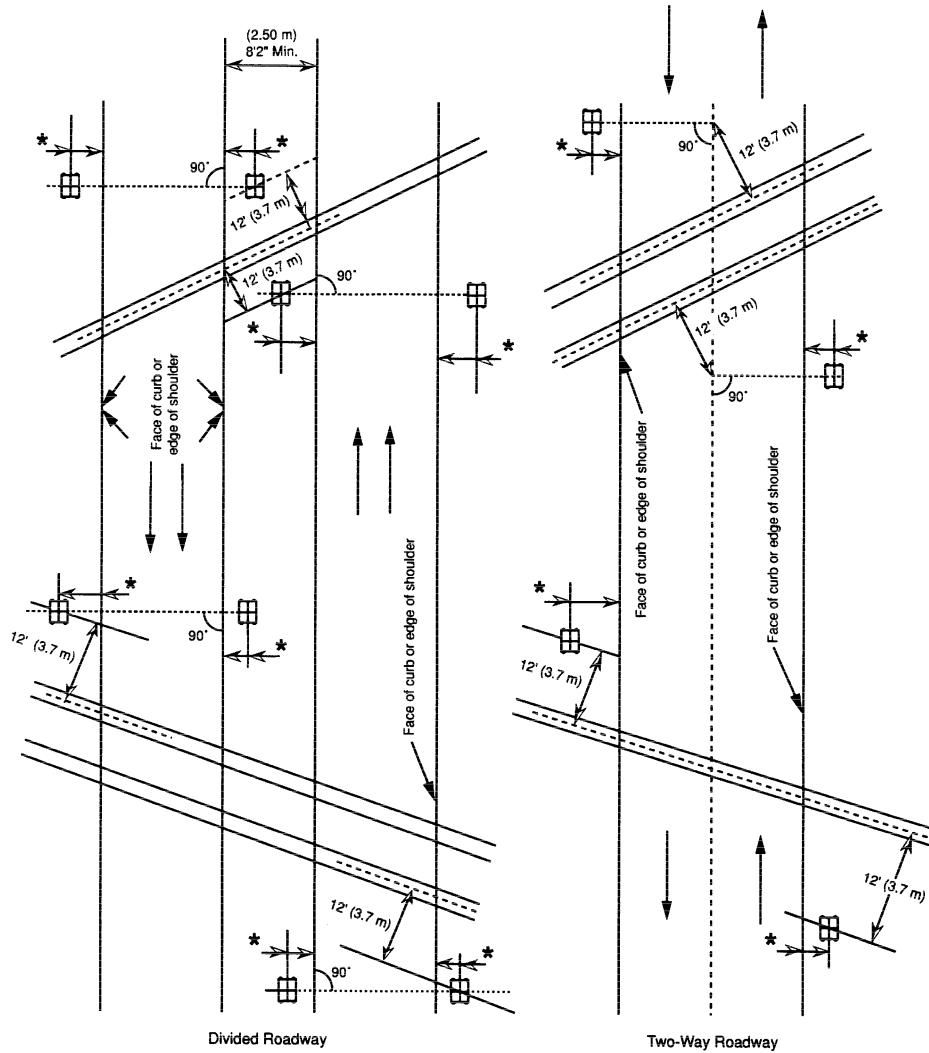

* 4'1" (1.25 m) to 4'3" (1.3 m)

Statutory Authority: *MS s 218.071; 219.073; 219.165; 219.17; 219.384; 222.50; 222.58; 222.63*

History: 23 SR 524

8830.9910 [Repealed, 23 SR 524]

8830.9911 CROSSBUCK AND AUXILIARY SIGN.

Subpart 1. Crossbuck sign.



R15-1
White background

Subp. 2. Auxiliary sign.



R15-2
White background

Statutory Authority: *MS s 218.071; 219.073; 219.165; 219.17; 219.384; 222.50; 222.58; 222.63*

History: *23 SR 524*

8830.9920 [Repealed, 23 SR 524]

8830.9921 ADVANCE-WARNING SIGNS.

Subpart 1. **Advance-warning sign W10-1.**



W10-1
Yellow background

Subp. 2. **Advance-warning sign W10-2.**

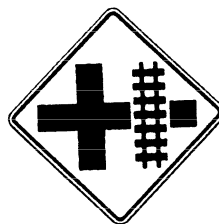

W10-2
Yellow background

8830.9921 RAILROADS

1312

Subp. 3. Advance-warning sign W10-3.

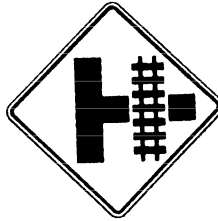

W10-3
Yellow background

Subp. 4. Advance-warning sign W10-4.

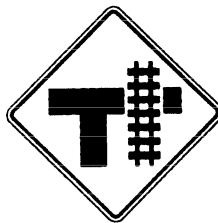

W10-4
Yellow background

Statutory Authority: *MS s 218.071; 219.073; 219.165; 219.17; 219.384; 222.50; 222.58; 222.63*

History: 23 SR 524

8830.9930 [Repealed, 23 SR 524]

8830.9931 SUPPLEMENTARY ADVANCE-WARNING SIGNS.

Subpart 1. "Track-angle" sign.

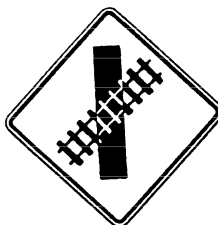

W10-X1
Yellow background

Subp. 2. "Blind-crossing" sign.

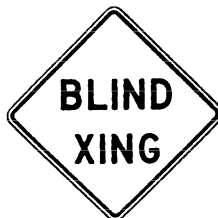

MINNESOTA RULES 2013

1313

RAILROADS 8830.9941

W10-X2
Yellow background

Subp. 3. "Look for trains" sign.



W10-X3
Yellow background

Statutory Authority: *MS s 218.071; 219.073; 219.165; 219.17; 219.384; 222.50; 222.58; 222.63*

History: *23 SR 524*

8830.9940 [Repealed, 23 SR 524]

8830.9941 OTHER REGULATORY SIGNS.

Subpart 1. "Exempt-crossing" sign.



R15-3 White background
W10-1a Yellow background

Subp. 2. "Stop ahead" sign.



W3-1a
Yellow background

Subp. 3. "Do not stop on tracks" sign.



R8-8
White background

8830.9941 RAILROADS

1314

Subp. 4. "Tracks out of service" sign.



R8-9
White background

Subp. 5. "No turn on red" sign.



R10-11a
White background

Statutory Authority: *MS s 218.071; 219.073; 219.165; 219.17; 219.384; 222.50; 222.58; 222.63*

History: 23 SR 524

8830.9950 [Repealed, 23 SR 524]

MINNESOTA RULES 2013

1315

RAILROADS 8830.9951

8830.9951 CLEARANCES.

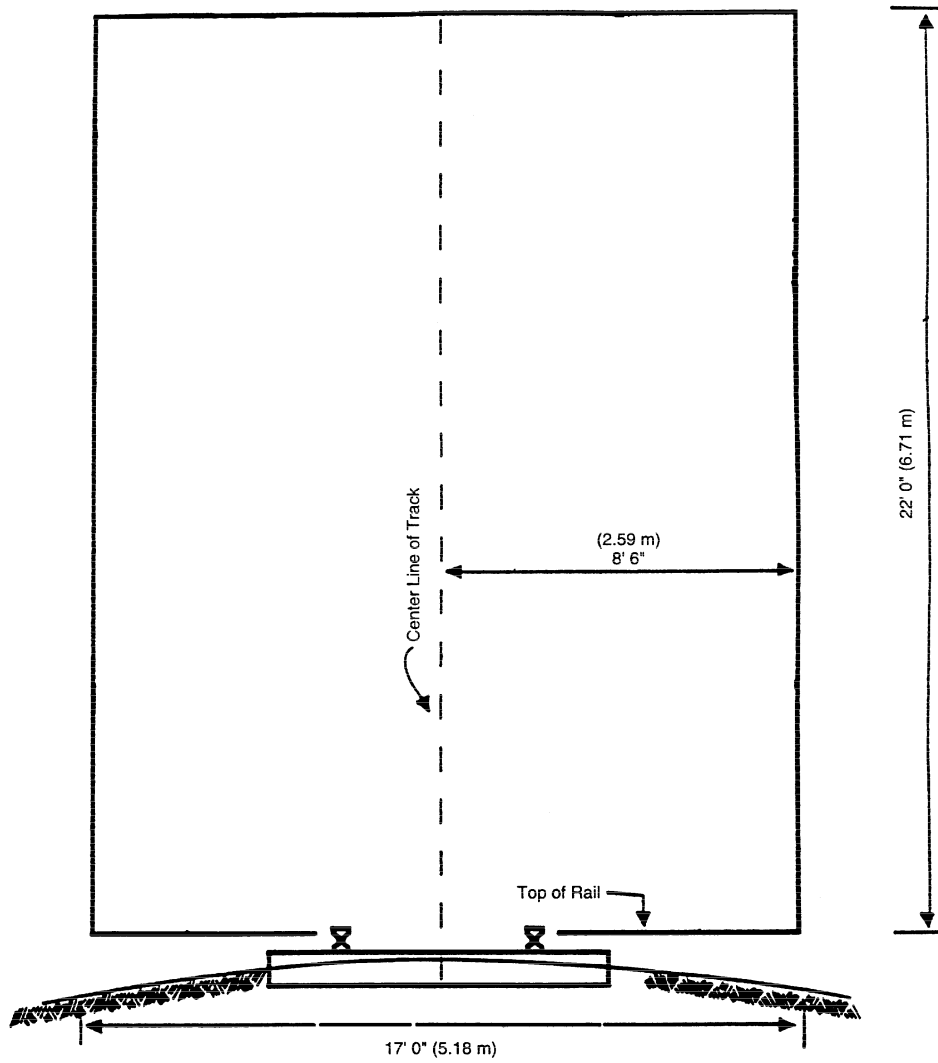

Statutory Authority: *MS s 218.071; 219.073; 219.165; 219.17; 219.384; 222.50; 222.58; 222.63*

History: *23 SR 524*

8830.9961 STANDARD "NO CLEARANCE" SIGN.

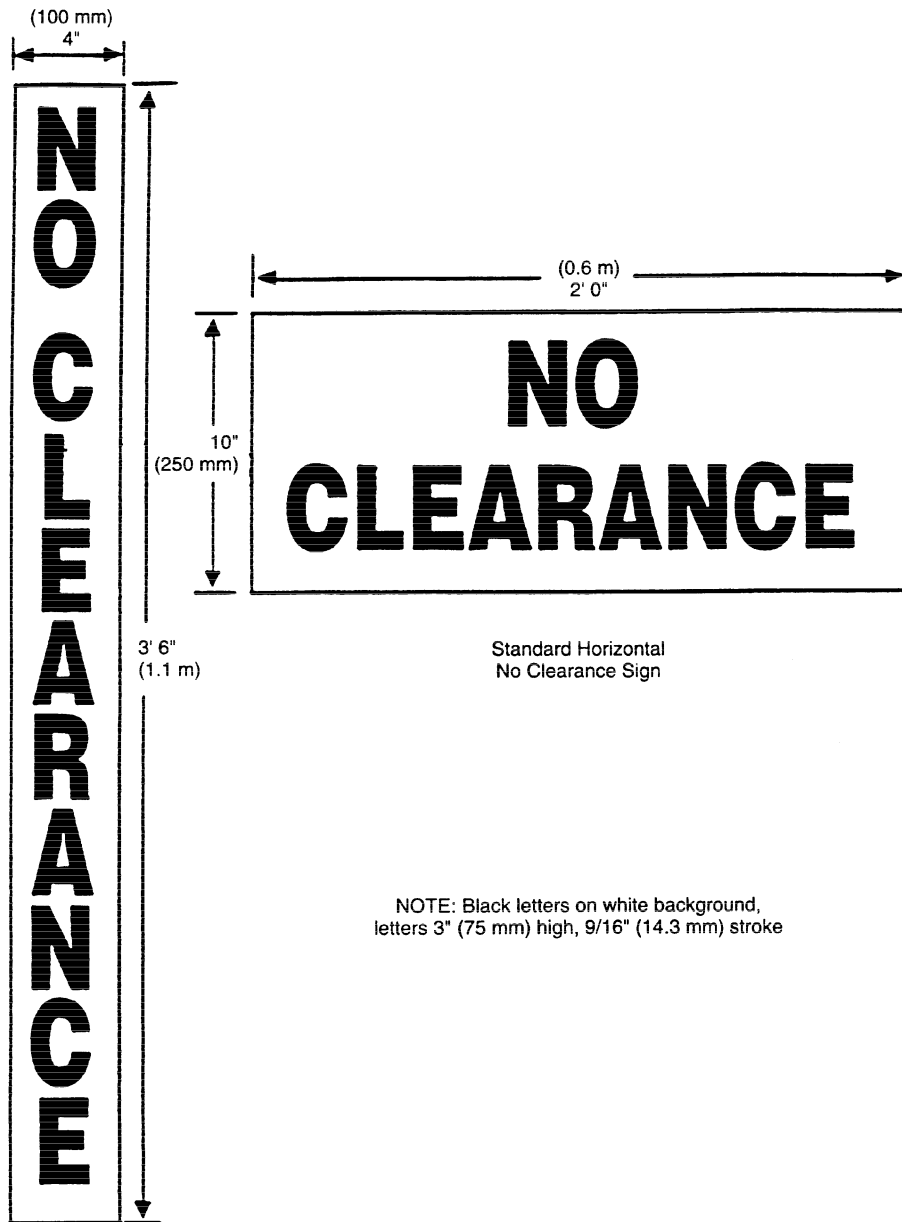

Standard Horizontal
No Clearance Sign

NOTE: Black letters on white background,
letters 3" (75 mm) high, 9/16" (14.3 mm) stroke

Statutory Authority: *MS s 218.071; 219.073; 219.165; 219.17; 219.384; 222.50; 222.58; 222.63*

History: 23 SR 524

MINNESOTA RULES 2013

1317

RAILROADS 8830.9971

8830.9971 WARNING SIGN FOR TRAIN CREW MEMBERS.

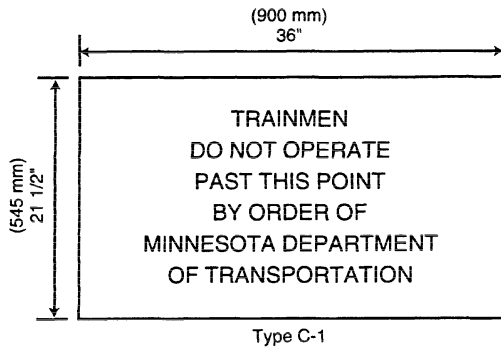

Warning Signs:
Black letters, 1-1/2" (40 mm and 2" (50 mm) with 1/4" (6 mm) stroke, on white background

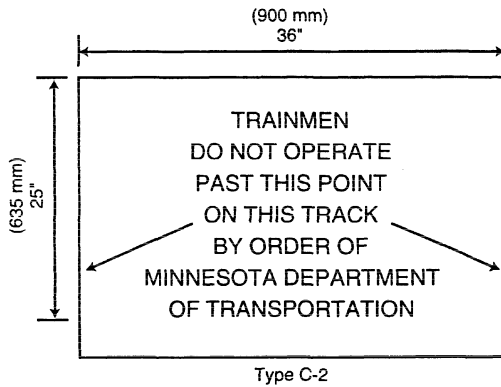

Note: Arrow to be placed on left or right side of the sign depending on track involved.

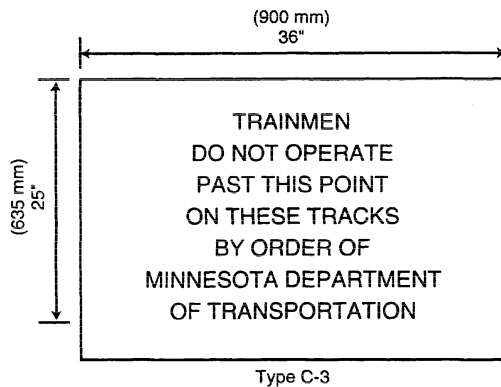

Warning signs to be placed at point along tracks beyond which trainmen are not to operate. No such sign shall be placed at any such point along side or over any track without the authority of the Minnesota Department of Transportation.

Statutory Authority: *MS s 218.071; 219.073; 219.165; 219.17; 219.384; 222.50; 222.58; 222.63*

History: 23 SR 524

MINNESOTA RULES 2013

8830.9991 RAILROADS

1318

8830.9991 OPERATING LICENSE.

Authorized Signal System: <input type="checkbox"/> 12" Lenses <input type="checkbox"/> Gates <input type="checkbox"/> Cantilevers <input type="checkbox"/> Flashing Lights <input type="checkbox"/> Motion Detectors <input type="checkbox"/> Speed Predictors <input type="checkbox"/> Reason for Issuance:	DEPARTMENT OF TRANSPORTATION STATE OF MINNESOTA <hr style="width: 50%; margin: auto;"/> (Street, route System) (City), Minnesota (County) (Railroad) <hr style="width: 50%; margin: auto;"/> OPERATING LICENSE RAILROAD CROSSING SIGNALS	USDOTNO: COMAPREF: - - Agreement: File: F- Number of Tracks: Plans Approved: In-Service Date: Inspection Date:
---	---	---

The warning signal system with its various parts and appliances, having been duly inspected and examined by the Department of Transportation of the State of Minnesota, as provided by law, and having been found sufficient for the purpose of such a signal system, a plan of which is filed in this office;

NOW, THEREFORE, the aforesaid signal system is hereby approved in manner and form as described and shown upon the plan approved now on file in the Office of the Department, and this license shall authorize the above mentioned Railway Company to operate the said signal system until further order of this Department, subject, however, to the following conditions, to-wit:

FIRST: That the aforesaid Railway Company shall not operate its trains over the crossing without providing a warning time for the railroad crossing signals as required by D.O.T. rules 8830.12 and 8830.13 and shall not operate its trains over the approach circuits of this signal system at a rate of speed in excess of:

MPH in either direction

SECOND: The aforesaid Railway Company shall cause said signal system to be inspected and maintained as required by 49 Code of Federal Regulations (CFR) Part 234.

THIRD: When notified of failure of the aforesaid warning signal system to function properly, the Railway Company shall respond as required by 49 Code of Federal Regulations (CFR) Part 234.

FOURTH: No change shall be made in said signal system, or any of its parts, nor in the manner of operating the same, without the approval of the Department.

FIFTH: The speed limit or limits established by this license relate only to the maximum permissible train speed in the vicinity of the grade crossing with its associated signal device circuitry which will provide adequate warning time to highway traffic. It does not preclude the establishment of more restrictive speed limits caused by track conditions or by any regulatory authority of a governmental unit.

STATE OF MINNESOTA
DEPARTMENT OF TRANSPORTATION

Dated in St. Paul, MN
(date)

Director, Railroad Administration

Statutory Authority: *MS s 218.071; 219.073; 219.165; 219.17; 219.384; 222.50; 222.58; 222.63*

History: *23 SR 524*