

CHAPTER 7080
MINNESOTA POLLUTION CONTROL AGENCY
WATER QUALITY DIVISION
INDIVIDUAL SEWAGE TREATMENT SYSTEMS
STANDARDS

7080.0010	PURPOSE AND INTENT.	7080.0120	BUILDING SEWERS.
7080.0020	DEFINITIONS.	7080.0130	SEWAGE TANKS.
7080.0030	ADMINISTRATION BY STATE AGENCIES.	7080.0150	DISTRIBUTION OF EFFLUENT.
7080.0040	ADMINISTRATION BY LOCAL UNITS OF GOVERNMENT.	7080.0160	DOSING OF EFFLUENT.
7080.0050	SURFACE DISCHARGE.	7080.0170	FINAL TREATMENT AND DISPOSAL.
7080.0060	TREATMENT REQUIRED.	7080.0180	ALTERNATIVE SYSTEMS.
7080.0070	SYSTEM COMPONENTS.	7080.0190	SEVERABILITY.
7080.0080	PROHIBITED INSTALLATIONS.	7080.0200	VARIANCE.
7080.0090	SYSTEM SIZING.	7080.0210	APPENDIX A: ALTERNATIVE SYSTEMS.
7080.0100	ADVISORY COMMITTEE.	7080.0220	APPENDIX C.
7080.0110	SITE EVALUATION.	7080.0230	APPENDIX D.
		7080.0240	APPENDIX E.

7080.0010 PURPOSE AND INTENT.

The improper design, location, installation, use, and maintenance of individual sewage treatment systems adversely affects the public health, safety, and general welfare by discharge of inadequately treated sewage to surface and ground waters. In accordance with the authority granted in Minnesota Statutes, chapters 104, 105, 115, and 116, the Minnesota Pollution Control Agency, hereinafter referred to as the agency, does hereby provide the minimum standards and criteria for the design, location, installation, use, and maintenance of individual sewage treatment systems, and thus protect the surface and ground waters of the state, and promote the public health and general welfare.

Further, it is intended that the administration and enforcement of these standards be conducted by local units of government, since experience has shown that sanitary ordinances can most effectively be administered at the local level.

Statutory Authority: *MS s 115.03 subd 1*

7080.0020 DEFINITIONS.

Subpart 1. **Certain terms.** For the purposes of these standards, certain terms or words used herein shall be interpreted as follows: the word "shall" is mandatory, the words "should" and "may" are permissive. All distances, unless otherwise specified, shall be measured horizontally.

Subp. 2. **Aerobic tank.** "Aerobic tank" means any sewage tank which utilizes the principle of oxidation in the decomposition of sewage by the introduction of air into the sewage.

Subp. 3. **Agency.** "Agency" means the Minnesota Pollution Control Agency.

Subp. 4. **Alternative system.** "Alternative system" means an individual sewage treatment system employing such methods and devices as presented in part 7080.0180.

Subp. 5. **Baffle.** "Baffle" means a device installed in a septic tank for proper operation of the tank and to provide maximum retention of solids, and includes vented sanitary tees and submerged pipes in addition to those devices that are normally called baffles.

Subp. 6. **Bedrock.** "Bedrock" means that layer of parent material which is consolidated and unweathered.

MINNESOTA RULES 1983

5691

INDIVIDUAL SEWAGE TREATMENT SYSTEMS 7080.0020

Subp. 7. **Bedroom.** "Bedroom" means any room within a dwelling that might reasonably be used as a sleeping room.

Subp. 8. **Building drain.** "Building drain" means that part of the lowest piping of the drainage system which receives the sewage discharge inside the walls of the building and conveys it to the building sewer beginning at least one foot outside the building footings.

Subp. 9. **Building sewer.** "Building sewer" means that part of the drainage system which extends from the end of the building drain and conveys its discharge to an individual sewage treatment system.

Subp. 10. **Capacity.** "Capacity" means the liquid volume of a sewage tank using inside dimensions below the outlet.

Subp. 11. **Cesspool.** "Cesspool" means an underground pit into which raw household sewage or other untreated liquid waste is discharged and from which the liquid seeps into the surrounding soil. See part 7080.0080.

Subp. 12. **DNR.** "DNR" means the Minnesota Department of Natural Resources.

Subp. 13. **Distribution pipes.** "Distribution pipes" means perforated pipes or agricultural drain tiles that are used to distribute sewage tank effluent in a soil treatment system.

Subp. 14. **Dosing chamber, or pump pit, or wet well.** "Dosing chamber, or pump pit, or wet well" means a tank or separate compartment following the sewage tank which serves as a reservoir for the dosing device.

Subp. 15. **Dosing device.** "Dosing device" means a pump, siphon, or other device that discharges sewage tank effluent from the dosing chamber to the soil treatment system.

Subp. 16. **Dwelling.** "Dwelling" means any building or place used or intended to be used by human occupants as a single family or two family unit.

Subp. 17. **Filter material.** "Filter material" means clean rock, crushed igneous rock, or similar insoluble, durable, and decay-resistant material free from dust, sand, silt, or clay. The size shall range from three-fourths inch to 2-1/2 inches.

Subp. 18. **Greywater.** "Greywater" means liquid waste from a dwelling or other establishment produced by bathing, laundry, culinary operations, and from floor drains, and specifically excluding toilet waste.

Subp. 19. **Holding tank.** "Holding tank" means a watertight tank for storage of sewage until it can be transported to a point of approved treatment and disposal.

Subp. 20. **Impermeable.** "Impermeable," with regard to bedrock, a bedrock having no cracks or crevices and having a vertical permeability less than one inch in 24 hours shall be considered impermeable. With regard to soils, a soil horizon or layer having a vertical permeability less than one inch in 24 hours shall be considered impermeable.

Subp. 21. **Individual sewage treatment system.** "Individual sewage treatment system" means a sewage treatment system, or part thereof, serving a dwelling, or other establishment, or group thereof, which utilizes subsurface soil treatment and disposal.

Subp. 22. **Local unit of government.** "Local unit of government" means a township, city, or county organized under the laws of the state of Minnesota.

Subp. 23. **Mottling.** "Mottling" means a zone of chemical oxidation and reduction activity, appearing as splotchy patches of red, brown, orange, and gray in the soil.

Subp. 24. **Mound system.** "Mound system" means a system where the soil treatment area is built above the ground to overcome limits imposed by proximity to water table or bedrock, or by rapidly or slowly permeable soils.

Subp. 25. **Other establishment.** "Other establishment" means any public or private structure other than a dwelling which generates sewage.

Subp. 26. **Percolation rate.** "Percolation rate" means the time rate of drop of a water surface in a test hole as specified in part 7080.0110, subpart 4.

Subp. 27. **Permitting authority.** "Permitting authority" means any state agency or local unit of government which administers the provisions of these standards.

Subp. 28. **Plastic limit.** "Plastic limit" means a soil moisture content below which the soil may be manipulated for purposes of installing a soil treatment system, and above which manipulation will cause compaction and puddling.

Subp. 29. **Sand.** "Sand" means a soil texture composed by weight of at least 85 percent of soil particles ranging in size between 0.05 and 2.0 mm.

Subp. 30. **Seepage pit, or leaching pit, or dry well.** "Seepage pit, or leaching pit, or dry well" means an underground pit into which a sewage tank discharges effluent or other liquid waste and from which the liquid seeps into the surrounding soil through the bottom and openings in the side of the pit.

Subp. 31. **Septage.** "Septage" means those solids and liquids removed during periodic maintenance of a septic or aerobic tank, or those solids and liquids which are removed from a holding tank.

Subp. 32. **Setback.** "Setback" means a separation distance measured horizontally.

Subp. 33. **Sewage.** "Sewage" means any water carried domestic waste, exclusive of footing and roof drainage, from any industrial, agricultural, or commercial establishment, or any dwelling or any other structure. Domestic waste includes but is not limited to liquid waste produced by bathing, laundry, culinary operations, and liquid wastes from toilets and floor drains, and specifically excludes animal waste and commercial process water.

Subp. 34. **Sewage flow.** "Sewage flow" means flow as determined by measurement of actual water use or, if actual measurements are unavailable, as estimated by the best available data provided by the agency.

Subp. 35. **Sewage tank.** "Sewage tank" means a watertight tank used in the treatment of sewage and includes, but is not limited to, septic tanks and aerobic tanks.

Subp. 36. **Sewage tank effluent.** "Sewage tank effluent" means that liquid which flows from a septic or aerobic tank under normal operation.

Subp. 37. **Septic tank.** "Septic tank" means any watertight, covered receptacle designed and constructed to receive the discharge of sewage from a building sewer, separate solids from liquid, digest organic matter, and store liquids through a period of detention, and allow the clarified liquids to discharge to a soil treatment system.

Subp. 38. **Shoreland.** "Shoreland" means land located within the following distances from public waters: 1,000 feet from the ordinary high water mark of a lake, pond or flowage; and 300 feet from a river or stream or the landward extent of a flood plain designated by ordinance on such a river or stream, whichever is greater.

Subp. 39. **Site.** "Site" means the area bounded by the dimensions required for the proper location of the soil treatment system.

Subp. 40. **Slope.** "Slope" means the ratio of vertical rise or fall to horizontal distance.

Subp. 41. **Soil characteristics, limiting.** "Soil characteristics, limiting" means those soil characteristics which preclude the installation of a standard system, including but not limited to, evidence of water table or bedrock closer than three feet to the ground surface, and percolation rates faster than one-tenth or slower than 60 minutes per inch.

MINNESOTA RULES 1983

5693

INDIVIDUAL SEWAGE TREATMENT SYSTEMS 7080.0030

Subp. 42. **Soil textural classification.** "Soil textural classification," where soil particle sizes or textures are specified in this chapter, they refer to the soil textural classification in the Soil Survey Manual, Handbook No. 18, United States Department of Agriculture, 1951.

Subp. 43. **Soil treatment area.** "Soil treatment area" means that area of trench or bed bottom which is in direct contact with the filter material of the soil treatment system.

Subp. 44. **Soil treatment system.** "Soil treatment system" means a system whereby sewage tank effluent is treated and disposed of below the ground surface by filtration and percolation through the soil, and includes those systems commonly known as seepage bed, trench, drainfield, disposal field, and includes mounds, electroosmosis systems, and seepage pits.

Subp. 45. **Standard system.** "Standard system" means an individual sewage treatment system employing a building sewer, sewage tank, and the soil treatment system commonly known as seepage bed or trenches, drainfield, or leachfield.

Subp. 46. **Surface water flooding.** "Surface water flooding" means the 100-year flood plain along rivers and streams as defined by the Department of Natural Resources, or in the absence of such data, as defined by the largest flood of record; on lakes, high water levels as determined or recorded by the Department of Natural Resources or, in the case of no Department of Natural Resources record, by local records or experience. Other surface water flooding or high water areas should be determined by local information.

Subp. 47. **Ten-year flood.** "Ten-year flood" means that flood which can be expected to occur, on an average, of once in ten years; or the level to which flood waters have a ten percent chance of rising in any given year.

Subp. 48. **Toilet waste.** "Toilet waste" means fecal matter, urine, toilet paper, and any water used for flushing.

Subp. 49. **Valve box.** "Valve box" means any device which can stop sewage tank effluent from flowing to a portion of the soil treatment area, and includes, but is not limited to, caps or plugs on distribution or drop box outlets, divider boards, butterfly valves, gate valves, or other mechanisms.

Subp. 50. **Water table.** "Water table" means the highest elevation in the soil where all voids are filled with water, as evidenced by presence of water or soil mottling or other information.

Subp. 51. **Ordinary high water mark.** "Ordinary high water mark" means a mark delineating the highest water level which has been maintained for a sufficient period of time to leave evidence upon the landscape. The ordinary high water mark is commonly that point where the natural vegetation changes from predominantly aquatic to predominantly terrestrial.

Subp. 52. **Watertight.** "Watertight" means constructed so that no water can get in or out below the level of the outlet.

Subp. 53. **Wild and scenic river land use district.** "Wild and scenic river land use district" means those lands designated by the commissioner of the Department of Natural Resources as the protected land corridor along those rivers or river segments designated as wild, scenic, or recreational rivers.

Statutory Authority: *MS s 115.03 subd 1*

7080.0030 ADMINISTRATION BY STATE AGENCIES.

Individual sewage treatment systems which serve a single facility generating greater than 15,000 gallons per day shall conform to the requirements of these standards and shall make application for and obtain a state disposal system permit from the agency.

7080.0030 INDIVIDUAL SEWAGE TREATMENT SYSTEMS

5694

Collector systems which serve 15 dwellings or 5,000 gallons per day, whichever is less, shall conform to the requirements of these standards and shall make application for and obtain a state disposal system permit from the agency.

Individual sewage treatment systems serving establishments or facilities licensed or otherwise regulated by the state of Minnesota shall conform to the requirements of these standards.

Any individual sewage treatment system requiring approval by the state of Minnesota shall also comply with all local codes and ordinances.

Statutory Authority: *MS s 115.03 subd 1*

7080.0040 ADMINISTRATION BY LOCAL UNITS OF GOVERNMENT.

Subpart 1. Shoreland and floodplain areas, and wild scenic river land use districts. Pursuant to Minnesota Statutes, sections 104.04, 104.36, and 105.485, certain counties and municipalities must enact ordinances which comply with the appropriate regulations of the Minnesota Department of Natural Resources, some of which in turn require compliance with the regulations of the Minnesota Pollution Control Agency.

Subp. 2. Other areas. Outside of the above mentioned areas, these standards provide recommended guidelines for the adoption of local ordinances and for the design, location, construction, use, and maintenance of individual sewage treatment systems.

Subp. 3. Localized standards. Nothing in these standards shall prevent local units of government from enacting ordinances which provide more adequate sewage treatment under local conditions.

Statutory Authority: *MS s 115.03 subd 1*

7080.0050 SURFACE DISCHARGE.

Unless specifically permitted by the agency, sewage, sewage tank effluent, or seepage from a soil treatment system shall not be discharged to the ground surface, abandoned wells, or bodies of surface water, or into any rock or soil formation the structure of which is not conducive to purification of water by filtration, or into any well or other excavation in the ground.

All new or existing systems which discharge to surface waters or the ground surface must obtain either a National Pollutant Discharge Elimination System (NPDES) or State Disposal System Permit from the agency and shall comply with all requirements pertaining thereto.

Statutory Authority: *MS s 115.03 subd 1*

7080.0060 TREATMENT REQUIRED.

The system, or systems, shall be designed to receive all sewage from the dwelling, building, or other establishment served. Footing or roof drainage shall not enter any part of the system.

Statutory Authority: *MS s 115.03 subd 1*

7080.0070 SYSTEM COMPONENTS.

The system shall consist of a building sewer, sewage tank, and soil treatment system. All sewage shall be treated in a sewage tank or toilet waste treatment device, and the sewage tank effluent shall be discharged to the soil treatment system.

Statutory Authority: *MS s 115.03 subd 1*

MINNESOTA RULES 1983

5695

INDIVIDUAL SEWAGE TREATMENT SYSTEMS 7080.0100

7080.0080 PROHIBITED INSTALLATIONS.

Cesspools shall not be installed.

Statutory Authority: *MS s 115.03 subd 1*

7080.0090 SYSTEM SIZING.

Where the construction of additional bedrooms, the installation of mechanical equipment, or other factors likely to affect the operation of the system can be reasonably anticipated, the installation of a system for such anticipated need shall be required.

Statutory Authority: *MS s 115.03 subd 1*

7080.0100 ADVISORY COMMITTEE.

Subpart 1. **Creation.** There is hereby created an advisory committee on individual sewage treatment systems (ISTS) hereinafter referred to as the committee.

Subp. 2. **Duties.** The committee shall, subject to the approval of the agency:

A. review and advise the agency on revisions of standards and legislation relating to ISTS;

B. review technical data relating to ISTS;

C. develop and revise a technical manual on ISTS;

D. develop educational materials and programs for ISTS;

E. advise the agency and local unit of government on the administration of standards and ordinances pertaining to ISTS.

Subp. 3. **Membership.** The committee shall consist of 16 voting members. Of the 16 voting members:

A. one shall be a citizen of Minnesota, representative of the public;

B. one shall be from the Agricultural Extension Service of the United States Department of Agriculture and the University of Minnesota;

C. six shall be county administrators (such as zoning administrators, sanitarians, etc.), one from each of the five agency regions and one from the seven-county metropolitan area;

D. one shall be a municipal building inspector;

E. six shall be sewage treatment contractors, one from each of the five agency regions and one from the seven-county metropolitan area; and

F. one shall be a water well contractor.

Subp. 4. **Ex officio members.** The following agencies and associations shall each have one nonvoting ex officio member to assist the advisory committee and to be advised, in turn, on matters relating to ISTS: the agency, the DNR, Department of Health, the United States Department of Agriculture Soil Conservation Service, the Metropolitan Council, the Association of Minnesota Counties, the Minnesota Association of Township Officials, the League of Minnesota Cities, and the Minnesota Society of Professional Engineers.

Subp. 5. **Appointment; terms.** All members shall be appointed by the agency board from recommendations by the affected groups. All members shall serve for two years, with terms staggered so as to maintain continuity.

In the case of a vacancy, an appointment shall be made for the unexpired balance of the term. The administrators, inspectors, and contractors shall have been bona fide residents of this state for a period of at least three years prior to appointment, and shall have had at least three years' experience in their respective businesses.

Subp. 6. **Robert's rules.** Robert's Rules of Order shall prevail at all meetings of the advisory committee.

Statutory Authority: *MS s 115.03 subd 1*

7080.0110 SITE EVALUATION.

Subpart 1. **Evaluation factors.** All proposed sites for individual sewage treatment systems shall be evaluated as to:

A. depth to the highest known or calculated ground water table or bedrock;

B. soil conditions, properties, and permeability;

C. slope;

D. the existence of lowlands, local surface depressions, and rock outcrops;

E. all legal setback requirements from: existing and proposed buildings; property lines; sewage tanks; soil treatment systems; water supply wells; buried water pipes and utility lines; the ordinary high water mark of lakes, rivers, streams, flowages; and the location of all soil treatment systems and water supply wells on adjoining lots within 150 feet of the proposed soil treatment system, sewage tank, and water supply well; and

F. surface water flooding probability.

Subp. 2. **Preliminary evaluation.** A preliminary evaluation shall be made of publicly available, existing data. If this evaluation, in the opinion of the permitting authority, yields enough information that the site is suitable, approval may be given for the installation of a standard system as specified in part 7080.0170, subpart 2. If a preliminary evaluation does not produce sufficient information, a field evaluation shall be made to determine the necessary information as specified in subpart 1.

Subp. 3. **Procedures for soil borings.** Where soil borings are required, they shall be made as follows:

A. Each boring or excavation shall be made to a depth at least three feet deeper than the bottom of the proposed system or until bedrock or a water table is encountered, whichever is less.

B. A soil texture description shall be recorded by depth and notations made where texture changes occur.

C. Particular effort shall be made to determine the highest known water table by recording the first occurrence of mottling observed in the hole, or if mottling is not encountered, the open holes in clay or loam soils shall be observed after standing undisturbed a minimum of 16 hours, and depth to standing water, if present, shall be measured.

Subp. 4. **Procedures for percolation tests.** Where percolation tests are required, they shall be made as follows:

A. Test hole dimensions and locations:

(1) Each test hole shall be six to eight inches in diameter, have vertical sides, and be bored or dug to the depth of the bottom of the proposed individual sewage treatment system.

(2) Soil texture descriptions shall be recorded noting depths where texture changes occur.

B. Preparation of the test hole:

(1) The bottom and sides of the hole shall be carefully scratched to remove any smearing and to provide a natural soil surface into which water may penetrate.

(2) All loose material shall be removed from the bottom of the test hole and two inches of one-fourth to three-fourths inch gravel shall be added to protect the bottom from scouring.

MINNESOTA RULES 1983

5697

INDIVIDUAL SEWAGE TREATMENT SYSTEMS 7080.0130

C. Soil saturation and swelling:

(1) The hole shall be carefully filled with clear water to a minimum depth of 12 inches over the soil at the bottom of the test hole and maintained for no less than four hours.

(2) The soil shall then be allowed to swell for at least 16, but no more than 30 hours. In sandy soils, the saturation and swelling procedure shall not be required and the test may proceed if one filling of the hole has seeped away in less than ten minutes.

D. Percolation rate measurement: In sandy soils adjust the water depth to eight inches over the soil at the bottom of the test hole. From a fixed reference point, the drop in water level shall be measured in inches to the nearest one-eighth inch at approximately ten minute intervals. A measurement can also be made by determining the time it takes for the water level to drop one inch from an eight-inch reference point. If eight inches of water seeps away in less than ten minutes, a shorter interval between measurements shall be used, but in no case shall the water depth exceed eight inches. The test shall continue until three consecutive percolation rate measurements vary by a range of no more than ten percent.

In other soils, adjust the water depth to eight inches over the soil at the bottom of the test hole. From a fixed reference point, the drop in water level shall be measured in inches to the nearest one-eighth inch at approximately 30-minute intervals, refilling between measurements to maintain an eight-inch starting head. The test shall continue until three consecutive percolation rate measurements vary by a range of no more than ten percent. The percolation rate can also be made by observing the time it takes the water level to drop one inch from an eight-inch reference point if a constant water depth of at least eight inches has been maintained for at least four hours prior to the measurement.

E. Calculating the percolation rate. Divide the time interval by the drop in water level to obtain the percolation rate in minutes per inch. Percolation rates determined for each test hole shall be averaged to determine the final soil treatment system design.

F. Reporting percolation rates. For reporting the percolation rate, worksheets showing all calculations and measurements shall be submitted.

G. Frost. A percolation test shall not be run where frost exists below the depth of the proposed soil treatment system.

Statutory Authority: *MS s 115.03 subd 1*

7080.0120 BUILDING SEWERS.

The design, construction, and location of, and the materials for use in building sewers are presently governed by the Minnesota Building Code SBC 8701 which incorporates by reference the Minnesota Plumbing Code, parts 4715.0100 to 4715.6000, and by specific provisions of the Minnesota Water Well Construction Code, part 4725.2000, subpart 1, items D, E, and F. Relevant portions of the Minnesota Plumbing Code, as of the date of enactment of this chapter, are reproduced in part 7080.0220. Part 4725.2000, subpart 1, items D, E, and F, as of the date of enactment of this chapter, are reproduced in 7080.0230.

Statutory Authority: *MS s 115.03 subd 1*

7080.0130 SEWAGE TANKS.

Subpart 1. In general. All tanks, regardless of material or method of construction, shall be:

A. watertight;

B. so designed and constructed as to withstand all lateral earth pressures under saturated soil conditions with the tank empty;

C. so designed and constructed as to withstand a minimum of seven feet of saturated earth cover above the tank top; and

D. not subject to excessive corrosion or decay.

Any tank not having an integrally cast bottom shall not be installed when the water table is closer than three inches to the bottom of the excavation at the time of construction.

Subp. 2. **Design of septic tanks.** All tanks, regardless of material or method of construction, shall conform to the following criteria:

A. The liquid depth of any septic tank or compartment thereof shall be not less than 30 inches. A liquid depth greater than six and one-half feet shall not be considered in determining tank capacity.

B. No tank or compartment thereof shall have an inside horizontal dimension less than 24 inches.

C. Inlet and outlet connections of the tank shall be submerged by means of baffles.

D. The space in the tank between the liquid surface and the top of the inlet and outlet baffles shall be not less than 20 percent of the total required liquid capacity, except that in horizontal cylindrical tanks this space shall be not less than 15 percent of the total required liquid capacity.

E. Inlet and outlet baffles shall be constructed of acid resistant concrete, acid resistant fiberglass, or plastic.

F. Sanitary tees shall be affixed to the inlet or outlet pipes with a permanent waterproof adhesive. Baffles shall be integrally cast with the tank, affixed with a permanent waterproof adhesive or affixed with stainless steel connectors, top and bottom.

G. The inlet baffle shall extend at least six inches but not more than 20 percent of the total liquid depth below the liquid surface and at least one inch above the crown of the inlet sewer.

H. The outlet baffle and the baffles between compartments shall extend below the liquid surface a distance equal to 40 percent of the liquid depth except that the penetration of the indicated baffles or sanitary tees for horizontal cylindrical tanks shall be 35 percent of the total liquid depth. They also shall extend above the liquid surface as required in item D. In no case shall they extend less than six inches above the liquid surface.

I. There shall be at least one inch between the underside of the top of the tank and the highest point of the inlet and outlet devices.

J. The inlet invert shall be not less than three inches above the outlet invert.

K. The inlet and outlet shall be located opposite each other along the axis of maximum dimension. The horizontal distance between the nearest points of the inlet and outlet devices shall be at least four feet.

L. Sanitary tees shall be at least four inches in diameter. Inlet baffles shall be no less than six inches or no more than 12 inches measured from the end of the inlet pipe to the nearest point on the baffle. Outlet baffles shall be six inches measured from beginning of the outlet pipe to the nearest point on the baffle.

M. Access to the septic tank shall be as follows:

(1) There shall be one or more manholes, at least 20 inches least dimension, and located within six feet of all walls of the tank. The manhole shall extend through the cover to a point within 12 inches but no closer than six inches below finished grade. The manhole cover shall be covered with at least six inches of earth.

(2) There shall be an inspection pipe of at least four inches diameter or a manhole over both the inlet and outlet devices. The inspection pipe shall extend through the cover and be capped flush or above finished grade.

MINNESOTA RULES 1983

5699

INDIVIDUAL SEWAGE TREATMENT SYSTEMS 7080.0130

A downward projection of the center line of the inspection pipe shall be directly in line with the center line of the inlet or outlet device.

N. Compartmentation of single tanks.

(1) Septic tanks larger than 3,000 gallons and fabricated as a single unit shall be divided into two or more compartments.

(2) When a septic tank is divided into two compartments, not less than one-half nor more than two-thirds of the total volume shall be in the first compartment.

(3) When a septic tank is divided into three or more compartments, one-half of the total volume shall be in the first compartment and the other half equally divided in the other compartments.

(4) Connections between compartments shall be baffled so as to obtain effective retention of scum and sludge. The submergence of the inlet and outlet baffles of each compartment shall be as specified in items G and H.

(5) Adequate venting shall be provided between compartments by baffles or by an opening of at least 50 square inches near the top of the compartment wall.

(6) Adequate access to each compartment shall be provided by one or more manholes, at least 20 inches least dimension, and located within six feet of all walls of the tank. The manhole shall extend through the cover to a point within 12 inches but no closer than six inches below finished grade. The manhole cover shall be covered with at least six inches of earth.

O. Multiple tanks.

(1) Where more than one tank is used to obtain the required liquid volume, the tanks shall be connected in series.

(2) Each tank shall comply with all other provisions of subpart 1.

(3) No more than four tanks in series can be used to obtain the required liquid volume.

(4) The first tank shall be no smaller than any subsequent tanks in series.

Subp. 3. Capacity of septic tanks. Capacity of septic tanks:

A. Dwellings. The liquid capacity of a septic tank serving a dwelling shall be based on the number of bedrooms contemplated in the dwelling served and shall be at least as large as the capacities given below (see part 7080.0200, subpart 7):

Number of Bedrooms	Tank Liquid Capacities (gallons)
2 or less	750
3 or 4	1,000
5 or 6	1,500
7, 8 or 9	2,000

For ten or more bedrooms, the septic tank shall be sized as another establishment. See item B.

B. Other establishments. The liquid capacity of a septic tank serving an establishment other than a dwelling shall be sufficient to provide a sewage detention period of not less than 36 hours in the tank for sewage flows less than 1,500 gallons per day, but in no instance shall the liquid capacity be less than 750 gallons. For sewage flows greater than 1,500 gallons per day the minimum liquid capacity shall equal 1,125 gallons plus 75 percent of the daily sewage flow.

Subp. 4. Location of septic tanks. The sewage tank shall be placed so that it is accessible for the removal of liquids and accumulated solids.

The sewage tank shall be placed on firm and settled soil capable of bearing the weight of the tank and its contents.

MINNESOTA RULES 1983

7080.0130 INDIVIDUAL SEWAGE TREATMENT SYSTEMS

5700

Sewage tanks shall be set back as specified in Table IV, part 7080.0170, subpart 2.

Sewage tanks shall not be placed in areas subject to flooding or in flood plains delineated by local ordinances adopted in compliance with the "State-wide Standards for Management of Flood Areas of Minnesota" (parts 6120.5100 to 6120.6200), or in areas for which regional flood information is available from the DNR, except that in areas where ten year flood information is available from and/or approved by the DNR, sewage tanks may be installed in accordance with all provisions of part 7080.0210, subpart 3, item F.

Subp. 5. Maintenance of septic tanks. The owner of any septic tank or his agent shall regularly inspect and arrange for the removal and sanitary disposal of septage from the tank whenever the top of the sludge layer is less than 12 inches below the bottom of the outlet baffle or whenever the bottom of the scum layer is less than three inches above the bottom of the outlet baffle.

Subp. 6. Aerobic tanks. Aerobic tank treatment systems shall comply with the general requirements for sewage tanks set forth in subpart 1, and with the following:

A. The treatment system including each individual unit or compartment shall be easily accessible for inspection and maintenance and shall be provided with secured covers.

B. The raw sewage flow from the dwelling shall be intercepted by a trash trap prior to its entering the aeration compartment. The trash trap shall have a net holding capacity of not less than 20 percent of the average daily flow. The invert level to the trap shall be above the liquid level and discharge directly into the trap. The outlet from the trap to the aeration compartment shall be deep baffled or equipped with a tee or long ell.

C. The trash trap shall be readily accessible for inspection and effective cleaning and shall be so constructed as to prevent unauthorized entry.

D. The aeration compartment shall have a minimum holding capacity of 500 gallons or 120 gallons per bedroom, whichever is greater.

E. The method of aeration shall be accomplished by mechanical aeration, diffused air, or both. The method used shall maintain aerobic conditions at all times.

F. The settling compartment shall have a minimum net holding capacity equal to 20 percent of the volume of the aeration compartment. The design shall provide for effective settling and continuous return of settled sludge to the aeration compartment.

G. A minimum one year warranty and an initial two year service contract which specifies regular inspection calls and effluent quality checks shall be provided as a part of the purchase agreement.

H. All other features of the aerobic tanks not specifically mentioned above shall comply with National Sanitation Foundation Standard No. 40 (November 1970).

Statutory Authority: *MS s 115.03 subd 1*

7080.0150 DISTRIBUTION OF EFFLUENT.

Subpart 1. Gravity distribution. Gravity distribution:

A. Level ground. Where the elevation difference of the ground surface does not exceed 28 inches in any direction within the soil treatment system, the sewage tank effluent may be directed to the soil treatment system through a system of interconnected distribution pipes or trenches in a continuous system.

B. Slightly sloping ground.

MINNESOTA RULES 1983

5701

INDIVIDUAL SEWAGE TREATMENT SYSTEMS 7080.0150

(1) Sewage tank effluent may be distributed by a distribution box provided the final ground surface elevation of the lowest trench is at least one foot higher than the outlet inverts of the distribution box.

(2) Distribution box.

(a) The box shall be watertight with a removable cover and shall be constructed of durable materials not subject to excessive corrosion or decay.

(b) The inverts of all outlets shall be at the same elevation as measured from a liquid surface in the bottom of the box.

(c) The inlet invert shall be at least one inch above the outlet inverts.

(d) The outlet inverts shall be at least four inches above the distribution box floor.

(e) Each drain field trench line shall be connected separately to the distribution box and shall not be subdivided.

(f) When sewage tank effluent is delivered to the distribution box by pump, either a baffle wall shall be installed in the distribution box or the pump discharge shall be directed against a wall or side of the box on which there is no outlet. The baffle shall be secured to the box and shall extend at least one inch above the crown of the inlet flow line.

C. Sloping ground.

(1) Where the elevation difference of the ground surface exceeds 28 inches in any direction within the soil treatment system and a distribution box cannot be used as specified in item B, a drop box shall be installed at the head end of each lateral line. Connections between drop boxes shall be by watertight pipes.

(2) Drop boxes.

(a) The drop box shall be watertight and constructed of durable materials not subject to excessive corrosion or decay.

(b) The invert of the inlet pipe shall be at least one inch higher than the invert of the outlet pipe to the next trench.

(c) The invert of the outlet pipe to the next trench shall be at least two inches higher than the invert of the outlet pipe of the trench in which the box is located.

(d) When sewage tank effluent is delivered to the drop box by a pump, the pump discharge shall be directed against a wall or side of the box on which there is no outlet.

(e) The drop box shall have a removable cover either flush or above finished grade or covered by no more than six inches of soil.

Subp. 2. **Pressure distribution.** Pressure distribution laterals shall be sized as shown in Table I below.

Laterals shall be spaced no further than 20 inches from a trench or bed wall.

Laterals shall be spaced no further than 40 inches apart.

Laterals shall be connected to a header pipe which is at least one and one-half inch and no more than two inches in diameter.

TABLE I

Maximum Allowable Lateral Lengths In Feet From Header Pipe
Perforation Spacing

Perf. Dia.	2.5 Feet Pipe Dia.			3.0 Feet Pipe Dia.		
	1"	1-1/4"	1-1/2"	1"	1-1/4"	1-1/2"

MINNESOTA RULES 1983

7080.0150 INDIVIDUAL SEWAGE TREATMENT SYSTEMS

5702

3/16"	34	52	70	36	60	75
7/32"	30	45	57	33	51	63
1/4"	25	38	50	27	42	54

Statutory Authority: *MS s 115.03 subd 1*

7080.0160 DOSING OF EFFLUENT.

Subpart 1. **Dosing chamber.** A dosing device is not necessary in all situations but, where used, shall comply with the following requirements:

A. The dosing chamber shall be watertight and constructed of sound and durable materials not subject to excessive corrosion or decay.

B. There shall be one or more manholes, at least 20 inches least dimension and preferably located directly above the dosing device. The manhole shall extend through the dosing chamber cover to final grade and shall be so constructed as to prevent unauthorized entry.

C. The size of the effluent dose shall be determined by design of the soil treatment unit but in no case shall the dosing chamber be sized to provide a dose of less than 75 gallons.

Subp. 2. **Dosing devices for gravity distribution.** Dosing devices for gravity distribution:

A. Where a dosing device is employed, a pump or siphon shall deliver the dose to the soil treatment unit for gravity distribution over the soil treatment area.

B. For dwellings, the dosing device shall discharge at least 600 gallons per hour but no more than 2,700 gallons per hour.

C. For other establishments, the dosing device should discharge at a rate at least ten percent greater than the water supply flow rate but no faster than the rate at which effluent will flow out of the distribution device.

D. If the dosing device is a siphon, a maintenance inspection shall be made every six months by the owner or his agent. The siphon shall be maintained in proper operating condition.

E. If the dosing device is a pump, it shall be cast iron or bronze fitted and with stainless steel screws or constructed of other sound, durable, and corrosion-resistant materials.

F. Where the soil treatment area is at a higher elevation than the pump, sufficient dynamic head shall be provided for both the elevation difference and friction loss.

G. Where the dosing device is a pump, an alarm device shall be installed to warn of pump failure.

Subp. 3. **Dosing devices for pressure distribution.** Dosing devices for pressure distribution:

A. The dosing device shall be a pump which is cast iron or bronze fitted and with stainless steel screws or constructed of sound, durable, and corrosion-resistant materials.

B. The pump discharge capacity shall be at least seven and one-half gallons per minute for each 100 square feet of soil treatment area.

C. The pump discharge head shall be at least five feet greater than the head required to overcome pipe friction losses and the elevation difference between the pump and the distribution device.

D. The quantity of effluent delivered for each pump cycle shall be no greater than 25 percent of one day's sewage flow.

E. An alarm device shall be installed to warn of pump failure.

Statutory Authority: *MS s 115.03 subd 1*

MINNESOTA RULES 1983

5703

INDIVIDUAL SEWAGE TREATMENT SYSTEMS 7080.0170

7080.0170 FINAL TREATMENT AND DISPOSAL.

Subpart 1. **In general.** Final treatment and disposal of all sewage tank effluent shall be by means of soil treatment and disposal.

Subp. 2. **Standard system.**

A. **Sizing:**

(1) The required soil treatment area shall be determined by the daily sewage flow and the percolation rate of the soil.

(2) Acceptable methods for estimating sewage flow for dwellings are given in Table II. The minimum daily sewage flow estimated for any dwelling shall provide for at least two bedrooms. For multiple residential units, the estimated daily sewage flow shall consist of the sum of the flows of each individual unit.

Table II. Sewage flow (gallons per day).

Number of Bedrooms	Classification of Dwelling*			
	I	II	III	IV
2	300	225	180	-
3	450	300	218	-
4	600	375	256	-
5	750	450	294	-
6	900	525	332	-

*Table II is based on the following formulas:

Classification I: Sewage Flow = 150 (No. of Bedrooms)

Classification II: Sewage Flow = 75 (No. of Bedrooms + 1)

Classification III: Sewage Flow = 66 + 38 (No. of Bedrooms + 1)

Classification IV: If a greywater system is employed pursuant to Appendix A, subpart 4, item B, in part 7080.0210, estimated sewage flow shall equal 60 percent of the amount provided in column I, II, or III of Table II.

(3) For other establishments, the daily sewage flow shall be determined as provided in part 7080.0020, subpart 34.

(4) The soil treatment area shall be at least as large as set forth in

Table III.

Table III.

Percolation Rate (Minutes per inch)	Required Soil Treatment Area in Square Feet (Per Gallon of Sewage Flow per Day)
Faster than 0.1**	-
0.1 to 5***	0.83
6 to 15	1.27
16 to 30	1.67
31 to 45	2.00
46 to 60	2.20
Slower than 60****	-

**Soil is unsuitable for standard system if percolation rate is less than 0.1 minutes per inch. See Appendix A, subpart 3, item E, in part 7080.0210.

***Consider alternative sewage treatment systems for soils with this percolation rate range. See Appendix A, subpart 3, item E, in part 7080.0210.

****Soil is unsuitable for standard system if percolation rate is slower than 60 minutes per inch. See Appendix A, subpart 3, item D, in part 7080.0210.

(5) Table III gives the required bottom area assuming six inches of filter material below the distribution pipe for trenches and beds. The required bottom area may be reduced, for trenches only, by the following percentages: 20 percent for 12 inches of filter material below the distribution pipe; 34 percent

MINNESOTA RULES 1983

7080.0170 INDIVIDUAL SEWAGE TREATMENT SYSTEMS

5704

for 18 inches; and 40 percent for 24 inches. The filter material shall completely encase the distribution pipe to a depth of at least two inches.

B. Location:

(1) On slopes in excess of 12 percent, the soil profile shall be carefully evaluated in the location of the proposed soil treatment system and downslope to identify the presence of layers with different permeabilities that may cause sidehill seepage. In no case shall a trench be located within 15 feet of where such a layer surfaces on the downslope.

(2) Bed construction shall be limited to areas having natural slopes of less than six percent.

(3) Soil treatment systems shall be located as specified in Table IV in subpart 8.

(4) Soil treatment areas shall not be placed in areas subject to flooding or in flood plains delineated by local ordinances adopted in compliance with the "State-wide Standards and Criteria for Management of Flood Plain Areas of Minnesota" (parts 6120.5100 to 6120.6200), or in areas for which regional flood information is available from the DNR, except that in areas where ten year flood information is available from and/or approved by the DNR, soil treatment systems may be installed in accordance with the provisions of Appendix A, part 7080.0210, subpart 3, item F.

C. Design and construction:

(1) The bottom of trenches and beds shall be at least three feet above the water table or bedrock.

(2) The trenches shall be not less than 18 inches nor more than 36 inches wide. Any trench wider than 36 inches shall be considered a bed.

(3) Trenches and beds shall be not more than 100 feet in length.

(4) The bottom of the trench or bed excavation shall be level.

(5) The bottom and sides of the soil treatment system to the top of the filter material shall be excavated in such a manner as to leave the soil in a natural, unsmearred, and uncompacted condition. Excavation shall be made only when the soil moisture content is at or less than the plastic limit.

(6) When the percolation rate is slower than 15 minutes per inch, excavation shall be by backhoe or other means that allow the equipment wheels or tracks to remain on the surface soil. Excavation equipment or other vehicles shall not be driven on the soil treatment area.

(7) There shall be a layer of at least six but no more than 24 inches of filter material in the bottom of the trenches and beds.

(8) Where disposal trenches are constructed within ten feet of trees six inches or larger in diameter, or dense shrubbery, or where it can reasonably be anticipated that such vegetation will be present during the expected life of the system, at least 12 inches of filter material shall be placed beneath the distribution pipe.

(9) Distribution pipes, gravity distribution.

(a) Distribution pipe used in trenches or beds for gravity flow distribution shall be at least four inches in diameter and constructed of sound and durable material not subject to corrosion or decay or to loss of strength under continuously wet conditions.

(b) Perforated pipe used for sewage distribution pipes shall have one or more rows of holes of no less than one-half inch in diameter spaced no more than 36 inches apart. Holes shall be spaced to prevent failure due to loads. Distribution pipes shall have a load bearing capacity of not less than 1,000 pounds per lineal foot.

MINNESOTA RULES 1983

5705

INDIVIDUAL SEWAGE TREATMENT SYSTEMS 7080.0170

(c) Agricultural drain tile shall be in 12-inch lengths and laid with one-fourth inch open joints on grade boards. All open joints shall be protected on top by strips of asphalt-treated building paper at least ten inches long and three to six inches wide or by other acceptable means.

(d) Other devices may be used to distribute sewage tank effluent over the soil treatment area upon approval of the permitting authority.

(10) Pressure distribution.

(a) Distribution pipes used in trenches or beds for pressure distribution shall be at least one inch in diameter and constructed of sound and durable material not subject to corrosion or decay or to loss of strength under continuously wet conditions.

(b) Perforations shall be sized and spaced as shown in Table I set forth in part 7080.0150, subpart 2.

(11) The distribution pipes shall be laid level or on a uniform slope away from the distribution device of no more than four inches per 100 feet.

(12) Gravity distribution pipes in beds shall be uniformly spaced no more than five feet apart and not more than 30 inches from the side walls of the bed.

(13) The filter material shall completely encase the disposal pipes to a depth of at least two inches.

(14) The filter material shall be covered with untreated building paper or a two-inch layer of hay or straw or similar, approved permeable materials.

(15) The trenches or beds shall be backfilled and crowned above finished grade to allow for settling. The top six inches of soil shall have the same texture and density as the adjacent soil.

(16) The minimum depth of cover over the distribution pipes shall be at least eight inches. The maximum depth of cover over the distribution pipes shall be no more than 36 inches and preferably no more than 24 inches.

(17) A grass cover shall be established by the owner or his agent over the soil treatment system.

D. Dual field systems:

(1) Dual field systems shall be used only where the percolation rate is slower than five minutes per inch.

(2) Dual field systems shall be sized, designed, and constructed as set forth above for standard systems except as follows:

(a) The soil treatment area shall be divided into two or more parts.

(b) Alternating soil treatment areas shall each be connected to a valve box outlet.

(3) A part of the soil treatment area shall be used no more than one year unless inspection of the effluent level indicates that a longer duration can be used.

Table IV. Minimum setback distances (feet).

Feature	Sewage Tank	Soil Treatment Area
Water Supply well less than 50 feet deep and not encountering at least ten feet of impervious material	*	*
Any other water supply well or buried water suction	*	*

MINNESOTA RULES 1983

7080.0170 INDIVIDUAL SEWAGE TREATMENT SYSTEMS

5706

pipe

Buried pipe distributing
water under pressure

*

*

Buildings

10

20

Property Lines

10

10

The Ordinary High Water
Mark of:

Natural Environment
Lakes and Rivers

**

**

Recreational Development
Lakes and Streams

**

**

General Development
Lakes and Streams

**

**

Wild Rivers

**

**

Scenic Rivers

**

**

Recreational Rivers and
Designated Tributaries
of Wild, Scenic, and
Recreational Rivers

**

**

* Setbacks from water supply wells and buried water pipes are presently governed by part 4725.2000, subpart 1, items D, E, and F. These rules, as of the date of enactment of this part, are reproduced in Appendix D, part 7080.0230.

** Setbacks from lakes, rivers and streams are presently governed by parts 6120.1300, 6105.0120, and 6120.3400. These rules, as of the date of enactment of this part, are reproduced in Appendix E, part 7080.0240.

Statutory Authority: *MS s 115.03 subd 1*

7080.0180 ALTERNATIVE SYSTEMS.

Where limiting soil characteristics exist, special systems of sewage treatment and disposal, including but not limited to those in Appendix A, part 7080.0210, may be employed provided:

A. reasonable assurance of performance of such system is presented to the permitting authority;

B. the engineering design of such system is first approved by the permitting authority;

C. there is no discharge to the ground surface or to surface waters;

D. treatment and disposal of wastes is in such a manner so as to protect the public health and general welfare; and

E. such systems comply with all applicable requirements of these standards and with all local codes and ordinances.

Statutory Authority: *MS s 115.03 subd 1*

MINNESOTA RULES 1983

5707

INDIVIDUAL SEWAGE TREATMENT SYSTEMS 7080.0210

7080.0190 SEVERABILITY.

If any provision of these standards or the application thereof to any person or circumstances is held to be invalid, such invalidity shall not affect other provisions of these standards or application of any other part of these standards which can be given effect without application of the invalid provision. To this end the provisions of all sections, subsections, or subdivisions herein and the various applications thereof are declared to be severable.

Statutory Authority: *MS s 115.03 subd 1*

7080.0200 VARIANCE.

In any cases where a permit is required by the agency and, upon application of the responsible person or persons, the agency finds that by reason of exceptional circumstances the strict enforcement of any provision of these standards would cause undue hardship, that disposal of the sewage, industrial waste, or other waste is necessary for the public health, safety, or welfare, or that strict conformity with the standards would be unreasonable, impractical, or not feasible under the circumstances, the agency in its discretion may permit a variance therefrom upon such conditions as it may prescribe for prevention, control, or abatement of pollution in harmony with the general purpose of these standards and the intent of applicable state and federal laws.

Statutory Authority: *MS s 115.03 subd 1*

7080.0210 APPENDIX A: ALTERNATIVE SYSTEMS.

Subpart 1. General. The intent of this appendix is to provide standards for the design, location, installation, use, and maintenance of alternative sewage treatment systems in areas of limiting soil characteristics, or where a standard system cannot be installed or is not the most suitable treatment. Where such systems are employed, they shall comply with all local codes and ordinances, and be subject to timely inspections to assure adherence to specifications.

Subp. 2. Adoption and use. Where parts 7080.0010 to 7080.0240 are administered by a local unit of government, those local units of government may adopt this appendix, in whole or in part, as part of a local code or ordinance. Nothing in parts 7080.0010 to 7080.0240 or this appendix, however, shall require the adoption of any part of this appendix as local ordinance or code. Further, nothing in parts 7080.0010 to 7080.0240 or this appendix shall require local units of government to allow the installation of any system in this appendix.

This appendix defines the minimum requirements for alternative systems serving establishments or facilities licensed or otherwise regulated by the state of Minnesota or this agency pursuant to part 7080.0030.

Subp. 3. Class I alternatives, modified standard systems.

A. Extreme caution and careful planning shall be employed wherever limiting characteristics including, but not limited to, water table or bedrock exist within two feet of the original ground surface.

B. Fluctuating ground water.

(1) Where natural drainage will not provide three feet of separation between the bottom of the soil treatment area and the highest known or calculated level of the water table, agricultural drain tile may be used to intercept or lower the seasonal high water table, except within shorelands of public waters. There shall be at least ten feet of undisturbed soil between the sidewall of the soil treatment unit and the agricultural drain tile.

(2) Within shorelands of public waters, agricultural drain tile may be used to intercept the seasonal high water table provided the ground water table has a slope of at least two feet per hundred feet toward the public water and provided the drain tile are installed upslope of the soil treatment system. There shall be at least 20 feet of undisturbed soil between the sidewall of the soil treatment unit and the agricultural drain tile.

(3) In all cases the greatest practicable vertical separation distance from the water table shall be provided.

C. Bedrock proximity. In no case shall filter material of the soil treatment system be placed closer than three feet to creviced bedrock or to consolidated permeable bedrock. When all horizons of the original soil profile have percolation rates slower than 60 minutes per inch, filter material of the soil treatment system shall be placed no closer than seven feet to consolidated impermeable bedrock. A maximum depth of 24 inches of sand may be used under the filter material. Where additional fill is required to achieve the required separation distance, a soil having a percolation rate between five and 45 minutes per inch (loamy sand to silt loam) 12 months after placement shall be used. If it is not possible to allow the soil to settle for 12 months after placement, mechanical methods may be used to settle the fill to within ten percent of its "in situ" density.

D. Slowly permeable soils.

(1) In no case shall excavation for the purpose of constructing a soil treatment system be made in any soil layer having a percolation rate slower than 120 minutes per inch.

(2) In no case shall excavation for the purpose of constructing a soil treatment system be made in a soil layer having a percolation rate slower than 60 minutes per inch unless the moisture content is lower than the plastic limit of the soil.

(3) In no case shall filter material be placed in contact with original soil having a percolation rate slower than 60 minutes per inch.

(4) Where the percolation rate of the original soil is slower than 60 minutes per inch, at least six inches but no more than 12 inches of fill material having a percolation rate of between five and 30 minutes per inch (loamy sands and loams) after placement shall be placed between the filter material and the original soil along the excavation bottom and sidewalls.

(5) In no case shall construction equipment, wheels, or tracks be placed in contact with the bottom of the excavation during the construction of a soil treatment system in soils having a percolation rate slower than 15 minutes per inch.

(6) The size of soil treatment system shall be based on the required treatment area for a soil having a percolation rate of 60 minutes per inch as specified in Table III set forth in part 7080.0170, subpart 2.

E. Rapidly permeable soils.

(1) Filter material for a soil treatment unit shall not be placed in contact with original soil having a percolation rate faster than one-tenth minute per inch.

(2) For coarse soils having a percolation rate faster than one-tenth minute per inch, at least six inches of sandy loam textured soil having a percolation rate between five and 15 minutes per inch after placement (loamy sand to sandy loam) shall be placed between the filter material and the coarse soil along the excavation bottom and sidewalls.

(3) For soils with percolation rates between one-tenth and five minutes per inch at least one of the following treatment techniques shall be used:

(a) provide at least six inches of sandy loam textured soil with a percolation rate between five and 15 minutes per inch after placement between the filter material and the coarse soil;

(b) distribution of sewage tank effluent by pressure flow over the treatment area as specified in part 7080.0150, subpart 2;

(c) divide the total soil treatment area into at least four equal parts connected serially.

MINNESOTA RULES 1983

5709

INDIVIDUAL SEWAGE TREATMENT SYSTEMS 7080.0210

F. Flood plain areas.

(1) The soil treatment area shall be a trench system with at least 12 inches of filter material below the distribution pipe. There shall be no pipe or other installed opening between the filter material and the soil surface.

(2) The trench system shall be located on the highest feasible area of the lot and shall have location preference over all other improvements except the water supply well. The bottom of the trench shall be at least as high as the elevation of the ten year flood. The sewage tank may be located so as to provide gravity flow to the soil treatment area.

(3) If a pumping station is used to move effluent from the sewage tank to the drain field, provisions shall be made to prevent the pump from operating when inundated with flood waters.

(4) When fill is needed to raise the elevation of the soil treatment area, a mound system may be used with the following additional requirement: The elevation of the mound shall be such that the elevation of the bottom of the rock layer shall be at least one-half foot above the ten-year flood elevation. Inspection wells shall not be installed unless the top of the mound is above the elevation of the regional flood.

(5) When the top of the sewage tank is inundated, the dwelling must cease discharging sewage into it. This may be accomplished by either temporarily evacuating the structure until the system again becomes functional, or by diverting the sewage into a holding tank sized and installed according to the requirements below.

(6) The building sewer shall be designed to prevent backflow of liquid into the building when the system is inundated. If a holding tank is utilized, the building sewer shall be designed to permit rapid diversion of sewage into the holding tank when the system is inundated.

(7) If a holding tank is utilized for a dwelling, its liquid capacity shall be equal to 100 gallons times the number of bedrooms times the number of days between the ten-year stage on the rising limb of the regional flood hydrograph and the ten-year stage on the falling limb of the hydrograph, or 1,000 gallons, whichever is greater. For other establishments, see subpart 7.

(8) Whenever the water level has reached a stage above the top of the sewage tank, the tank shall be pumped to remove all solids and liquids after the flood has receded before use of the system is resumed.

Subp. 4. Class II alternatives, reduced area systems.

A. Aerobic tanks. No additional reduction in soil treatment area shall be allowed with the use of an aerobic treatment tank.

B. Separate toilet waste and greywater systems.

(1) General. A toilet waste treatment device shall be used in conjunction with a greywater system. In all cases, only toilet wastes shall be discharged to toilet waste treatment devices. Greywater or garbage shall not be discharged to the device except as specifically recommended by a manufacturer.

(2) Toilet waste treatment devices.

(a) Toilet waste treatment devices shall be considered as one of two types: I, privies; and II, other devices, including, but not limited to, incinerating, composting, biological, chemical, recirculating, or holding toilets.

(b) Type I, privies. Pit privies shall not be installed where the bottom of the pit is less than three feet above the water table. A vault privy shall be used in areas of high ground water. The vault of a vault privy shall be constructed in the same manner as a septic tank. See part 7080.0130, subpart 1.

Privies shall be set back from surface waters the same distance as required for buildings and from property lines and water supply wells the same distance as required for soil treatment areas.

MINNESOTA RULES 1983

7080.0210 INDIVIDUAL SEWAGE TREATMENT SYSTEMS

5710

Pits or vaults shall be of sufficient capacity for the residence they serve, but shall have at least 50 cubic feet of capacity.

The sides of the pit shall be curbed to prevent cave-in.

The superstructure shall be constructed so as to be easily cleaned, and it shall be insect proof. The door and seat shall be self closing. All openings including vent openings, shall be screened.

Privies shall be adequately vented.

When the pit is filled to within one foot of the top the solids shall be removed or a new pit shall be constructed. The abandoned pit shall be filled with clean earth and slightly mounded to allow for settling. Removed solids shall be disposed of by land application in accordance with agency guidelines for septage disposal and all local ordinances and codes.

All liquids and solids removed from a vault privy shall be treated and disposed of by application in accordance with the agency's septage disposal guidelines.

(c) Type II, other devices. Other devices may be used where reasonable assurance of performance is provided.

All type II devices shall be vented.

All electric, gas, and water connections to a type II device shall conform to all local ordinances and codes.

Operation and maintenance of all type II devices shall follow the manufacturer's recommendations.

(d) All materials removed from a type I or II toilet waste treatment device, including but not limited to, ashes, compost, and all solids and liquids shall be disposed of in a public sewage system or by land application in accordance with the agency's septage disposal guidelines and all local ordinances and codes.

(3) Greywater system.

(a) Plumbing. The drainage system in new systems shall be based on a pipe diameter of two inches to prevent installation of a water flush toilet. There shall be no openings or connections to the drainage system, including floor drains, larger than two inches in diameter. For repair or replacement of an existing system, the existing drainage system may be used.

Toilets or urinals of any kind shall not be connected to the drainage system. Toilet waste or garbage shall not be discharged to the drainage system.

Garbage grinders shall not be connected to the drainage system.

(b) Building sewer. The building sewer shall meet all requirements of part 7080.0120 except that the building sewer for a greywater system shall be at least two inches in diameter.

(c) Sewage tank. Greywater septic tanks shall meet all requirements of part 7080.0130, subpart 1, except that the liquid capacity of a greywater septic tank serving a dwelling shall be based on the number of bedrooms contemplated in the dwelling served and shall be at least as large as the capacities given in table A-1. See parts 7080.0020, subpart 7, and 7080.0090.

Table A-1.

Number of Bedrooms	Tank Liquid Capacity (gallons)
2 or less or hand pump	300
3 or 4	500
5 or 6	750
7, 8 or 9	1,000

MINNESOTA RULES 1983

5711

INDIVIDUAL SEWAGE TREATMENT SYSTEMS 7080.0210

For ten or more bedrooms or other establishments, the greywater septic tank shall be sized as for any other establishment (see part 7080.0130, subpart 3, item B) except that the minimum liquid capacity shall be at least 300 gallons.

Greywater aerobic tanks shall meet all requirements of part 7080.0130, subpart 6.

(d) Distribution and dosing. Distribution and dosing of greywater shall meet all requirements of parts 7080.0150 and 7080.0160.

(e) Final treatment and disposal. Standard system. A standard greywater system shall meet all requirements of part 7080.0170.

Alternative system. A greywater mound system shall meet all requirements of subpart 6, item A.

C. Seasonal use. Where a commercial establishment is occupied or used for less than 180 days per year and less than 120 days consecutively, the maximum daily sewage flow shall be determined and the average daily sewage flow shall be computed by dividing the total annual estimated or measured sewage flow by 365 days. The size of the soil treatment system shall be based on the average daily sewage flow and the areas specified in table III set forth in part 7080.0170, subpart 2. All other requirements of soil treatment system construction shall be followed.

The maximum daily sewage flow shall be used to determine sewage tank size for other establishments. There shall be no reduction in the size of sewage tanks for seasonal use.

In no case shall a seasonal use establishment be converted to full time use until the soil treatment system meets the size requirements of table III set forth in part 7080.0170, subpart 2.

Subp. 5. Class III: alternatives, advanced alternative system.

A. Mounds.

(1) Mounds may be constructed on soils having the site or soil conditions specified in Appendix A, subpart 3.

(2) The soil percolation rate in all layers of the natural or fill soil to a depth of at least 24 inches below the sand, as specified in subitem (12), shall be faster than 120 minutes per inch.

(3) Below the sand layer there shall be at least one layer of soil, either natural or fill, at least 12 inches thick, which has a percolation rate slower than five minutes per inch (loamy sand).

(4) Wherever possible, mounds shall be located on flat areas or crests of slopes. Mounds shall not be located on natural slopes of more than three percent if the percolation rate is slower than 60 minutes per inch to a depth of at least 24 inches below the sand layer.

(5) Mounds shall not be located on slopes exceeding six percent if the soil percolation rate is slower than 30 minutes per inch to a depth of at least 24 inches below the sand layer.

(6) Mounds shall not be located on natural slopes exceeding 12 percent under any soil percolation rate conditions.

(7) The bottom area of the filter material shall be sized on the basis of 0.83 square feet per gallon of waste per day.

(8) In no case shall the width of the filter material in a single bed exceed ten feet.

(9) A rubber tired tractor may be used for plowing or discing but in no case shall a rubber tired tractor be used after the surface preparation is completed where the soil is slower than 15 minutes per inch. A crawler or track type tractor shall be used for mound construction where the soil is slower than 15 minutes per inch.

(10) The discharge pipe from the pump to the mound area shall be installed prior to soil surface preparation. The trench shall be carefully backfilled and compacted to prevent seepage of effluent.

(11) Soil surface preparation. The total area selected for the mound, including the dikes, shall be plowed to a depth of at least eight inches or the sod layer broken and roughened by backhoe teeth. Furrows shall be thrown uphill and there shall be no dead furrow under the mound. The soil shall be plowed only when the moisture content of a fragment eight inches below the surface is below the plastic limit. In soils having percolation rates faster than 15 minutes per inch (sandy loam) in the top eight-inch depth, discing may be used for surface preparation as a substitute for plowing. Mound construction shall proceed immediately after surface preparation is completed.

(12) A minimum of twelve inches of soil defined as sand shall be placed where the filter material is to be located. A crawler tractor with a blade shall be used to move the sand into place. At least six inches of sand shall be kept beneath equipment to minimize compaction of the plowed layer. The sand layer upon which the filter material is placed shall be level.

(13) A depth of at least nine inches of filter material shall be placed over the bed area below the distribution pipe.

(14) Distribution of effluent over the filter material shall be either by four-inch distribution pipes with gravity flow from a distribution box or by perforated pipe under pressure from a manifold.

(15) Gravity distribution. The four-inch distribution pipes shall be rigid plastic with holes at least one-half inch diameter spaced no further than 36 inches. One row of holes shall be laid at the bottom of the pipe. The distribution pipe shall slope downward two inches per 100 feet away from the distribution box. The far ends of the distribution pipe shall be connected. The distribution pipes shall be spaced no further than five feet apart and no further than 30 inches from the edge of the filter material. The distribution pipes shall connect to the outlets of a distribution box. The quantity of effluent per pump dose shall be at least 25 percent of the estimated or measured daily sewage flow.

(16) Pressure distribution. Perforation holes shall be as set forth in table I set forth in part 7080.0150, subpart 2. Holes shall be drilled straight into the pipe and not at an angle. The perforated pipe laterals shall be connected to a two-inch diameter manifold pipe with the ends capped. The laterals shall be spaced no further than 40 inches on center and no further than 20 inches from the edge of the filter material. The perforated pipe laterals shall be installed level with the perforations downward. The manifold pipe shall be connected to the supply pipe from the pump. The manifold shall be sloped toward the supply pipe from the pump.

(17) At least two inches of filter material shall be placed over the lateral or distribution pipes.

(18) Straw or marsh hay to an uncompacted depth of three to four inches shall be placed over the filter material.

(19) Construction vehicles shall not be allowed on the filter material until backfill is placed.

(20) Sandy loam soil shall be placed on the filter material to a depth of one foot in the center of the mound and to a depth of six inches at the sides.

(21) A maximum of two ten-foot wide beds may be installed side by side in a single mound if the soil percolation rate is between five and 60 minutes per inch to a depth of at least 24 inches below the sand layer. The beds shall be separated by four feet of sand.

(22) When two beds are installed side by side the sandy loam fill at the center of the mound shall be 18 inches deep and six inches deep at the sides.

MINNESOTA RULES 1983

5713

INDIVIDUAL SEWAGE TREATMENT SYSTEMS 7080.0210

(23) Six inches of top soil shall be placed on the fill material over the entire area of the mound.

(24) A grass cover shall be established over the entire area of the mound.

(25) No shrubs shall be planted on the top of the mound. Shrubs may be placed at the foot and side slopes of the mound.

(26) The side slopes on the mound shall be no steeper than three to one.

(27) Whenever mounds are located on slopes, a diversion shall be constructed immediately upslope from the mound to intercept and direct runoff.

(28) A pump shall be used as specified in part 7080.0160, subpart 3.

B. Collector systems.

(1) In general. Where site or soil conditions do not allow for final treatment and disposal on an individual lot, a system whereby a soil treatment system is located on another lot or lots may be employed, where approved by the local unit of government.

Plans and specifications shall comply with local ordinances on such issues as zoning, joint ownership of land, joint maintenance responsibilities, easements, and other considerations and shall be approved by the local unit of government.

(2) Design.

(a) The size of common soil treatment systems shall be based on the sum of the areas required for each residence.

(b) The system shall be designed with each residence having a sewage tank or with a common sewage tank. In the case of a common tank, the capacity of the tank shall be sized according to part 7080.0130, subpart 2, item B, except that the minimum capacity shall be at least 3,000 gallons, and shall be compartmented if in a single tank.

(c) Sewer systems shall be designed on an estimated average daily flow for dwellings based on table II, set forth in part 7080.0170, subpart 2, plus estimated flows from other establishments.

(d) The sewer for systems with common sewage tanks shall be so constructed to give mean velocities, when flowing full, of not less than two feet per second. The sewer for systems with individual sewage tanks shall be so constructed and designed to hydraulically conduct the flow for which they were designed. In no case shall a gravity sewer be less than four inches in diameter.

(e) Infiltration or exfiltration shall not exceed 200 gallons per inch of pipe diameter per mile per day.

(f) Cleanouts, brought flush with or above finished grade, shall be provided wherever a common sewer joins an individual building sewer or piping from an individual sewer tank, or every 100 feet, whichever is less, unless manhole access is provided.

(g) There shall be no physical connection between sewers and water supply systems. Sewers shall be set back from water supply systems and piping as required for building sewers. Where it is not possible to obtain proper separation distances, the sewer connections shall be watertight and pressure tested.

(h) Pump stations shall be watertight.

(i) Pump stations shall have manholes flush with or above finished grade for cleaning and maintenance.

(j) Manhole covers shall be so constructed as to prevent unauthorized entry.

(k) Pumps and pump stations shall be sized to handle peak flows.

(l) An alarm system shall be provided for all pumping stations to warn of pump failure, overflow, or other malfunction.

(3) Maintenance. All persons using a common drain field system shall assure, by contract with maintenance personnel or other equivalent means, that the system will be adequately maintained throughout its useful life. The system so maintained includes, but is not limited to, common drain fields, common sewage tanks, common pumps, common pump stations, common sewers, and all individual tanks connected to the common system.

C. Sewage osmosis. The Electroosmosis System (a proprietary installation process under United States and Canadian patents) may be permitted as an alternative system in clay soils having percolation rates slower than 60 minutes per inch.

Installation shall comply with all applicable requirements for standard systems contained in these regulations as pertain to system location, water table and bedrock separation distances, septic tanks, pumping stations, distribution or drop boxes, and materials.

Conditions for installation and reporting of performance shall be subject to the provisions in item G.

D. Seepage pits.

(1) Seepage pits may be used for disposal of sewage tank effluent only when it can be clearly demonstrated that a standard drainfield system or mound system is not feasible on the particular site in question and when such use is indicated by favorable conditions of soil, ground water level or topography and where such use does not reduce the safety of surrounding ground water supplies. In areas where limestone or any geological formation characterized by similar fault patterns is covered by less than 50 feet of earth, seepage pits shall not be installed. The pit excavation shall terminate at least three feet above the highest known or calculated ground water table. The depth of the excavation shall not exceed 50 percent of the depth of any well casing in the area or ten feet, whichever is least.

(2) When two or more seepage pits are used, a distribution box constructed in accordance with part 7080.0150, subpart 1, item B, subitem (2), shall be used if the inlet inverts of the seepage pits have no more than one foot difference in elevation. If the difference in elevation between the inlet inverts is greater than one foot, the seepage pits shall be connected in series.

(3) Seepage pits, in addition to the general provisions specified in table IV, part 7080.0170, subpart 2, shall be set back not less than the stated minimum distances from the following:

- (a) wells less than 50 feet in depth and not encountering at least ten feet of impervious material, 150 feet;
- (b) any water supply well or buried water suction pipe, 75 feet;
- (c) buildings, 20 feet;
- (d) property lines and buried pipe distributing water under pressure, ten feet;
- (e) other seepage pits, three times the diameter of the largest pit (edge to edge).

(4) Effective soil treatment area of a seepage pit shall be calculated as the sidewall area below the inlet, exclusive of any hardpan, rock, or clay formations. The sidewall area shall be based on the outer diameter of the pit lining plus 12 inches of rock in the annular space.

Required treatment area shall be determined by the percolation test described in part 7080.0100 and from tables II and III, part 7080.0170, subpart 2, with no reduction for increased filter material below or around the pit. In no case shall a seepage pit be installed in soils where the percolation rate of any stratum is faster than one-tenth minute per inch (coarse sand). A percolation test shall be made in each vertical stratum penetrated by the seepage pit, and the weighted average of the results, exclusive of results from soil strata in which the

MINNESOTA RULES 1983

5715

INDIVIDUAL SEWAGE TREATMENT SYSTEMS 7080.0210

percolation rate is slower than 30 minutes per inch, shall be computed and applied to the seepage bed column of table III as indicated.

A minimum of four feet composite depth of porous formation for each installation shall be provided in one or more pits.

All pits shall have an inside diameter of at least five feet.

(5) Construction of all seepage pits shall conform to the following requirements:

(a) To prevent cave-in, the pit shall be precast concrete or lined with brick, stone, or block at least four inches thick, laid in a radial arch to support the pit walls.

(b) The brick, stone, or block shall be laid watertight above the inlet and with open joints below the inlet to provide adequate passage of liquids.

(c) A minimum annular space of 12 inches between the pit lining and excavation wall shall be filled with crushed rock or gravel.

(d) The seepage pit shall be so constructed at the top as to be capable of supporting the overburden of earth and any reasonable load to which it is subjected. Access to the pit shall be provided by means of a manhole or inspection hole equipped with a watertight cover. The seepage pit may terminate in a conventional manhole top, frame, and cover to a point within 12 inches, but no closer than six inches below finished grade. The manhole cover shall be covered with at least six inches of earth. The top of the seepage pit shall be not less than 12 inches below the ground surface. The top shall be provided with an inspection pipe of not less than four-inch diameter extending through the cover to a point flush with finished ground level. The top of the inspection pipe shall be provided with a readily removable watertight cap.

E. Other systems. Where unusual conditions exist, special systems of treatment and disposal other than those specifically mentioned in items A to F, may be employed provided:

(1) reasonable assurance of performance of such system is presented to the permitting authority;

(2) the engineering design of such system is first approved by the permitting authority;

(3) there is no discharge to the ground surface or to surface waters;

(4) treatment and disposal of wastes is in such a manner so as to protect the public health and general welfare;

(5) such systems comply with all applicable requirements of these standards and with all local codes and ordinances.

Subp. 6. Class IV alternatives, holding tanks. Holding tanks:

A. Holding tanks may be allowed only as replacements for existing nonconforming systems or on existing parcels or lots as of the date of the enactment of these standards and only where it can conclusively be shown that a standard, Class I, Class II, or mound system cannot be feasibly installed.

B. A holding tank shall be constructed of the same materials and by the same procedures as those specified for watertight septic tanks.

C. A cleanout pipe of at least six inches diameter shall extend to the ground surface and be provided with seals to prevent odor and to exclude insects and vermin. A manhole of at least 20 inches least dimension shall extend through the cover to a point within 12 inches, but no closer than six inches below finished grade. The manhole cover shall be covered with at least six inches of earth.

D. The tank shall be protected against flotation under high water table conditions. This shall be achieved by weight of tank, earth anchors, or shallow bury depths.

E. For a dwelling the size shall be 1,000 gallons, or 400 gallons times the number of bedrooms, whichever is greater.

MINNESOTA RULES 1983

7080.0210 INDIVIDUAL SEWAGE TREATMENT SYSTEMS

5716

For permanent structures other than dwellings, the capacity shall be based on measured flow rates or estimated flow rates. The tank capacity shall be at least five times the daily flow rate.

F. Holding tanks shall be located: in an area readily accessible to the pump truck under all weather conditions; as specified for septic tanks in table IV, part 7080.0170, subpart 2; where accidental spillage during pumping will not create a nuisance.

G. A contract for disposal and treatment of the sewage wastes shall be maintained by the owner with a pumper, municipality, agency, or firm established for that purpose.

H. Holding tanks shall be monitored to minimize the chance of accidental sewage overflows. Techniques such as visual observation, warning lights, or bells, or regularly scheduled pumping shall be used. For other establishments, a positive warning system shall be installed which allows 25 percent reserve capacity after actuation.

MINNESOTA RULES 1983

VERTICAL SIDEWALL SEPTIC TANK

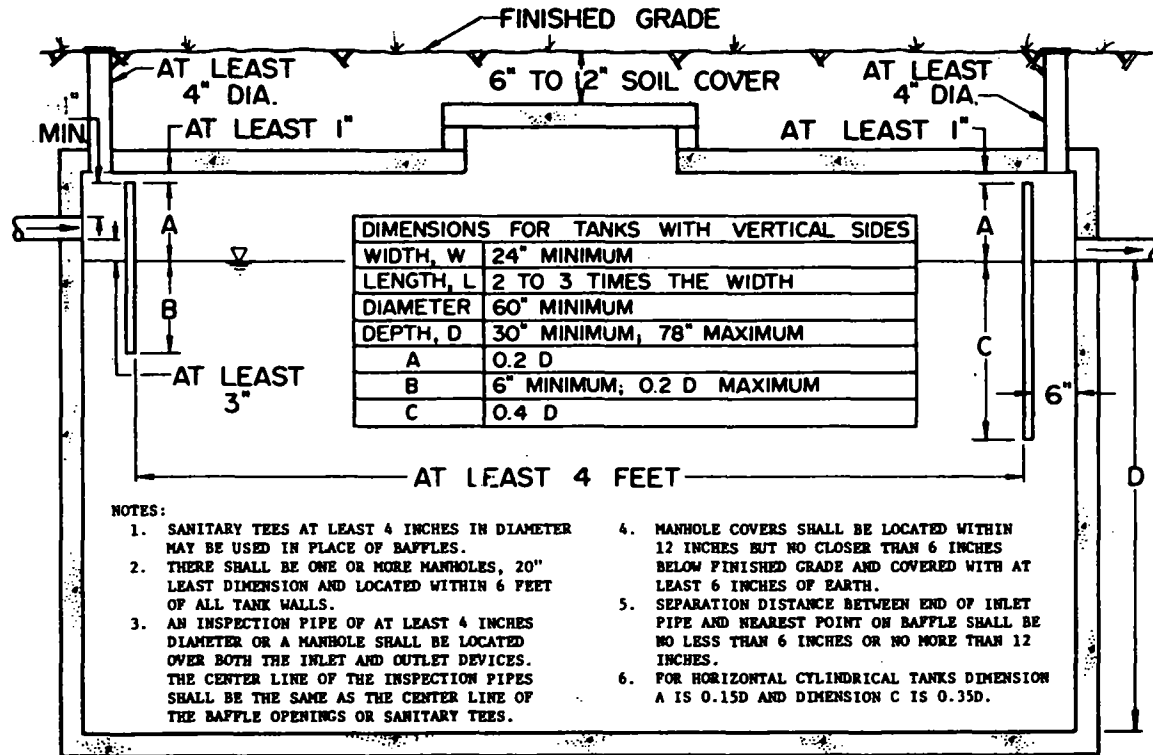

Subp. 7. Figure 1.

5717

INDIVIDUAL SEWAGE TREATMENT SYSTEMS 7080.0210

MINNESOTA RULES 1983

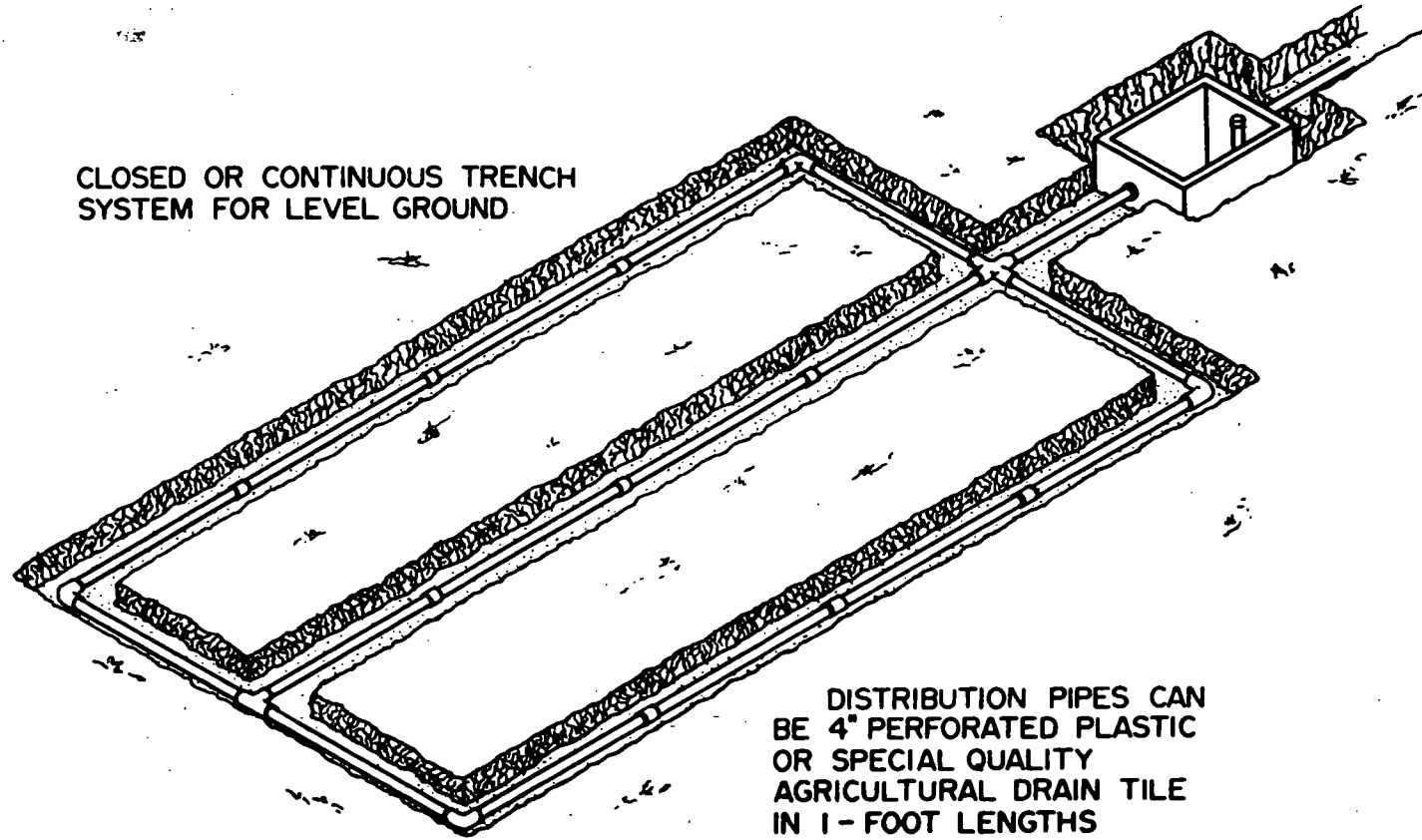

Subp. 8. Figure 2.

MINNESOTA RULES 1983

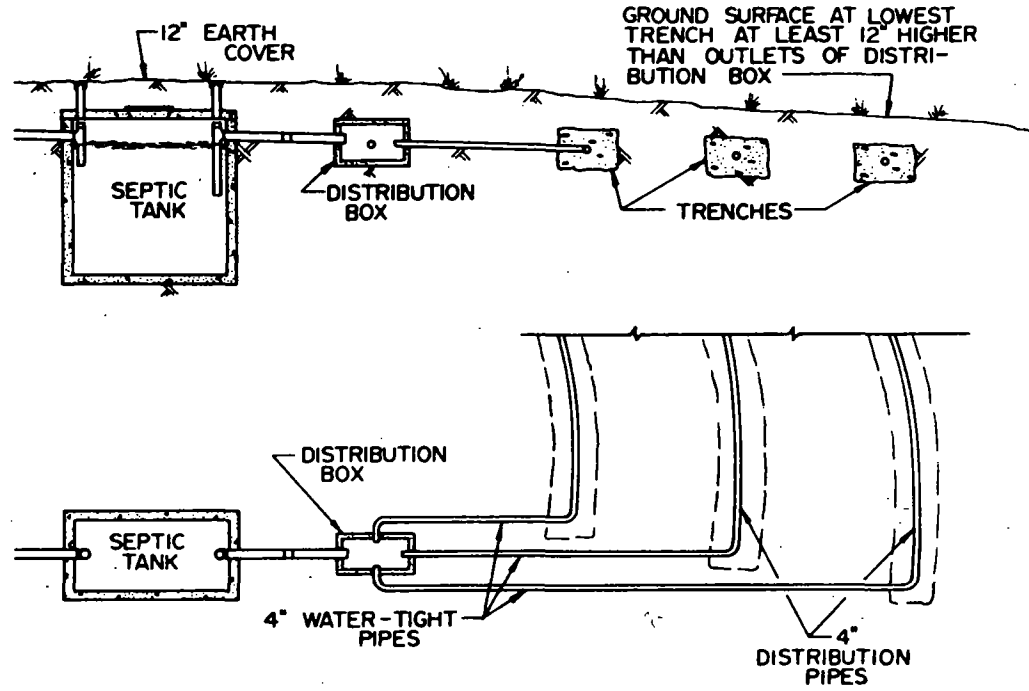

SEWAGE TREATMENT SYSTEM WITH DISTRIBUTION BOX

5719
Subp. 9. Figure 3.
INDIVIDUAL SEWAGE TREATMENT SYSTEMS 7080.0210

MINNESOTA RULES 1983

Subp. 10. Figure 4.

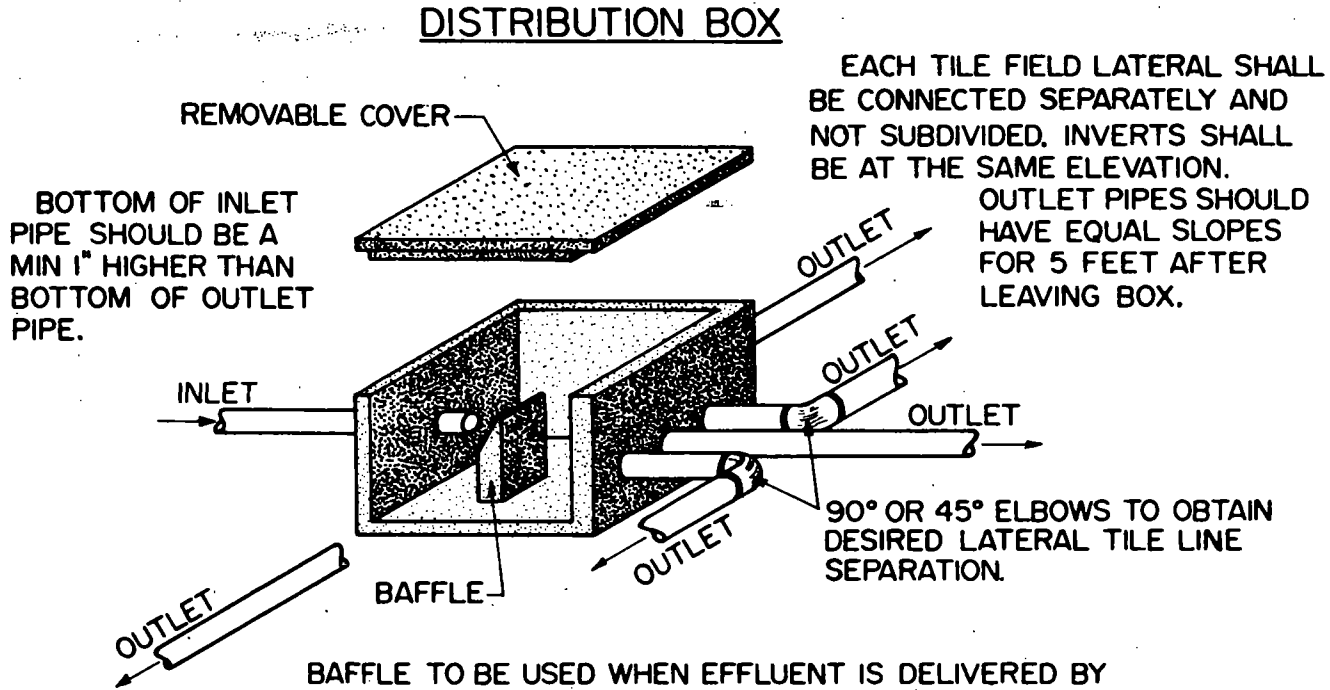

BAFFLE TO BE USED WHEN EFFLUENT IS DELIVERED BY PUMP OR SIPHON, OR THE SLOPE OF THE INLET LINE IS SUCH THAT UNEVEN DISTRIBUTION COULD OCCUR. TOP OF THE BAFFLE AT LEAST LEVEL WITH THE CROWN OF THE INLET PIPE.

MINNESOTA RULES 1983

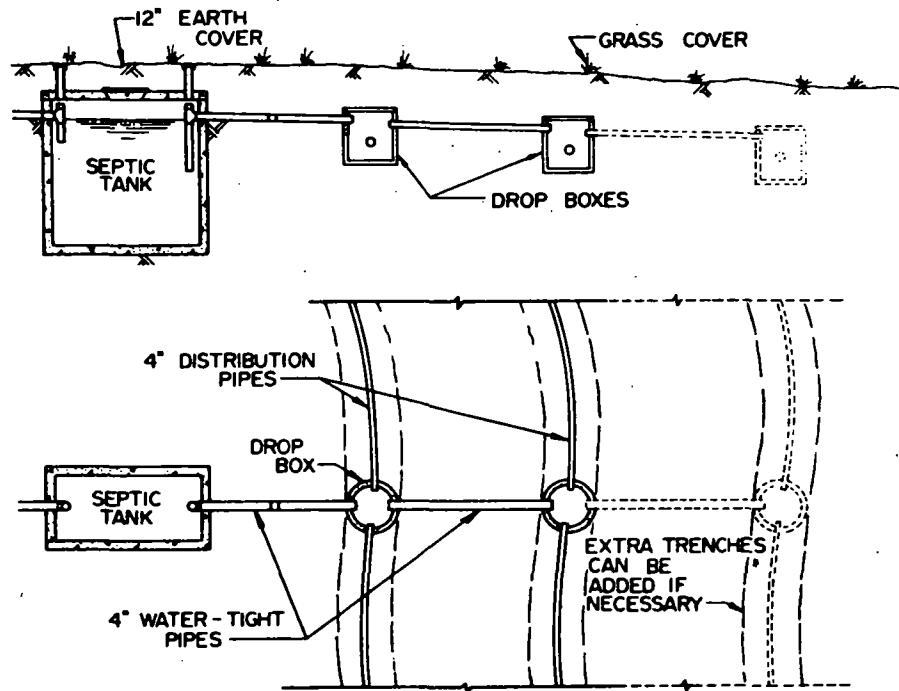

SEWAGE TREATMENT SYSTEM WITH DROP BOXES

Subp. 11. Figure 5.

5721

INDIVIDUAL SEWAGE TREATMENT SYSTEMS 7080.0210

MINNESOTA RULES 1983

Subp. 12. Figure 6.

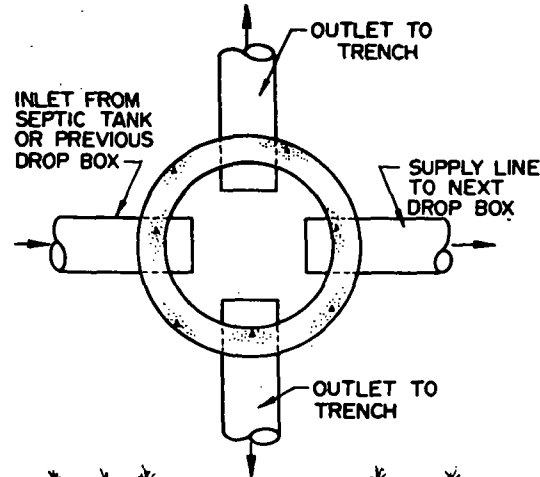

NOTES

1. ALL PIPES SHOULD BE AT LEAST 4-INCH DIAMETER
2. ELEVATION OF INLET AND SUPPLY LINE TO NEXT DROP BOX MAY BE ADJUSTED UP OR DOWN FOR DESIRED EFFLUENT LEVEL IN TRENCH
3. SUGGESTED TRENCH LIQUID LEVEL IS 2" ABOVE TOP OF OUTLET PIPE
4. INVERT OF INLET MUST BE AT LEAST ONE INCH HIGHER THAN INVERT OF SUPPLY PIPE TO NEXT DROP BOX
5. TRENCHES MAY OUTLET ONE SIDE OR BOTH SIDES OF DROP BOX

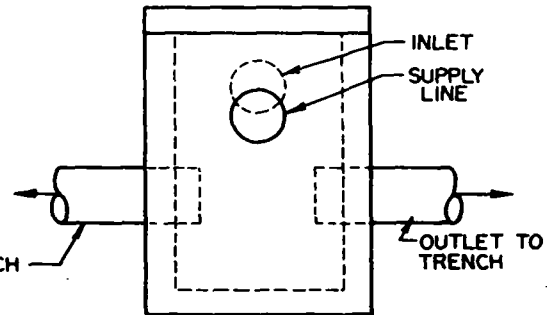
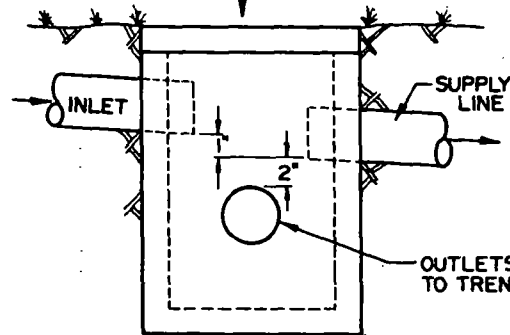

DROP BOX

Subp. 13. Figure 7.

LAYOUT OF PERFORATED PIPE LATERALS FOR PRESSURE DISTRIBUTION

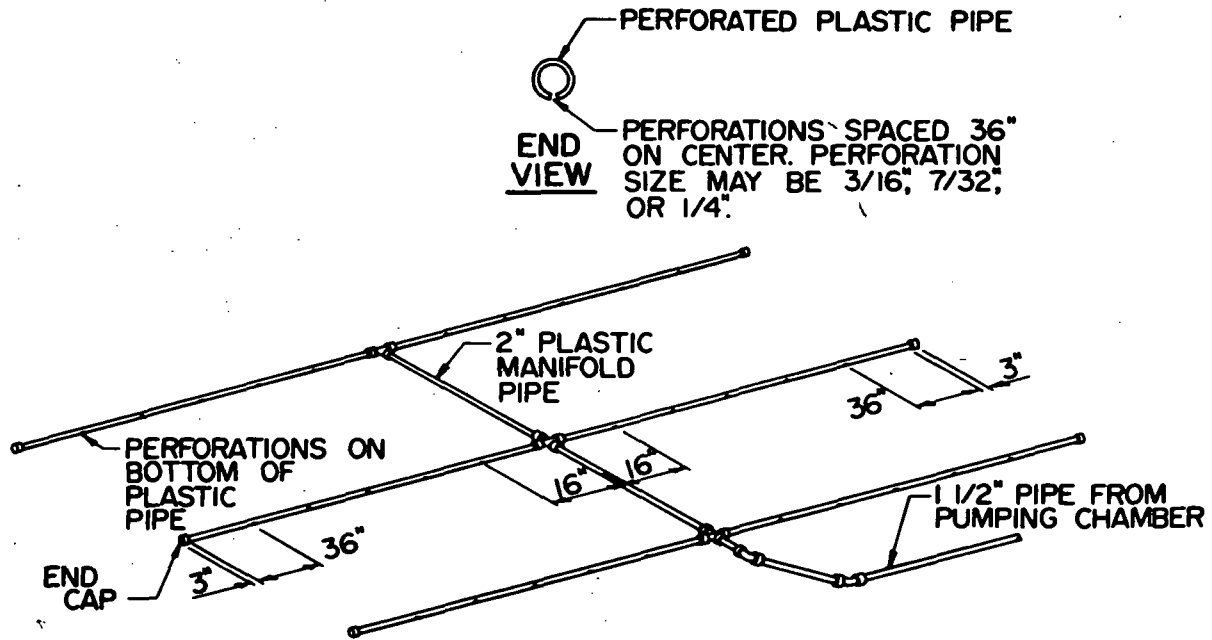

MINNESOTA RULES 1983

Subp. 14. Figure 8.

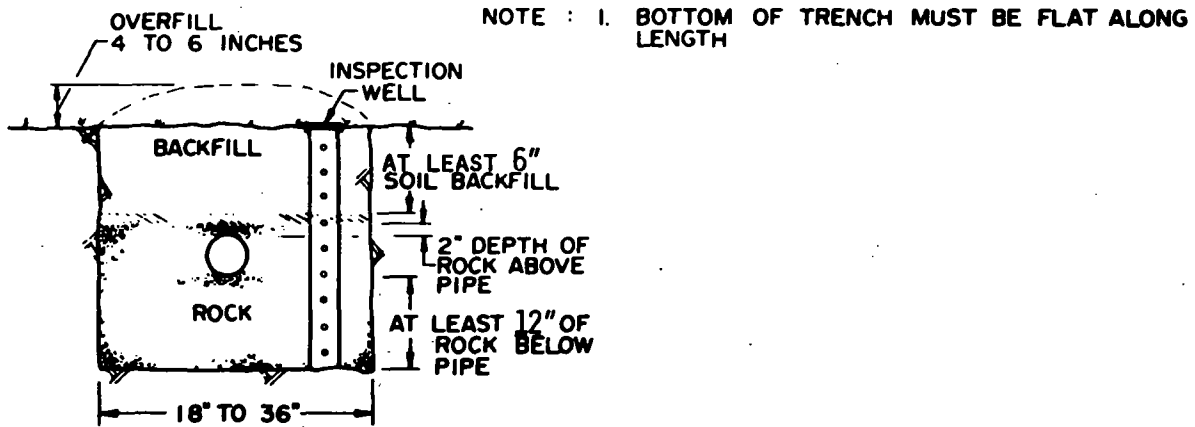
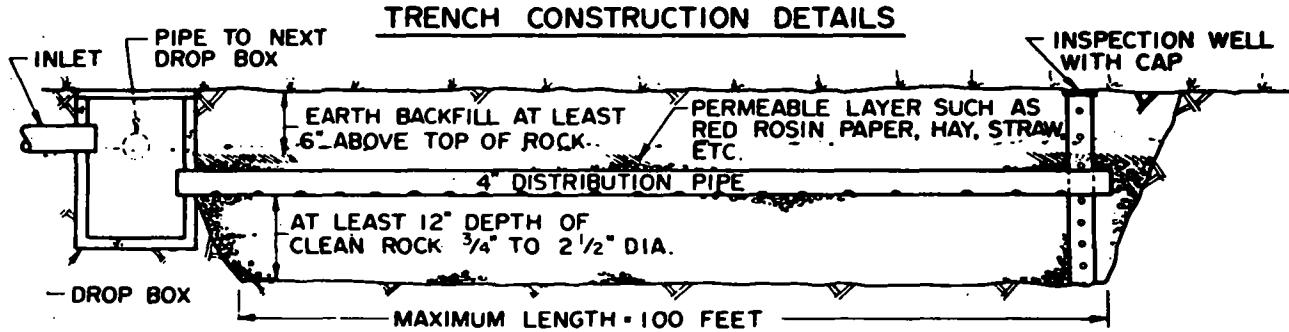

MINNESOTA RULES 1983

5725

INDIVIDUAL SEWAGE TREATMENT SYSTEMS 7080.0210

Subp. 15. Figure 9.

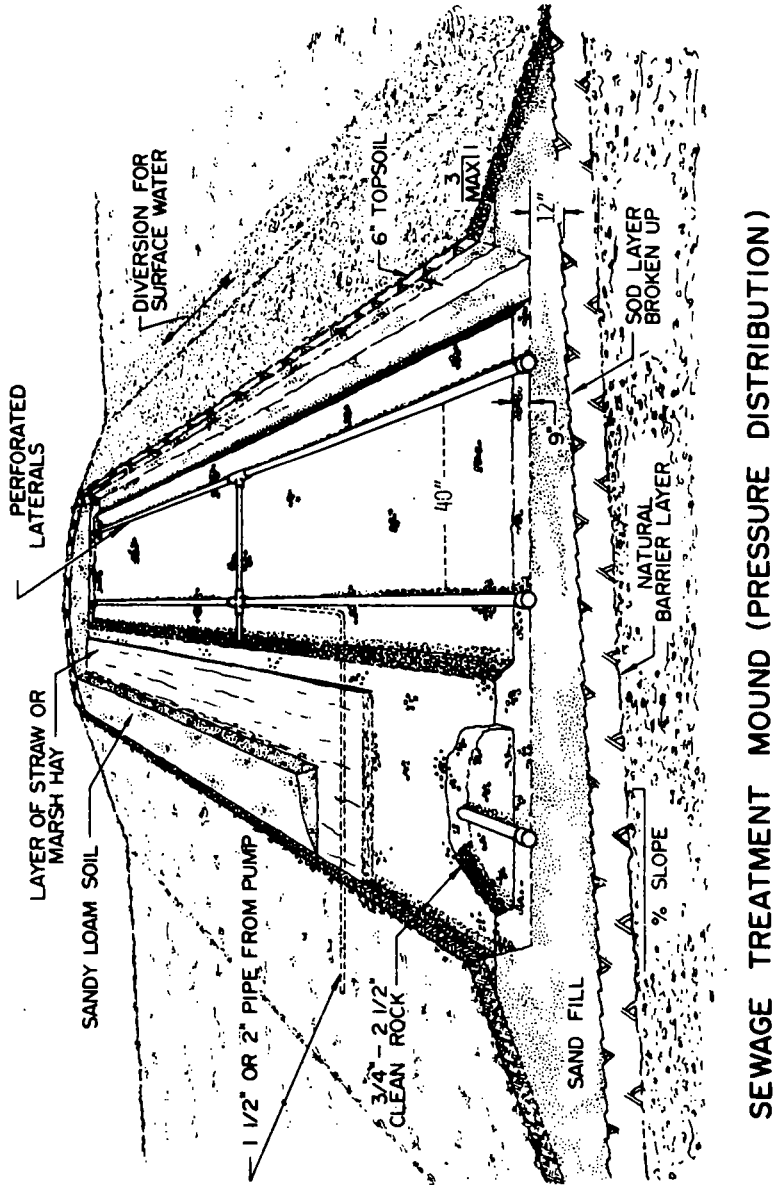

Statutory Authority: *MS s 115.03 subd 1*

MINNESOTA RULES 1983

7080.0220 APPENDIX C.

4715.0400 Quality of materials.

All materials used in any drainage or plumbing system or part thereof shall be free from defects, and no materials which are damaged or defective shall knowingly be installed.

4715.0410 Identification of materials.

All materials must be marked, unless otherwise easily identifiable, so as to provide a visual means of identification as to types, grades, weights, and strengths. The installer shall, as far as possible, position the identification marks so as to provide ease of inspection by the administrative authority.

4715.0420 Standards for plumbing materials.

Subpart 1. Approved materials. A material shall be considered approved if it meets one or more of the standards cited in subpart 3. Materials not listed in subpart 3 shall be used only as provided for in part 4715.0330, or as permitted elsewhere in this code.

Subp. 2. Abbreviations. Abbreviations in subpart 3 refer to the following:

A. ANSI, American National Standards Institute, 10 East 40th Street, New York, New York 10016;

B. ASTM, American Society for Testing and Materials, 1916 Race Street, Philadelphia, Pennsylvania 19103;

C. AWWA, American Water Works Association, 2 Park Avenue, New York City, New York 10016;

D. CS, Commercial Standards available from: Commodity Standards Division, Office of Industry and Commerce, U. S. Department of Commerce, Washington, D. C. 20234;

E. FS, Federal Specifications available from: Federal Supply Service, Standards Division, General Services Administration, Washington, D. C. 20406;

F. NSF, National Sanitation Foundation, Ann Arbor, Michigan 48106;

G. FHA, Federal Housing Authority, Architectural Standards Division, Washington, D. C.

Subp. 3. Standards for plumbing materials.

STANDARDS FOR PLUMBING MATERIALS

DESCRIPTION	ANSI	ASTM	FS	OTHER
1. CAST IRON PIPE & FITTINGS	A21.2			
	A21.6	A-74	WW.P.401C	CS188
1A Cast Iron Pipe & Fittings	A21.8			
Extra Heavy				
1B Cast Iron Pipe Centrifugally				
Cast only and fittings	A21.6	A-74	WW.P.401C	CS188
Service Weight	A21.8			
1C Cast Iron Mechanical	A21.11			
(Gland Type) Pipe	A21.2		WW-P-421a	
	A21.6			
1D Cast Iron Mechanical	A21.8			
(Gland Type) Pipe				
Cement Lined	A21.4			
	A21.2			
	A21.6			
	A21.8			
1E Cast Iron Short Body Water				
Service Fittings (2"-12")	A21.10			AWWA C100
1F Cast Iron Threaded Pipe	A40.5			
1G High Silicon Pipe, Fittings				
Cast Iron				
1H Cast Iron Threaded Fittings	B16.4		WW-P-501	
Black and galvanized 125#				
1J Cast Iron Drainage Fittings	B16.12		WW-P-491	
Black and Galvanized				
1K Hubless Cast Iron Pipe and Fittings (amended 8-31-72)				CISPI Standard 301-69T

MINNESOTA RULES 1983

5727

INDIVIDUAL SEWAGE TREATMENT SYSTEMS 7080.0220

V. SILICA AND EARTH PRODUCTS			
PIPE AND FITTINGS, NON METALLIC			
5A	Asbestos-Cement Pressure Pipe and Fitting	C500 C296	SS-P351
5B	Asbestos-Cement Water Pipe and Fittings	C500	SS-P-351 AWWA C400
5C	Asbestos-Cement Non Pressure Pipe and Fittings	C428	XX-P-331
5D	Asbestos-Cement Perforated Underdrain Pipe and Fittings	C508 C13 C200	
5E	Vitrified Clay Pipe, Standard Strength and Stronger fittings	C278	
5F	Unglazed Clay Pipe, Extra Strength and fittings	C211	
5G	Perforated Clay Pipe and Fittings		
5H	Borosilicate Glass Pipe and Fittings 60 psi		
5J	Non Reinforced Concrete Draintile	C412	AASHO M178
5K	Non Reinforced Concrete Pipe	C14	SS-P-371 AASHO M86
5L	Perforated Concrete Pipe, Underdrainage	C444 C76	
5M	Reinforced Concrete Pipe		SS-P-375
5N	Reinforced and Prestressed Concrete Pipe, Pressure Type and Fittings		
5O	Bituminized Fiber Drain and Sewer Pipe	D1860	SS-P-1540A (Amended 8-31-72)
5P	Perforated Bituminized Fiber Pipe for General Drainage	D2311	SS-P-1540A (Amended 8-31-72)
VI. PLASTIC PIPE AND FITTINGS			
DRAIN, WASTE and VENT			
6A	Acrylonitrile-Butadiene-Styrene (ABS)	D2661	L-P-322a HSF14 FHA-MPS CS270
6B	Polyvinyl Chloride (pvc) Schedule 40 Unthreaded	D2665	L-P-320a NSF14 FHA-MPS CS272
	Schedule 80 can be threaded		
	BUILDING SEWER		
6C	(1) Styrene-Rubber	D2852	L-P-001221 CS228 (Filed 4-5-73)
6C	(2) Polyvinyl Chloride (pvc)	D3033 D3034	FHA-UM-26 WW-P-00380a
	(Amended 4-5-73)		

4715.0530 Building sewers.

The following materials may be used for building sewers:

- A. Cast Iron 1A and 1B and fittings and Hubless Cast Iron 1K.
- B. Cast Iron 1C and 1D with 1E fittings.
- C. Asbestos cement 5A and 5C and fittings laid on a continuous granular bed.
- D. Clay pipe and fittings 5E laid on a continuous granular bed.
- E. Concrete pipe 5K in yard areas and not under permanent streets, laid on a continuous granular bed.
- F. Concrete 5M and 5N and fittings.
- G. Plastic 6A, 6B, 6C(1), 6C(2), and 6C(3) laid a continuous granular bed.
- H. Bituminized-fiber drain and sewer pipe 50, laid on a continuous granular bed.

4715.0700 Tightness.

Joints and connections in the plumbing system shall be gastight and watertight for the pressure required by test, with the exception of those portions of perforated or open joint piping which are installed for the purpose of collecting and conveying ground or seepage water.

4715.0710 Asbestos cement sewer pipe joints.

Joints in asbestos cement pipe shall be made with sleeve couplings of the same composition as the pipe, sealed with rubber rings. Joints between asbestos cement pipe and metal pipe shall be made by means of an adapter coupling caulked as required in part 4715.0740. No adapted coupling shall be used that does not have a center ridge. Pipe must not be able to pass through the coupling.

4715.0720 Bituminized fiber drain pipe joint.

Pipe and bends shall be provided with accurately machined or molded tapered joints, and a taper sleeve coupling shall be provided for each length of pipe and for each bend. The slope of the taper in both pipe and coupling shall be two degrees.

4715.0730 Burned lead joints.

Burned (welded) lead joints shall be fused together to form a uniform weld at least as thick as the lead being joined.

4715.0740 Caulked joints.

Caulked joints for cast-iron bell and spigot soil pipe shall be firmly packed with oakum or hemp and filled with molten lead not less than one inch deep and shall extend not more than one-eighth inch below rim of hub. No paint, varnish, or any other coatings shall be permitted on the jointing material until after the joint has been tested and approved. Lead shall be caulked tight.

4715.0750 Cement mortar joints.

Except for repairs and connections of existing lines constructed with such joints, cement mortar joints are prohibited. Where permitted, cement mortar joints shall be made in the following manner: A layer of jute or hemp shall be inserted into the base of the annular joint space and packed tightly to prevent mortar from entering the interior of the pipe or fitting. Not more than 25 percent of the annular space shall be used for jute or hemp. The remaining space shall be filled in one continuous operation with a thoroughly mixed mortar composed of one part cement and two parts sand, with only sufficient water to make the mixture workable by hand. Additional mortar of the same composition shall then be applied to form a one to one slope with the barrel of the pipe. The bell or hub of the pipe shall be left exposed and when necessary the interior of the pipe shall be swabbed to remove any mortar or other material which may have found its way into such pipe.

4715.0760 Cold joint compound, tar base.

Cold joint compound (tar base) for clay and concrete pipe shall not be water absorbent, and shall bond itself to vitrified clay and concrete pipe. Half of the joint must be packed with oakum, and the remainder with cold tar compound.

4715.0770 Flared joints.

Flared joints for soft copper water tubing shall be made with fittings meeting approved standards. (See part 4715.0420, subpart 3.) The tubing shall be reamed and expanded with proper flaring tools.

4715.0780 Gasket type joints.

Resilient rubber joints for clay or concrete: Flexible joints between lengths of clay or concrete pipe may be made by using approved resilient or rubber materials, both on the spigot end and in the bell end of the pipe.

4715.0790 Hot-poured joints.

Hot-poured compound for clay or concrete sewer pipe, or other materials, shall not be water-absorbent, and when poured against a dry surface shall have a bond of not less than 100 pounds per square inch. All surfaces of the joint shall be clean and dried before pouring. If wet surfaces are unavoidable, a suitable primer shall be applied.

The compound shall not soften sufficiently to destroy the effectiveness of the joint when subjected to a temperature of 160 degrees Fahrenheit nor soluble in

MINNESOTA RULES 1983

5729

INDIVIDUAL SEWAGE TREATMENT SYSTEMS 7080.0220

any of the waste carried by the drainage system. Approximately 25 percent of the joint space at the base of the socket shall be filled with jute or hemp. A pouring collar, rope, or other device shall be used to hold the hot compound when pouring. Each joint shall be poured in one operation until the joint is filled. Joints shall not be tested until one hour after pouring.

4715.0800 Mechanical joints.

Subpart 1. Mechanical joints for cast-iron water pipe. Mechanical joints in cast-iron water pipe shall be made by means of a flanged collar and rubber ring gasket, secured by the use of an adequate number of steel bolts. The rubber sealing ring shall conform to ASA A21-Point 11 requirements.

Subp. 2. Mechanical joints in cast-iron soil pipe. Mechanical joints in cast-iron soil pipe shall be made by means of a preformed molded rubber ring, secured by pulling the pipe and fittings together in such a way as to compress the molded rubber ring in a manner that will assure a gas and water tight joint. The rubber sealing ring shall conform to ASTM 564-65 requirements.

Subp. 3. Mechanical joints in chemical waste pipe. Mechanical joints in chemical waste pipe, of prestressed, low-expansion borosilicate glass pipe and high silicon content cast-iron pipe, shall be joined by means of a stainless steel corrosion resistant clamp assembly, or a clamp assembly utilizing a fiber glass reinforced nylon shell surrounding a sealing sleeve of an elastomeric material containing an approved acid and corrosion resistant seal ring or gasket in such a manner that the sleeve and ring seal or gasket are firmly compressed by the tightening device in order that a gas and water tight joint is provided. The sleeves or bands for this type joint shall be marked with the words "All Stainless," or the recognized abbreviation therefore, and marked with the pipe size for which its use is intended. Fiberglass reinforced shells must bear the manufacturer name. The sleeve must be used as factory assembled. During installation assembly, the pipe or fittings must be inserted into the sleeve so as to be firmly seated against the center rib or shoulder of the gasket, and on all field cut lengths the ends must be as square and smooth as possible.

Subp. 4. Mechanical joints in hubless cast-iron soil pipe. Mechanical joints for hubless cast iron soil pipe and fittings may be made by using a neoprene sleeve and stainless steel retaining band as specified in CISPI standard 301, by using a transition fitting made of elastomeric material (ASTM C 425 and ASTM C 564) and 300 series stainless steel bands and bolts, or using a two part coupling whose housing is fabricated of gray cast iron (ASTM A 48), with a coupling gasket made of neoprene rubber (ASTM C 564), and coupling bolts and nuts made of 18-8 stainless steel.

Subp. 5. Mechanical pipe couplings and fittings. Couplings shall be made with the housing fabricated in two or more parts of malleable iron castings in accordance with Federal Specification QQ-I-666c, Grand 11, or with ASTM A47 or ASTM A339. The coupling gasket shall be molded synthetic rubber, per ASTM D-735-61, Grade No. R615BZ. Coupling bolts shall be oval neck track head type with hexagonal heavy nuts, per ASTM A-183-60, or ASTM A325.

Pipe fittings used with these pipe couplings shall be fabricated or malleable iron castings in accordance with Federal Specifications QQ-I-666c, Grade 11, or with ASTM A47; ductile iron ASTM A339; segweld steel ASTM 53 or A106.

These couplings and fittings may be used above ground, for storm drains and leaders and for water distribution pipe provided exposed parts in contact with water are galvanized.

4715.0810 Plastic joints.

Every joint in plastic piping shall be made with approved fittings by either solvent welded or fusion welded connections or with approved insert fittings and metal clamps and screws of corrosion-resistant material or threaded joints according to accepted standards. All solvent materials must meet approved recognized standards. Expansion and contraction joint materials and dimensions

shall conform to ASTM D 2661 or ASTM D 2665 and shall be of an approved type.

4715.0820 Soldered or brazed joints.

Joints with copper tube with solder joint fittings shall be soldered or brazed. Surfaces to be soldered or brazed shall be thoroughly cleaned. Joints to be soldered shall be properly fluxed with noncorrosive paste type flux. Solder used for joints shall have a nominal composition of 50 percent tin and 50 percent lead, or 95 percent tin and five percent antimony, conforming to ASTM Standard Specification for soft solder metal B32-60T. Joints to be brazed shall be properly fluxed with a flux suitable for brazing material which is used. Brazing material shall conform to ASTM Standard Specification for Brazing Filler Metal B260-52T.

4715.0830 Threaded joints -- screwed joints.

Threaded joints shall conform to American National taper pipe thread, ASA B2.1-1945 or FS GGG-P-351a. All burrs shall be removed. Pipe ends shall be reamed out to size of bore and chips removed. Pipe joint compound shall be used on male threads only.

4715.0840 Wiped joints.

Joints in lead pipe or fittings, or between lead pipe or fittings and brass or copper pipe, ferrules, solder nipples, or traps, shall be full wiped joints. Wiped joints shall have an exposed surface on each side of the joint not less than three-fourths inch, and a minimum thickness at the thickest part of the joint of not less than three-eighths inch. Joints between lead pipe and cast iron, steel, or wrought iron shall be made by means of a caulking ferrule, soldering nipple, or bushing.

4715.0850 Use of joints.

Subpart 1. **Bituminized fiber pipe joints.** Joints in bituminized fiber pipe shall be made as provided for in part 4715.0720.

Subp. 2. **Cast-iron pipe.** Joints in cast iron shall be either caulked or screwed, as provided in parts 4715.0740, 4715.0830, and 4715.0840.

Subp. 3. **Cast-iron soil pipe.** Joints in cast-iron soil pipe may be made by means as provided in part 4715.0740 or 4715.0800, subpart 2.

Subp. 4. **Clay sewer pipe.** Joints in clay sewer pipe, or between such pipe and metal pipe shall be made as provided in parts 4715.0750, 4715.0760, 4715.0780, and 4715.0790.

Subp. 5. **Concrete sewer pipe.** Joints in concrete sewer pipe, or between pipe and metal pipe, shall be made by means as provided in parts 4715.0750, 4715.0760, 4715.0780, and 4715.0790.

Subp. 6. **Copper water tube.** Joints in copper water tubing shall be made either by the appropriate use of approved brass or wrought copper water fittings properly soldered or brazed, or by means of approved flared fittings as provided in part 4715.0770.

Subp. 7. **Lead to cast iron, wrought iron and steel.** Joints between lead and cast iron, wrought iron, or steel shall be made by means of wiped joints to a caulking ferrule, soldering nipple, or bushing as provided in part 4715.0840.

Subp. 8. **Plastic pipe joints.** Joints in plastic pipe or between plastic and cast iron, steel, brass, or copper pipe shall be made as provided in part 4715.0810.

Subp. 9. **Threaded pipe to cast iron.** Every joint between wrought iron, steel, brass, copper, and cast-iron pipe shall be either caulked or threaded joints as provided in parts 4715.0740, 4715.0830, and 4715.0840 and shall be made with approved adapter fittings.

4715.0860 Special joints.

MINNESOTA RULES 1983

5731

INDIVIDUAL SEWAGE TREATMENT SYSTEMS 7080.0220

Subpart 1. **Bituminized fiber to other types of pipe.** When connecting bituminized fiber pipe to other types of materials, only approved types of fittings and adaptors designed for the specific transition intended shall be used.

Subp. 2. **Cast-iron to copper tube.** Caulked joints between copper tubing and cast-iron soil pipe shall be made by means of brass or copper ferrules or other approved adapter fittings.

Subp. 3. **Copper tubing to threaded pipe joints.** Joints from copper tubing to threaded pipe shall be made by the use of brass or copper adapter fittings. The joint between the copper pipe and fitting shall be properly soldered, brazed, or flared.

Subp. 4. **Expansion joints.** Every expansion joint shall be of an approved type and the material used in its manufacture shall be compatible with the type of piping in which it is installed. Every expansion joint, other than an expansion loop, shall be accessible. (Also see part 4715.2770)

Subp. 5. **Slip joints.** In drainage piping, slip joints shall be used only on the inlet side of the trap or in the trap seal. Every slip joint shall be made using approved packings of gasket material or approved ground joint brass compression rings. Ground faced connections which allow adjustments of tubing but provide a durable rigid joint when made up shall not be considered as a slip joint.

Subp. 6. **Transition couplings.** A transition coupling is one which is to be used when pipes made of different materials are to be joined. A transition coupling may be made of elastomeric materials (ASTM C 425 and ASTM C 564) and 300 series stainless steel bands and bolts. Any transition coupling joining plastic to plastic, copper to copper, or galvanized to galvanized, must be approved by the administrative authority.

4715.0870 Flanged fixture connections.

Fixture connections between drainage pipes and water closets, pedestal urinals, and earthenware trap standards shall be made by means of brass, plastic, or iron flanges, caulked, soldered, solvent welded, or screwed to the drainage pipe. The connection shall be bolted, with an approved gasket, washer, or setting compound between the earthenware and the connection. Floor flanges of other equivalent materials may be used when approved by the administrative authority.

The bottom of the floor flange shall be set on the top of the finished floor or on a structurally firm base. Closet bends or stubs must be cut off so as to present a smooth surface, even with the top of the closet flange. Use of commercial putty or plastic as fixture setting compound is prohibited.

4715.0880 Prohibited joints and connections.

See part 4715.2420.

4715.0890 Increasesers and reducers.

Brass or cast-iron body cleanouts shall not be used as a reducer or adapter from cast-iron soil pipe to steel or wrought iron pipe. Where different sizes of pipe or pipes and fittings are to be connected, the proper size increasesers, reducers, or reducing fittings shall be used between the two sizes. Hexagon screwed bushings shall not be used in drainage piping.

4715.1000 Location.

There shall be at least two cleanouts in the building drain, one at or near the base of the stack and one near the connection between the building drain and the building sewer. The cleanout at the outside wall may be inside or outside the building, and shall be made with a full "Y" branch fitting and shall extend at least two inches above grade or finished floor, except that the administrative authority may grant permission to use a flush cover in traffic areas.

MINNESOTA RULES 1983

7080.0220 INDIVIDUAL SEWAGE TREATMENT SYSTEMS

5732

A cleanout which is easily accessible shall be provided at or near the foot of each vertical soil or waste stack.

Each horizontal branch drain pipe shall be provided with a cleanout at its upper terminal, except that a fixture trap or a fixture with an integral trap, readily removable without disturbing concealed piping, may be accepted as a cleanout equivalent for this purpose.

4715.1010 Size of cleanouts.

The cleanout shall be of the same nominal size as the pipes they serve up to four inches in diameter and not less than four inches for larger piping.

The distance between cleanouts in horizontal piping shall not exceed 50 feet for three inch or less in size and not over 100 feet for four inch and over in size.

4715.1020 Cleanout materials.

The bodies of cleanout ferrules shall be made to standard pipe sizes, conform in thickness to that required for pipes and fittings of the same material and extend not less than one-fourth inch above the hub. The cleanout cover or plug shall be of brass, cast iron, or approved plastic and be provided with a raised nut or recessed socket for removal.

Neoprene or nardel rubber with a plastic disc and a single stainless steel (300 series) band may be used for a cleanout cover provided that it is exposed and readily accessible. Cleanout covers shall conform to specifications and details as shown in part 4715.4000, subpart 1.

4715.1030 Cleanouts to be accessible.

Each cleanout, unless installed under an approved cover plate or left flush with the finished floor, shall be at least two inches above grade, readily accessible, and shall not be covered with cement, plaster, or other permanent finish material. Where a soil stack cleanout is located within ten feet of where the building drain leaves the building, the cleanout at the outside wall may be eliminated.

4715.2300 Load on drainage piping.

Subpart 1. **Computation of drain load.** The load on drainage system piping shall be computed in terms of drainage fixture units in accordance with subparts 2 and 3, except the administrative authority may allow variations where it is shown by a hydraulic analysis of the piping system, submitted to the administrative authority, that such variation would result in a more desirable flow rate in the piping system.

Subp. 2. **Values for continuous flow.** Fixture unit values for continuous or semicontinuous flow into the drainage system, such as from a pump, sump ejector, air conditioning equipment, or similar device shall be computed on the basis of one fixture unit for each gallon per minute flow.

Subp. 3. Table of fixture unit values for various plumbing fixtures.

Type of Fixture	Fixture Unit Value	Minimum Fixture Trap and Drain Size
Clothes washer (domestic use)	2	1-1/2
Clothes washer (public use in groups of 3 or more)	6 each	
Bath tub with or without shower	2	1-1/2
Bidet	2	1-1/2
Dental unit or cuspidor	1	1-1/4
Drinking fountain	1	1-1/4
Dishwasher, domestic	2	1-1/2
Dishwasher, commercial	4	2

MINNESOTA RULES 1983

5733

INDIVIDUAL SEWAGE TREATMENT SYSTEMS 7080.0220

Floor drain with 2 inch waste	2	2
Floor drain with 3 inch waste	3	3
Floor drain with 4 inch waste	4	4
Lavatory	1	1-1/4
Laundry tray (1 or 2 compartment)	2	1-1/2
Shower stall, domestic	2	1-1/2
Shower (gang) per head	1	
SINKS:		
Combination, sink and tray (with disposal unit)	3	1-1/2
Combination, sink and tray (with one trap)	2	1-1/2
Domestic	2	1-1/2
Domestic, with disposal unit	2	1-1/2
Surgeons	3	1-1/2
Laboratory	1	1-1/2
Flushrim or bedpan washer	6	3
Service	3	2
Pot or scullery	4	2
Soda fountain	2	1-1/2
Commercial, flat rim, bar, or counter	3	1-1/2
Wash, circular, or multiple (per set of faucets)	2	1-1/2
URINAL pedestal, wall hung, with 3 inch trap (blowout and syphon jet)		
Wall hung with 2 inch trap	6	3
Wall hung with 2 inch trap	3	2
Wall hung with 1-1/2 inch trap	2	1-1/2
Trough (per 6 foot section)	2	1-1/2
Stall	3	2
WATER CLOSET		
Unlisted Fixture or Trap Size	6	3
1-1/4 inch	1	
1-1/2 inch	2	
2 inch	3	
2-1/2 inch	4	
3 inch	5	
4 inch	6	

4715.2310 Selecting size of drainage piping.

Subpart 1. **Determination of size.** Pipe sizes shall be determined from subparts 2 and 3 on the basis of drainage load computed from part 4715.2300, subparts 2 and 3.

Subp. 2. **Maximum loads for horizontal drains in fixture units.**

Diameter of Drain (inches)	Horizontal Fixture Branch* 1/4 in/ft. (f.u.)	Building Sewer, Building Drain and Building Drain Branches--from Stacks****			
		Slope			
		1/16 in/ft. (f.u.)	1/8 in/ft. (f.u.)	1/4 in/ft. (f.u.)	1/2 in/ft. (f.u.)
1-1/4	1				
1-1/2	3				
2	6			21	26
2-1/2	12			24	31

MINNESOTA RULES 1983

7080.0220 INDIVIDUAL SEWAGE TREATMENT SYSTEMS

5734

3**	32***		36***	42***	50***
4	160		180	216	250
5	360		390	480	575
6	620		700	840	1,000
8	--	1,400	1,600	1,920	2,300
10	--	2,500	2,900	3,500	4,200
12	--	3,900	4,600	5,600	6,700
15	--	7,000	8,300	10,000	12,000

*Includes Horizontal Branches of the Building Drain.

**No water closet shall discharge into a drain less than 3 inch.

***Not over 2 Water Closets.

****Every building drain that receives the discharge of (3) or more water closets, shall not be less than 4 inch in diameter.

*****No building sewer shall be less than 4 inches in diameter.

Subp. 3. **Maximum loads for soil and waste stacks in fixture units.**

Diameter of Stack	Stacks of not more than 3 stories or Branch Intervals	Stacks of more than 3 stories or Branch Intervals	Total at One Story or Branch Interval
1-1/4*	2	2	1
1-1/2*	4	4	2
2*	9	18	6
2-1/2*	20	42	9
3	36***	72***	24**
4	240	500	90
5	540	1,100	200
6	960	1,900	350
8	---	3,600	600
10	---	5,600	1,000
12	---	8,400	1,500

*No water closets permitted.

**Not over 2 water closets permitted.

***Not over 6 water closets permitted, and not over 6 branch intervals on a 3 inch soil stack.

4715.2320 Minimum size of soil and waste stacks.

No soil or waste stack shall be smaller than the largest horizontal branch connected thereto except that a four by three water closet connection shall not be considered as a reduction in pipe size.

4715.2330 Minimum size of stack vent or vent stack.

Any structure in which a building drain is installed shall have at least one stack vent or vent stack carried full size through the roof not less than three inches in diameter. Where one or more soil stacks are required to extend through the roof undiminished in size they should be the stack or stacks most remote from the location where the building drain leaves the building. When a soil or waste stack receives the discharge of fixtures located on two or more floors, and the uppermost fixture is located three or more floors above the building drain, such stack and stack vent shall continue undiminished in size through the roof.

4715.2340 Provision for future fixtures.

When provision is made for future installation of fixtures, those provided for shall be considered in determining the required sizes of drain and vent pipes. Construction to provide for such future installations shall be terminated with a plugged fitting or fittings.

MINNESOTA RULES 1983

5735

INDIVIDUAL SEWAGE TREATMENT SYSTEMS 7080.0220

4715.2350 Minimum size of underground drainage piping.

No portion of the drainage system installed underground shall be less than two inches in diameter.

4715.2360 Sizing of offsets on drainage piping.

Subpart 1. **Offsets of 45 degrees or less.** An offset in a vertical stack with a change of direction of 45 degrees or less from the vertical may be sized as a straight vertical stack.

Subp. 2. **Offsets of more than 45 degrees.** A stack with an offset of more than 45 degrees from the vertical shall be sized as follows:

A. The portion of the stack above the offset shall be sized as for a regular stack based on the total number of fixture units above the offset.

B. The offset shall be sized as for a building drain branch, part 4715.2310, subpart 2.

C. The portion of the stack below the offset shall be sized at least as large as the offset.

Subp. 3. **Above highest branch.** An offset above the highest branch connection is an offset in the stack vent and shall be considered only as it affects the developed length of the vent.

Subp. 4. **Below lowest branch.** In the case of an offset in a soil or waste stack below the lowest branch connection, there shall be no change in diameter required if the offset is made at an angle of not greater than 45 degrees from the vertical.

If such offset is made at an angle of greater than 45 degrees from the vertical, the required diameter of the offset and the stack below it shall be sized as for a building drain. (Part 4715.2310, subpart 2.)

4715.2370 Fixture connections to an offset of more than 45 degrees or at base of stack.

When stacks in buildings of five or more stories in height receive the discharge of fixtures four or more stories above the offset, no fixtures on the floor at which the offset occurs shall be connected to the stack within eight feet of the base of the offset measured vertically or horizontally. Said fixtures may also be connected into vertical section of the stack more than two feet below the offset. Fixture connections to horizontal piping at the bases of such stacks shall be made in the same manner, or at a point acceptable to the administrative authority.

4715.2400 Pitch or horizontal drainage piping.

Horizontal drainage piping shall be installed in uniform alignment at uniform slopes in accordance with the following requirements and in no case at a slope which will produce a computed velocity of less than two feet per second, unless otherwise permitted by the administrative authority, based on hydraulic analysis of the piping system.

Size of Piping	Minimum Slope
Less than 3 inches	1/4 inch per foot
3 inches to 6 inches	1/8 inch per foot
8 inches and over	1/16 inch per foot

4715.2410 Change in direction.

Changes in direction in drainage piping shall be made by the appropriate use of 45 degree wyes, long or short sweep quarter bends, sixth, eighth, or sixteenth bends, or by combination of these or equivalent fittings. Single and double sanitary tees, quarter bends, and long turn ells may be used in drainage lines only where the direction of the flow is from the horizontal to the vertical. Short sweep bends or long turn ells three inch or larger in diameter may be used in soil or waste lines where the change in direction of flow is from either the horizontal to the vertical or from the vertical to the horizontal.

4715.2420 Prohibited fittings and connections.

Subpart 1. **General prohibitions.** No fittings having a hub in the direction opposite to flow, or straight tee branch shall be used as a drainage fitting. No fitting or connection which has an enlargement chamber or recess with a ledge or shoulder, or reduction in pipe area shall be used. No drainage or vent piping shall be drilled, tapped, or welded unless otherwise permitted by the administrative authority. Fittings used for back-to-back, wall outlet, blowout type water closet bowls shall have a baffle plate or other device to prevent the waste water from one water closet from entering the opposite water closet. No fixture connection shall be made to a closet bend. No running threads, bands, or saddles shall be used. The short pattern fitting in a horizontal position is prohibited in underground work.

Subp. 2. **Heel or side-inlet bends.** A heel or side-inlet quarter bend shall not be used as a vent when the inlet is placed in a horizontal position or any similar arrangement of pipe or fittings producing a similar effect.

Subp. 3. **Obstruction to flow.** No fitting, connection, device, or method of installation which obstructs or retards the flow of water, wastes, sewage, or air in the drainage or venting system in an amount greater than the normal frictional resistance to flow shall be used unless it is indicated as acceptable to this code by having a desirable and acceptable function and as of ultimate benefit to the proper and continuing functioning of the plumbing system. The enlargement of a three-inch closet bend or stub to four inches shall not be considered an obstruction, provided the horizontal flow line or insert is continuous without forming a ledge.

Subp. 4. **Dead ends.** In the installation of a drainage system, dead ends shall be avoided except where necessary to extend piping for a cleanout so as to be accessible.

4715.2430 Building drains below building sewer.

Building drains which cannot be discharged to the sewer by gravity flow shall discharge into an approved watertight, gastight vented sump or receiving tank, so located as to receive the sewage or wastes by gravity. From such sump or receiving tank the sewage or other liquid wastes shall be lifted and discharged into the building gravity drain by approved automatic pumping equipment. The system or drainage piping entering such sump shall be installed and vented as required in this section for a gravity system.

4715.2440 Design of sumps.

Subpart 1. **Construction.** Sumps and receiving tanks shall be constructed of poured concrete, metal, or other approved materials. If constructed of poured concrete, the walls and bottom shall be adequately reinforced and designed to acceptable standards. Metal sumps or tanks shall be of such thickness as to serve their intended purpose and shall be treated internally and externally to resist corrosion.

Subp. 2. **Discharge line.** The discharge line from such pumping equipment shall be provided with an accessible back-water valve and gate valve, and if the gravity drainage line to which such discharge line connects is horizontal, the method of connection shall be from the top through a wye branch fitting. The minimum size of any pump or discharge pipe from a sump having a water closet connected thereto shall not be less than two inches.

Subp. 3. **Sumps for buildings.** Building drains or building sewers receiving discharge from any pumping equipment shall be adequately sized to prevent overloading. In all buildings, other than single- and two-family dwellings, should three or more water closets discharge into the sump, duplicate pumping equipment shall be installed.

MINNESOTA RULES 1983

5737

INDIVIDUAL SEWAGE TREATMENT SYSTEMS 7080.0220

Subp. 4. **Covers.** Sumps and receiving tanks shall be provided with gastight metal covers, except that float control or switch rods shall operate without binding. Such cover shall be of a bolt and gasket type or equivalent manhole opening to permit access for inspection, repairs, and cleaning.

Subp. 5. **Single-family dwellings.** In single-family dwellings the minimum capacity of a sump shall be 18 gallons.

Subp. 6. **Sump vent.** The top of the sump tank shall be provided with a vent pipe which shall extend separately through the roof, or may be combined with other vent pipes. Such vent shall be large enough to maintain atmospheric pressure within the sump under all normal operating conditions and in no case less than in accordance with the number of fixture units discharging into the sump. When the foregoing requirements are met and the vent, after leaving the sump, is combined with vents from fixtures discharging into the sump, the size of the combined vent need not exceed that required for the total number of fixtures discharging into the sump. No vent from an air operated sewage ejector shall combine with other vents.

Subp. 7. **Clear water sumps.** Sumps and receiving tanks which receive only clear water drainage, and from which sewage is excluded, need not be airtight or vented.

4715.2800 Inspections.

New plumbing systems and parts of existing systems which have been altered, extended, or repaired shall be inspected and tested by the proper administrative authority to ensure compliance with all the requirements of this code and the installation and construction of the system in accordance with the approved plan and the permit, except that testing may be waived for work which does not include addition to, replacement, alteration, or relocation of any water supply, drainage, or vent piping.

All the piping shall be tested and after the plumbing fixtures have been set, and before the system is put into use, the system shall be given a final inspection and test by the proper administrative authority.

4715.2810 Notifications.

It shall be the duty of the plumbing contractor to notify the proper administrative authority and the owner or his authorized agent orally, by telephone, or in writing, not less than eight working hours between the hours of 8:00 a.m. and 4:00 p.m. before the work is to be inspected or tested. It shall be the duty of the plumbing contractor to make sure that the work will stand the test prescribed before giving the above notification. If the proper administrative authority finds that the work will not stand the test, the plumbing contractor shall be required to renotify as above. If the proper administrative authority does not appear for an inspection within 24 hours of the time set, excluding Saturdays, Sundays, and holidays, the inspection or test shall be deemed to have been made, and the plumbing contractor is required to file an affidavit with the proper administrative authority that the work was installed in accordance with the code, the approved plans and permit, and that it was free from defects and that the required tests had been made and the system found free from leaks; also whether the owner or his authorized agent was present when such inspection or test was made.

4715.2820 Method of testing.

Subpart 1. **Testing.** The air tests shall be applied to the plumbing drainage system in its entirety or in sections. Sections which are found satisfactory need not be retested after completion of the entire system unless considered necessary by the proper administrative authority.

Subp. 2. **Rough plumbing.** Except for outside leaders and perforated or open drain tile, the piping of plumbing drainage and venting systems shall be air tested upon completion of the rough piping. The air test shall be made by attaching the air compressor or testing apparatus to any suitable opening and

closing all other inlets and outlets to the system by means of proper testing plugs. Plaster of paris shall not be used in roof terminals. Air shall be forced into the system until there is a uniform pressure of five pounds per square inch on the portion of the system being tested. The pressure shall remain constant for 15 minutes without the addition of air.

Subp. 3. **Finished plumbing.** After the plumbing fixtures have been set and their traps filled with water, their connections shall be tested and proven gas and water tight by plugging the stack openings on the roof and the building drain where it leaves the building, and air introduced into the system equal to the pressure of a one inch water column. Such pressure shall remain constant for the period of inspection without the introduction of additional air.

Subp. 4. **Conductor pipes.** Conductor pipes and their roof connections inside the building shall be tested with air. (See subpart 2)

Subp. 5. **Test of water distribution system.** Upon the completion of a section or of the entire water-distribution system, it shall be tested and proved tight under water not less than the maximum working pressure under which it is to be used. The water used for the test shall be obtained from a potable source of water.

Subp. 6. **Material and labor for tests.** The equipment, material, power, and labor necessary for the inspection and test shall be furnished by the plumbing contractor.

4715.2830 Covering of work.

No building drainage or plumbing system or part thereof shall be covered until it has been inspected, tested, and approved as herein prescribed.

If any building drainage or plumbing system or part thereof is covered before being regularly inspected, tested, and approved, as herein prescribed, it shall be uncovered upon the direction of the proper administrative authority.

4715.2840 Defective work.

If the inspection or test shows defects, such defective work or material shall be replaced and the inspection and test repeated.

All installed fixtures found defective or in an insanitary condition shall be repaired, replaced, or removed upon written notice from the proper administrative authorities.

4715.2850 Air test of defective plumbing.

The air test shall be used in testing the sanitary condition of the drainage or plumbing system of all buildings where there is reason to believe that it has become defective. In buildings condemned by the proper administrative authority because of insanitary conditions of the plumbing system, the alterations in such system shall not be considered as repairs, but as new plumbing.

Where buildings are moved from one location to another, or raised for foundations, or where part of the plumbing system has been damaged by fire, storm, or other means, a final air test shall be applied and shall hold tight, if in the opinion of the administrative authority it is warranted in order to assure a sanitary plumbing system.

4715.2860 Maintenance.

The plumbing system of every building shall be maintained in a sanitary and safe operating condition.

4715.2870 Disinfection of water piping.

See part 4715.2250.

4715.2880 Building sewer.

The building sewer shall be inspected by the proper administrative authority to ensure compliance with the provisions of the code.

4715.2890 Certificate of approval.

Upon the satisfactory completion and final inspection of the plumbing system, a certificate of approval shall be issued by the proper administrative

MINNESOTA RULES 1983

5739

INDIVIDUAL SEWAGE TREATMENT SYSTEMS 7080.0240

authority.

Statutory Authority: *MS s 115.03 subd 1*

7080.0230 APPENDIX D.

4725.2000 Distance from pollution or contamination sources.

Subpart 1. **Distances.** A well shall be at least:

D. Fifty feet from a buried sewer, septic tank, subsurface disposal field, grave, animal or poultry yard or building, privy, or other contaminants that may drain into the soil.

E. Twenty feet from a buried sewer constructed of cast iron pipe or plastic pipe (ASTM 2665 for polyvinyl chloride pipe or ASTM 2661 for acrylonitrile-butadiene-styrene pipe, as prescribed in the Minnesota Plumbing Code, part 4715.0420, subpart 3) with tested watertight joints, a pit or unfilled space below ground surface, a sump or a petroleum storage tank except that a well may be drilled closer than 20 feet to an approved basement, but no closer than as provided in part 4725.2100. A community public water supply well shall be isolated at least 50 feet from any source of contamination.

"Sump" means a watertight tank which receives sewage or liquid waste and which is located below the normal grade of the gravity system and must be emptied by mechanical means.

F. Wells with casings less than 50 feet in depth and not encountering at least ten feet of impervious material shall be located at least 150 feet from cesspools, leaching pits, or dry wells and at least 100 feet from a subsurface disposal field, manure storage pile, or similar source of contamination.

For example, a manure storage pile, would be considered as a potential source of contamination to the well; however, the presence of animals in open pasture in an area would not necessarily concentrate contaminants to the degree that would cause contamination to enter the groundwater.

Statutory Authority: *MS s 115.03 subd 1*

7080.0240 APPENDIX E.

6105.0120 Sanitary standards.

The sanitary provision standards set forth in part 6120.1300 shall apply to wild, scenic, and recreational river land use districts. However, the provisions of part 6120.1300, subpart 3, item D are superseded by the following setback provisions for septic tank and soil adsorption systems:

Setback from the Normal
High Water Mark

Wild river	150 feet
Scenic river	100 feet
Recreational river	75 feet
Tributaries	75 feet

6120.1300 Sanitary provisions.

Subp. 3. **Sewage and waste disposal.** Any premises used for human occupancy shall be provided with an adequate method of sewage disposal to be maintained in accordance with acceptable practices.

D. **Septic tank and soil absorption systems shall be set back from the normal high water mark in accordance with class of public waters:**

MINNESOTA RULES 1983

7080.0240 INDIVIDUAL SEWAGE TREATMENT SYSTEMS

5740

- (1) on natural environment lakes and streams, at least 150 feet;
- (2) on recreational development lakes, at least 75 feet; and
- (3) on general development lakes and streams, at least 50 feet.

6120.3400 Sanitary provisions.

Subp. 3. **Sewage and waste disposal.** Any premises used for human occupancy shall be provided with an adequate method of sewage disposal to be maintained in accordance with acceptable practices.

D. Septic tank and soil absorption systems shall be set back from the ordinary high water mark in accordance with the class of public waters:

- (1) on natural environment waters, at least 150 feet;
- (2) on recreational development waters, at least 75 feet; and
- (3) on general development waters, at least 50 feet.

Statutory Authority: *MS s 115.03 subd 1*