

CHAPTER 4715
MINNESOTA PLUMBING BOARD
PLUMBING CODE

4715.0100	DEFINITIONS.	4715.0880	PROHIBITED JOINTS AND CONNECTIONS.
4715.0200	BASIC PLUMBING PRINCIPLES.	4715.0890	INCREASERS AND REDUCERS.
"4715.0200	BASIC PLUMBING PRINCIPLES.		TRAPS AND CLEANOUTS
4715.0300	GENERAL REGULATIONS OF PLUMBING CONSTRUCTION.	4715.0900	FIXTURE TRAP REQUIREMENTS.
4715.0310	USE OF PUBLIC SEWER AND WATER SYSTEMS REQUIRED.	4715.0910	TRAPS DESCRIBED.
4715.0320	CONFORMANCE WITH CODE.	4715.0920	TRAP PROTECTION.
4715.0330	ALTERNATE FIXTURES, APPURTENANCES, MATERIALS, AND METHODS.	4715.0930	SIZES OF TRAPS.
4715.0340	HEALTH AND SAFETY.	4715.0940	SLIP JOINTS AND UNIONS.
	MATERIALS	4715.0950	TRAP SEALS.
4715.0400	QUALITY OF MATERIALS.	"4715.0950	TRAP SEALS.
4715.0410	IDENTIFICATION OF MATERIALS.	4715.0960	TRAPS PROHIBITED.
4715.0420	STANDARDS FOR PLUMBING MATERIALS.	4715.0970	TRAP CLEANOUTS.
	PIPING SYSTEM MATERIALS		DRAINAGE PIPE CLEANOUTS
4715.0500	WATER SUPPLY SYSTEMS.	4715.1000	LOCATION.
4715.0510	WATER SERVICE PIPE.	4715.1010	SIZE OF CLEANOUTS.
4715.0520	WATER DISTRIBUTION PIPE.	4715.1020	CLEANOUT MATERIALS.
4715.0530	BUILDING SEWERS.	4715.1030	CLEANOUTS TO BE ACCESSIBLE.
4715.0540	STORM WATER AND YARD DRAINAGE (OUTSIDE FOUNDATION WALLS).		INTERCEPTORS, SEPARATORS, AND BACKWATER VALVES
4715.0550	STORM WATER OR CLEAR WATER DRAINAGE (WITHIN BUILDINGS UNDERGROUND).	4715.1100	INTERCEPTORS AND SEPARATORS REQUIRED.
4715.0560	STORM WATER OR CLEAR WATER DRAINAGE (WITHIN BUILDINGS ABOVE GROUND).	4715.1110	GREASE INTERCEPTORS FOR COMMERCIAL BUILDINGS.
4715.0570	SOIL AND WASTE PIPING UNDERGROUND OR EMBEDDED.	4715.1115	EXTERIOR GREASE INTERCEPTORS.
4715.0580	SOIL AND WASTE PIPING ABOVE GROUND.	4715.1120	OIL AND FLAMMABLE LIQUIDS SEPARATOR.
4715.0590	VENT PIPING BELOW GROUND.	4715.1130	INTERCEPTORS AND SEPARATORS FOR SPECIFIC INSTALLATIONS.
4715.0600	VENT PIPING ABOVE GROUND.	4715.1140	VENTING OF INTERCEPTORS AND SEPARATORS.
4715.0610	SPECIAL WASTES.	4715.1150	MAINTENANCE OF INTERCEPTORS AND SEPARATORS.
4715.0620	SUBSOIL DRAINS.	4715.1160	BACKWATER VALVES.
4715.0630	SPECIAL MATERIALS.		PLUMBING FIXTURES
4715.0640	FIXTURE MATERIALS.	4715.1200	CONNECTIONS TO PLUMBING SYSTEM REQUIRED.
	JOINTS AND CONNECTIONS	4715.1210	REQUIRED MINIMUM NUMBER OF FIXTURES.
4715.0700	TIGHTNESS.	4715.1220	INSTALLATION OF FIXTURES.
	TYPES OF JOINTS FOR PIPING MATERIAL	4715.1230	AUTOMATIC CLOTHES WASHERS.
4715.0710	ASBESTOS CEMENT SEWER PIPE JOINTS.	4715.1240	BATHTUBS.
4715.0720	BITUMINIZED FIBER DRAIN PIPE JOINT.	4715.1250	DISHWASHING EQUIPMENT.
4715.0730	BURNED LEAD JOINTS.	4715.1260	DRINKING FOUNTAINS.
4715.0740	CAULKED JOINTS.	4715.1300	FLOOR DRAINS.
4715.0750	CEMENT MORTAR JOINTS.	4715.1305	ELEVATOR PIT DRAIN.
4715.0760	COLD JOINT COMPOUND, TAR BASE.	4715.1310	FOOD-WASTE GRINDER UNITS.
4715.0770	FLARED JOINTS.	4715.1320	FLUSHING DEVICES FOR WATER CLOSETS AND URINALS.
4715.0780	GASKET TYPE JOINTS.	4715.1330	FLUSH TANKS.
4715.0790	HOT-POURED JOINTS.	4715.1340	FLUSHOMETER VALVES.
4715.0800	MECHANICAL JOINTS.	4715.1350	GARBAGE CAN WASHERS.
4715.0805	PUSH-ON JOINTS.	4715.1360	LAUNDRY TRAYS.
4715.0810	PLASTIC JOINTS.	4715.1370	LAVATORIES.
4715.0815	JOINTS IN CHEMICAL WASTE PIPE.	4715.1380	SHOWERS.
4715.0820	SOLDERED OR BRAZED JOINTS.	4715.1390	SINKS.
4715.0830	THREADED JOINTS -- SCREWED JOINTS.	4715.1400	SPECIAL PLUMBING FIXTURES.
4715.0840	WIPED JOINTS.	4715.1410	URINALS.
4715.0850	USE OF JOINTS.	"4715.1410	URINALS.
4715.0860	SPECIAL JOINTS.	4715.1420	WATER CLOSETS.
4715.0870	FLANGED FIXTURE CONNECTIONS.		HANGERS AND SUPPORTS AND PROTECTION
		4715.1430	HANGERS AND SUPPORTS.

MINNESOTA RULES 2011

825

PLUMBING CODE

4715.1440	PROTECTION OF PLASTIC PIPE.	4715.2170	BAROMETRIC LOOP.
	INDIRECT WASTE PIPING	4715.2180	HOT WATER SUPPLY SYSTEM.
4715.1500	INDIRECT WASTE CONNECTIONS.	4715.2190	COMBINATION WATER AND SPACE HEATING EQUIPMENT.
4715.1510	INDIRECT WASTE PIPING.	4715.2200	PRESSURE RELIEF VALVES AND TEMPERATURE RELIEF VALVES DEVICES REQUIRED.
4715.1520	CONNECTIONS FROM WATER DISTRIBUTION SYSTEM.	4715.2210	PRESSURE RELIEF VALVES.
4715.1530	STERILIZERS.	4715.2215	THERMAL EXPANSION CONTROL.
4715.1540	POTABLE CLEAR WATER WASTES.	4715.2220	HOT WATER STORAGE TANKS.
4715.1550	DRINKING FOUNTAINS.	4715.2230	TANKLESS AND INSTANTANEOUS TYPE HEATERS.
4715.1560	SWIMMING POOLS.	4715.2240	ACCESS TO WATER HEATERS.
4715.1570	METHOD OF PROVIDING AN AIR GAP.	4715.2250	DISINFECTION OF POTABLE WATER SYSTEM.
4715.1580	METHOD OF PROVIDING AN AIR BREAK.	4715.2280	WATER METER INSTALLATION.
4715.1590	RECEPTORS OR SUMPS.		DETERMINING SIZE OF DRAINAGE SYSTEM
	SPECIAL WASTES	4715.2300	LOAD ON DRAINAGE PIPING.
4715.1600	CHEMICAL WASTES.	4715.2310	SELECTING SIZE OF GRAVITY DRAINAGE PIPING.
4715.1610	STEAM AND HOT WATER WASTES.	4715.2320	MINIMUM SIZE OF SOIL AND WASTE STACKS.
	WATER SUPPLY AND DISTRIBUTION	4715.2330	MINIMUM SIZE OF STACK VENT OR VENT STACK.
4715.1700	WATER REQUIRED.	4715.2340	PROVISION FOR FUTURE FIXTURES.
4715.1710	WATER SERVICE.	4715.2350	MINIMUM SIZE OF UNDERGROUND DRAINAGE PIPING.
4715.1720	DESIGN OF BUILDING WATER DISTRIBUTION SYSTEM.	4715.2360	SIZING OF OFFSETS ON DRAINAGE PIPING.
4715.1730	SIZE OF FIXTURE BRANCH.	4715.2370	FIXTURE CONNECTIONS TO AN OFFSET OF MORE THAN 45 DEGREES OR AT BASE OF STACK.
4715.1740	WATER PRESSURE.		DRAINAGE PIPING INSTALLATION
4715.1750	WATER HAMMER.	4715.2400	PITCH ON HORIZONTAL DRAINAGE PIPING.
4715.1760	SUPPLY DEMAND.	4715.2410	CHANGE IN DIRECTION.
4715.1770	MINIMUM PRESSURES REQUIRED IN WATER DISTRIBUTION SYSTEM.	4715.2420	PROHIBITED FITTINGS AND CONNECTIONS.
	INSTALLING THE BUILDING WATER DISTRIBUTION SYSTEM	4715.2430	DRAINS BELOW BUILDING SEWER.
4715.1800	WATER SUPPLY CONTROL VALVES.	4715.2440	DESIGN OF SUMPS.
4715.1810	WATER PRESSURE BOOSTER SYSTEMS.		VENTS AND VENTING
	PROTECTION OF POTABLE WATER SUPPLY	4715.2500	SELECTING SIZE OF VENT PIPING.
4715.1900	DESIGN, MAINTENANCE, AND INSTALLATION.	4715.2510	PROTECTION OF TRAP SEALS.
4715.1910	IDENTIFICATION OF POTABLE AND NONPOTABLE WATER.	4715.2520	VENT STACKS AND STACK VENTS.
4715.1911	TOXIC MATERIALS AND USED PIPE.	4715.2530	VENT TERMINALS.
4715.1912	USED WATER RETURN PROHIBITED.	4715.2540	VENT GRADES AND CONNECTIONS.
4715.1920	CROSS-CONNECTION CONTROL.	4715.2550	WET VENTING.
4715.1940	POTABLE WATER CONNECTIONS TO HEATING OR COOLING SYSTEMS.	4715.2560	STACK VENTING.
4715.1941	HEAT EXCHANGERS.	4715.2570	INDIVIDUAL FIXTURE REVENTING REQUIRED.
4715.1950	PROHIBITED CONNECTIONS TO FIXTURES AND EQUIPMENT.	4715.2580	COMMON VENTS.
4715.1960	REFRIGERATING UNIT CONDENSERS AND COOLING JACKETS.	4715.2600	CIRCUIT AND LOOP VENTING.
	PROTECTION OF POTABLE WATER AGAINST BACKFLOW AND BACK-SIPHONAGE	4715.2610	FIXTURES BACK-TO-BACK.
4715.2000	WATER OUTLETS.	4715.2620	FIXTURE VENTS.
4715.2010	MINIMUM REQUIRED AIR GAP.	4715.2630	VENTS FOR FIXTURE TRAP BELOW TRAP DIP.
4715.2020	DEVICES OR ASSEMBLIES FOR THE PROTECTION OF THE POTABLE WATER SUPPLY.	4715.2640	YOKE VENTS FOR STACKS OF MORE THAN FIVE BRANCH INTERVALS.
4715.2030	APPROVAL OF DEVICES OR ASSEMBLIES.	4715.2650	COMBINATION WASTE AND VENT SYSTEM.
	INSTALLATION OF DEVICES	4715.2655	ISLAND FIXTURE VENTING.
4715.2100	BACKFLOW PREVENTERS.	4715.2660	VENTING OF SUMPS AND SEWERS.
4715.2110	TYPES OF DEVICES REQUIRED WHERE AN AIR GAP CANNOT BE PROVIDED.1		STORM DRAINS
4715.2120	LOCATION OF BACKFLOW PREVENTERS.	4715.2700	STORM SEWER SYSTEMS.
4715.2150	CONNECTIONS NOT SUBJECT TO BACK PRESSURE.	4715.2710	SIZE OF BUILDING STORM DRAINS AND LEADERS.
4715.2160	CONNECTIONS SUBJECT TO BACK PRESSURE.	4715.2720	SUBSOIL DRAINS.
4715.2161	INSTALLATION OF REDUCED PRESSURE BACKFLOW PREVENTERS.	4715.2730	BUILDING SUBDRAINS.
4715.2162	DOUBLE CHECK -- DOUBLE GATE VALVE ASSEMBLIES.	4715.2740	TRAPS ON STORM DRAINS AND LEADERS.
4715.2163	CARBONATED BEVERAGE MACHINES.	4715.2750	CONDUCTORS AND CONNECTIONS.
4715.2165	CHEMICAL/SOAP DISPENSING SYSTEMS.	4715.2760	ROOF AND DECK DRAINS.
		4715.2770	PROVISIONS FOR EXPANSION.

4715.0100 PLUMBING CODE

4715.2780	CONTROL FLOW STORM WATER DRAINAGE FOR DEAD LEVEL ROOFS.	4715.3600	TOTAL DAILY WATER REQUIREMENTS.
	INSPECTION, TESTS, AND MAINTENANCE	4715.3700	DETERMINATION OF PEAK DEMAND.
4715.2800	INSPECTIONS.	4715.3800	RECOMMENDED GUIDE FOR SIZING WATER SUPPLY SYSTEM.
4715.2810	NOTIFICATIONS.	4715.4100	USEFUL INFORMATION.
4715.2820	METHOD OF TESTING.		WATER CONDITIONING CONTRACTORS AND INSTALLERS
4715.2830	COVERING OF WORK.	4715.5000	SCOPE AND APPLICABILITY.
4715.2840	DEFECTIVE WORK.	4715.5100	DEFINITIONS.
4715.2850	AIR TEST OF DEFECTIVE PLUMBING.	4715.5200	CONNECTION WITH WATER DISTRIBUTION SYSTEM.
4715.2860	MAINTENANCE.	4715.5300	EQUIPMENT DRAIN.
4715.2870	DISINFECTION OF WATER PIPING.	4715.5400	LOCATION.
4715.2880	BUILDING SEWER.	4715.5500	REGENERATION SANITATION PROCEDURES.
4715.2890	CERTIFICATE OF APPROVAL.	4715.5700	EQUIPMENT AND MATERIALS USED IN INSTALLATIONS.
	PLUMBERS AND PLUMBING; REQUIREMENTS	4715.5800	LICENSING.
4715.3130	PLANS AND SPECIFICATIONS.	4715.6000	RENEWAL.
	EXPLANATORY MATERIALS		
4715.3500	GENERAL.		

4715.0100 DEFINITIONS.

Subpart 1. **Scope.** For the purpose of this code, the following terms shall have the meanings indicated in this part. No attempt is made to define ordinary words which are used in accordance with their established dictionary meanings except where it is necessary to define their meanings as used in this code to avoid misunderstanding.

Subp. 2. **Administrative authority.** "Administrative authority" means the commissioner of labor and industry. (When a governmental subdivision adopts and maintains a comprehensive plumbing enforcement program that is conducted by personnel who are knowledgeable about plumbing installation requirements, and includes enforcement of all code provisions including materials, methods, inspection, and testing, the administrative authority shall be the governing body of the adopting unit of government, its agents, and employees; however, the commissioner of labor and industry retains the ultimate authority to enforce Minnesota Statutes, sections 326B.43 to 326B.49, and provisions of this chapter that are necessary to ensure compliance.)

Subp. 3. **Air break.** "Air break" means a piping arrangement in which a fixture, appliance, or device is protected from backflow by discharging at or below the flood level rim of another fixture or receptacle whose flood level rim is lower than the bottom of the protected fixture, appliance, or device.

Subp. 4. **Air gap.** "Air gap" when used in reference to the drainage system means the unobstructed vertical distance through the free atmosphere between the outlet of a waste pipe and the flood level rim of the fixture or receptacle into which it is discharging.

Subp. 5. **Air gap.** "Air gap" when used in reference to the water distribution system means the unobstructed vertical distance through the free atmosphere between the lowest opening from any pipe or faucet supplying water to a tank, plumbing fixture, or other device, and the flood level rim of the receptacle.

Subp. 6. **anchors.** See "supports."

Subp. 7. **Approved.** "Approved," as applied to a material, device, or mode of construction, means approved by the administrative authority in accordance with the provisions of this code, or by other authority designated by law to give approval in the matter in question.

Subp. 8. **Area drain.** "Area drain" means a receptacle designed to collect surface or storm water from an open area.

Subp. 9. **Backflow.** "Backflow" means the flow of water or other liquids, mixtures, or substances into the distributing pipes of the potable supply of water, from any source or sources other than its intended source. Back-siphonage is one type of backflow.

Subp. 10. **Backflow connection.** "Backflow connection" means any condition whereby backflow can occur.

Subp. 11. **Backflow preventer.** "Backflow preventer" means a device or means to prevent backflow into the potable water system.

Subp. 12. **Backflow preventer (reduced pressure zone type).** "Backflow preventer (reduced pressure zone type)" means an assembly of differential valves and check valves including an automatically opened spillage port to the atmosphere.

Subp. 13. **Back-siphonage.** "Back-siphonage" means the flowing back of used, contaminated, or polluted water from a plumbing fixture or vessel or other sources, into a potable water supply pipe due to negative pressure in such pipe.

Subp. 14. **Barometric loop.** "Barometric loop" means a loop of water piping rising approximately 35 feet at its topmost point above the highest fixture it supplies.

Subp. 15. **Battery of fixtures.** "Battery of fixtures" means any group of two or more similar adjacent fixtures which discharge into a common horizontal waste or soil branch.

Subp. 16. **Boiler blowoff.** "Boiler blowoff" means an outlet on a boiler to permit emptying or discharge of sediment.

Subp. 17. **Boiler blowoff tank.** "Boiler blowoff tank" means a vessel designed to receive the discharge from a boiler blowoff outlet and to cool the discharge to a temperature which permits its safe discharge to the drainage system.

Subp. 18. **Branch.** "Branch" means any part of the piping system other than a riser, main, or stack.

Subp. 19. **Branch, fixture.** See "fixture branch."

Subp. 20. **Branch, horizontal.** See "horizontal branch."

Subp. 21. **Branch interval.** "Branch interval" means a vertical length of stack corresponding in general to a story height, but in no case less than eight feet, within which the horizontal branches from one story or floor of the building are connected to the stack.

Subp. 22. **Branch vent.** "Branch vent" means a vent connecting one or more individual vents with a vent stack or a stack vent.

Subp. 23. **Building classification.** "Building classification" means the arrangement adopted by the administrative authority for the designation of buildings in classes according to occupancy.

Subp. 24. **Building drain.** "Building drain" means that part of the lowest piping of the drainage system which receives the discharge from soil, waste, and other drainage pipes inside the walls of the building and conveys it to the building sewer beginning at least one foot outside the building footings.

Subp. 25. **Building drain, sanitary.** "Building drain, sanitary" means a building drain which conveys sewage only.

Subp. 26. **Building drain, storm.** "Building drain, storm" means a building drain which conveys storm water but no sewage.

Subp. 27. **Building sewer.** "Building sewer" means that part of the drainage system which extends from the end of the building drain and conveys its discharge to the public sewer, private sewer, individual sewage-disposal system, or other point of disposal.

Subp. 28. **Building sewer, sanitary.** "Building sewer, sanitary" means a building sewer which conveys sewage only.

Subp. 29. **Building sewer, storm.** "Building sewer, storm" means a building sewer which conveys storm water but no sewage.

Subp. 30. **Building subdrain.** "Building subdrain" means that portion of a drainage system which cannot drain by gravity into the building sewer.

Subp. 31. **Circuit vent.** "Circuit vent" means a branch vent that serves two or more traps and extends from the downstream side of the highest fixture connection of a horizontal branch to the vent stack.

Subp. 32. **Combination fixture.** "Combination fixture" means a fixture combining one sink and laundry tray or a two or three compartment sink and laundry tray in one unit.

Subp. 33. **Common vent.** "Common vent" means a vent connecting at the junction of two fixture drains and serving as a vent for both fixture drains.

Subp. 34. **Conductor.** "Conductor" means a pipe inside the building which conveys storm water from the roof to a storm drain.

Subp. 35. **Continuous vent.** A "continuous vent" is a vertical vent that is a continuation of the drain to which it connects.

Subp. 36. **Continuous waste.** "Continuous waste" means a drain from two or three compartments of a fixture connected to a single trap.

Subp. 37. **Cross connection.** "Cross connection" means any connection or arrangement, physical or otherwise, between a potable water supply system and any plumbing fixture, or tank, receptacle, equipment, or device through which it may be possible for non-potable, used, unclean, polluted, or contaminated water or other substance to enter any part of such potable water system under any condition.

Subp. 38. **Dead end.** "Dead end" means a branch leading from a soil, waste, or vent pipe, building drain, or building sewer and terminating at a developed length of two feet or more by means of a plug, cap, or other fitting. *[See Note.]*

Subp. 39. **Developed length.** "Developed length" means the length of pipe measured along the center line of the pipe and fittings.

Subp. 40. **Downspout.** See "leader."

Subp. 41. **Drain.** "Drain" means any pipe which carries waste water or waterborne wastes in a building drainage system.

Subp. 42. **Drainage system.** "Drainage system" includes all the piping which conveys sewage, rain water, or other liquid wastes to a legal point of disposal. It does not include the mains of a public sewer system, or a public sewage treatment or disposal plant.

Subp. 43. **Dwelling unit.** "Dwelling unit" means one or more rooms with provision for living, sanitary, and sleeping facilities arranged for the use of one family or individual.

Subp. 44. **Effective opening.** "Effective opening" means the minimum cross-sectional area at the point of water supply discharge measured or expressed in terms of diameter of a circle, or if the opening is not circular, the diameter of a circle of the equivalent cross sectional area.

Subp. 45. **Existing work.** "Existing work" is a plumbing system or any part thereof which has been installed prior to the effective date of this code.

Subp. 45a. **Factory-trained installer.** "Factory-trained installer" means a person who has received training from the manufacturer on installation of that manufacturer's specific plumbing product, and holds a valid certificate of competency issued by the manufacturer for the completion of that training.

Subp. 46. **Fixture.** See "plumbing fixture."

Subp. 47. **Fixture branch.** A "fixture branch" is a water supply pipe between the fixture supply pipe and a water distributing pipe.

Subp. 48. **Fixture drain.** "Fixture drain" means the drain from the trap of a fixture to the junction of that drain with any other drain pipe.

Subp. 49. **Fixture supply.** A "fixture supply" is a water supply pipe connecting the fixture with the fixture branch.

Subp. 50. **Fixture unit (drainage - d.f.u.).** A "drainage fixture unit" is a common measure of the probable discharge into the drainage system by various types of plumbing fixtures on the basis of one d.f.u. being equal to 7.5 gallons per minute discharge. The drainage fixture unit value for a particular fixture depends on its volume rate of drainage

discharge, on the time duration of a single drainage operation, and on the average time between successive operations.

Subp. 51. **Fixture unit (supply - s.f.u.).** A "supply fixture unit" is a common measure of the probable hydraulic demand on the water supply by various types of plumbing fixtures. The supply fixture unit value for a particular fixture depends on its volume rate of supply operation, and on the average time between successive operations.

Subp. 52. **Flood level rim.** "Flood level rim" means the top edge of the receptacle from which water overflows.

Subp. 53. **Flow pressure.** "Flow pressure" the pressure in the water supply pipe near the faucet or water outlet while the faucet or water outlet is wide open and flowing.

Subp. 54. **Flushometer valve.** "Flushometer valve" means a device which discharges a predetermined quantity of water to fixtures for flushing purposes and is actuated by direct water pressure.

Subp. 55. **Flush valve.** "Flush valve" means a device located at the bottom of a flush tank for flushing water closets and similar fixtures.

Subp. 55a. **Fouling waste.** "Fouling waste" means waste that is harmful to the drainage system consisting of grease, dairy, heavy solids, animal matters, feathers, or similar waste that may settle out or deposit on pipes, reducing effective pipe diameter, or otherwise impeding flow.

Subp. 56. **Grade.** "Grade" means the fall (slope) of a line of pipe in reference to a horizontal plane. In drainage it is usually expressed as the fall in a fraction of an inch per foot length of pipe.

Subp. 57. **Grease interceptor.** See "interceptor."

Subp. 58. **Hangers.** See "supports."

Subp. 59. **Horizontal branch drain.** "Horizontal branch drain" means a drain pipe extending horizontally from a soil or waste stack or building drain with or without vertical sections or branches, which receives the discharge from one or more fixture drains on the same floor as the horizontal branch and conducts it to the soil or waste stack or to the building drain.

Subp. 60. **Horizontal pipe.** "Horizontal pipe" means any pipe or fitting which makes an angle of less than 45 degrees with the horizontal.

Subp. 61. **Individual sewage disposal system.** "Individual sewage disposal system" means a system for disposal of sewage designed for use apart from a public sewer as regulated under rules administered by the Pollution Control Agency.

Subp. 62. **Indirect waste pipe.** "Indirect waste pipe" means a waste pipe that does not connect directly with the drainage system but conveys liquid wastes by discharging into a plumbing fixture, interceptor, or receptacle which is directly connected to the drainage system.

Subp. 63. **Individual vent.** "Individual vent" means a pipe installed to vent a fixture trap and which connects with the vent system above the fixture served or terminates in the open air.

Subp. 64. **Industrial wastes.** "Industrial wastes" means liquid or waterborne waste from industrial or commercial processes except domestic sewage.

Subp. 65. **Insanitary.** "Insanitary" means a condition which is contrary to sanitary principles or injurious to health.

Subp. 66. **Interceptor.** "Interceptor" means a device designed and installed so as to separate and retain deleterious, hazardous, or undesirable matter from normal wastes while permitting normal sewage or liquid wastes to discharge into the drainage system by gravity.

Subp. 67. **Leader.** "Leader" means the water conductor from the roof to the building storm drain or other means of disposal.

Subp. 67a. **Food establishment.** "Food establishment" as used in this chapter means a "food and beverage service establishment" as that term is defined in Minnesota Statutes, section 157.15, subdivision 5, or a "place of business" as that term is defined in Minnesota Statutes, section 28A.03, subdivision 4.

Subp. 68. **Liquid waste.** "Liquid waste" means the discharge from any fixture, appliance, or appurtenance which does not receive fecal matter.

Subp. 69. **Load factor.** "Load factor" means the percentage of the total connected fixture unit flow which is likely to occur at any point in the plumbing system.

Subp. 70. **Loop vent.** "Loop vent" means a circuit vent which loops back to connect with a stack vent instead of a vent stack.

Subp. 71. **Main.** "Main" means the principal pipe artery to which branches may be connected.

Subp. 72. **Main vent.** "Main vent" means the principle artery of the venting system to which vent branches may be connected.

Subp. 73. **May.** The word "may" is a permissive or allowable term for alternative procedures.

Subp. 73a. **Must.** The word "must" is a mandatory term.

Subp. 74. **Nonpotable water.** "Nonpotable water" means water not safe for drinking because it may contain impurities in amounts sufficient to cause disease or harmful physiological effects, or water that does not conform to the public water supply quality requirements of parts 4720.0100 to 4720.2500 or the regulations of the local public health authority having jurisdiction.

Subp 74a. *[See Note.]*

Subp. 75. **Offset.** "Offset" means a combination of elbows or bends which brings one section of the pipe out of line but into a line parallel with the other section.

Subp. 76. **Plumbing.** "Plumbing" means the business, trade, or work having to do with the installation, removal, alteration, or repair of plumbing and drainage systems or parts thereof.

Subp. 77. **Plumbing appliance.** "Plumbing appliance" means any one of a special class of plumbing fixture which is intended to perform a special function. Its operation and/or control may be dependent upon one or more energized components, such as motors, controls, heating elements, or pressure or temperature-sensing elements. Such fixtures may operate automatically through one or more of the following actions: a time cycle, a temperature range, a pressure range, a measured volume or weight, or the fixture may be manually adjusted or controlled by the user or operator.

Subp. 78. **Plumbing appurtenance.** "Plumbing appurtenance" means a manufactured device, or a prefabricated assembly, or an on-the-job assembly of component parts, and which is an adjunct to the basic piping system and plumbing fixtures. An appurtenance demands no additional water supply, nor does it add any discharge load to a fixture or the drainage system. It is presumed that it performs some useful function in the operation, maintenance, servicing, economy, or safety of the plumbing system.

Subp. 79. **Plumbing inspector official.** See "administrative authority."

Subp. 80. **Plumbing fixture.** "Plumbing fixture" means a receptacle or device which is either permanently or temporarily connected to the water distribution system, and demands a supply of water therefrom, or it discharges used water, liquid-borne waste materials, or sewage either directly or indirectly to the drainage system, or which requires both a water supply connection and a discharge to the drainage system. Plumbing appliances as a special class of fixture are further defined.

Subp. 81. **Plumbing system.** The "plumbing system" means and includes all potable water supplies and distribution pipes, all plumbing fixtures and traps, all drainage and vent pipes and all building drains, including their respective joints and connections, devices and

appurtenances within the property lines of the premises and shall include potable water treatment or using equipment.

Subp. 82. **Potable water.** "Potable water" means water free from impurities present in amounts sufficient to cause disease or harmful physiological effects and conforming in its bacteriological and chemical quality to parts 4720.0100 to 4720.2500 or the regulations of the local public health authority having jurisdiction.

Subp. 83. **Private or private use.** In the classification of plumbing fixtures, "private" applies to fixtures in residences and apartments, and to fixtures in private bathrooms of hotels, as well as similar installations in other buildings where fixtures are intended for use of one family or an individual.

Subp. 84. **Public or public use.** In the classification of plumbing fixtures, "public" applies to fixtures in general toilet rooms of schools, gymnasiums, hotels, railroad stations, bars, public comfort stations, and other installations (whether pay or free) where fixtures are installed so that their use is similarly unrestricted.

Subp. 84a. **Readily accessible.** "Readily accessible" means capable of being reached safely and quickly for operation, repair, or inspection without requiring those to whom ready access is requisite to remove obstacles, panels, or similar obstructions.

Subp. 85. **Receptor.** "Receptor" means an approved plumbing fixture or device of such material, shape, and capacity as to adequately receive the discharge from indirect waste pipes, so constructed and located as to be readily cleaned.

Subp. 86. **Relief vent.** "Relief vent" means a vent, the primary function of which is to provide additional circulation of air between drainage and vent systems or to act as an auxiliary vent on a specially designed system.

Subp. 87. **Return offset.** "Return offset" means a double offset installed so as to return the pipe to its original alignment.

Subp. 88. **Revent pipe.** See "individual vent."

Subp. 89. **Rim.** "Rim" means an unobstructed open edge of a fixture.

Subp. 90. **Riser.** "Riser" means a water supply pipe which extends vertically one full story or more to convey water to branches or to a group of fixtures.

Subp. 91. **Roof drain.** "Roof drain" means a drain installed to receive water collecting on the surface of a roof and to discharge it into a leader or conductor.

Subp. 92. **Roughing in.** "Roughing in" means the installation of all parts of the plumbing system which can be completed prior to the installation of fixtures. This includes drainage, water supply, and vent piping, and necessary fixture supports.

Subp. 93. **Sand interceptor or trap.** See "interceptor."

Subp. 94. **Sanitary sewer.** "Sanitary sewer" means a sewer which carries sewage and excludes storm, surface, and ground water.

Subp. 95. **Sewage.** "Sewage" means any liquid waste containing animal or vegetable matter in suspension or solution and may include liquids containing chemicals in solution.

Subp. 96. **Sewage ejector.** "Sewage ejector" means a device for moving sewage by entraining it in a high velocity jet of steam, air, or water.

Subp. 97. **Sewer.** "Sewer" means an artificial conduit, usually underground, for carrying off waste water and refuse.

Subp. 98. **Slope.** See "grade."

Subp. 99. **Shall.** The word "shall" is a mandatory term.

Subp. 100. **Should.** The word "should" is a nonmandatory term, but describes recommended procedures.

Subp. 101. **Soil pipe.** "Soil pipe" means a pipe which conveys the discharge of water closets or similar fixtures containing fecal matter with or without the discharge of other fixtures to the building drain or building sewer.

Subp. 102. **Special wastes.** "Special wastes" means wastes which require special treatment before entry into the normal plumbing system.

Subp. 103. **Special waste pipe.** "Special waste pipe" means pipe which conveys special wastes.

Subp. 104. **Stack.** "Stack" is a general term for any vertical line of soil, waste, or vent piping extending through one or more stories. Excepting vertical vent branches which do not extend through the roof and which pass through less than two stories, before being reconnected to a vent stack or stack vent.

Subp. 105. **Stack group.** "Stack group" means a group of fixtures located adjacent to the stack so that by means of proper fittings, vents may be reduced to a minimum.

Subp. 106. **Stack vent.** "Stack vent" means the extension of a soil or waste stack above the highest horizontal drain connected to the stack.

Subp. 107. **Storm drain.** See "building drain, storm."

Subp. 108. **Storm sewer.** "Storm sewer" means a sewer used for conveying ground water, rain water, surface water, or similar nonpollutional wastes.

Subp. 109. **Sump.** "Sump" means a watertight tank which receives sewage or liquid waste and which is located below the normal grade of the gravity system and must be emptied by mechanical means.

Subp. 110. **Sump pump.** "Sump pump" means a mechanical device other than an ejector for removing sewage or liquid waste from a sump.

Subp. 111. **Supports.** "Supports" means devices for supporting and securing pipe, fixtures, and equipment.

Subp. 112. **Trap.** "Trap" means a fitting or device which provides, when properly vented, a liquid seal to prevent the emission of sewer gases without materially affecting the flow of sewage or waste water through it.

Subp. 113. **Trap seal.** "Trap seal" means the vertical distance between the crown wire and the top dip of the trap.

Subp. 114. **Vacuum.** "Vacuum" means any pressure less than that exerted by the atmosphere.

Subp. 115. **Vacuum breaker, nonpressure type (atmospheric).** "Nonpressure type vacuum breaker" means a vacuum breaker which is not designed to be subjected to static line pressure.

Subp. 116. **Vacuum breaker, pressure type.** "Vacuum breaker, pressure type" means a vacuum breaker designed to operate under conditions of static line pressure.

Subp. 117. **Vent pipe.** "Vent pipe" means any pipe provided to ventilate a building drainage system and to prevent trap siphonage and back pressure.

Subp. 118. **Vent stack.** "Vent stack" means a vertical vent pipe installed to provide circulation of air to and from the drainage system.

Subp. 119. **Vent system.** "Vent system" means a pipe or pipes installed to provide a flow of air to or from a drainage system or to provide a circulation of air within such system to protect trap seals from siphonage and back pressure.

Subp. 120. **Vertical pipe.** "Vertical pipe" means any pipe or fitting which makes an angle of 45 degrees or less with the vertical.

Subp. 121. **Waste.** See "liquid waste" and "industrial waste."

Subp. 122. **Waste pipe.** "Waste pipe" means a pipe which conveys only liquid waste free from fecal material.

Subp. 123. **Water distributing pipe.** "Water distributing pipe" means a pipe conveys water from the water service pipe to the point of usage.

Subp. 124. **Water outlet.** "Water outlet" means a discharge opening through which water is supplied to a fixture, into the atmosphere (except into an open tank which is part of the water supply system), to a boiler or heating system, or to any devices or equipment requiring water to operate.

Subp. 125. **Water service pipe.** "Water service pipe" means the pipe from the water main or other source of water supply to the water distributing system of the building served.

Subp. 126. **Water supply system.** "Water supply system" means the water service pipe, the water distributing pipes, and the necessary connecting pipes, fittings, control valves, and all appurtenances within the building or outside the building within the property lines.

Subp. 127. **Wet vent.** "Wet vent" means a vent which also serves as a drain.

Subp. 128. **Yoke vent.** A "yoke vent" is a pipe connecting upward from a soil or waste stack to a vent stack for the purpose of preventing pressure changes in the stacks.

Statutory Authority: *MS s 14.389; 16B.59 to 16B.75; 326.37 to 326.45; 326B.101 to 326B.194; 326B.43 to 326B.49*

History: *9 SR 1557; L 1977 c 305 s 39; 11 SR 1405; 15 SR 76; 23 SR 686; L 2007 c 140 art 4 s 61; art 6 s 15; art 13 s 4; L 2008 c 337 s 64; 33 SR 2042; 35 SR 1171*

NOTE: Subpart 38 was amended and subpart 74a was added effective July 5, 2011. When effective, subparts 38 and 74a will read:

"Subp. 38. **Dead end.** "Dead end" means a branch leading from a soil, waste, or vent pipe, building drain, building sewer, or water distribution branch, and terminating at a developed length of two feet or more by means of a plug, cap, or other fitting."

"Subp. 74a. **Nonwater urinal.** "Nonwater urinal" means a plumbing fixture that is designed to receive and convey only liquid waste through a trap seal into the gravity drainage system without the use of water for such function."

Statutory Authority: *MS s 14.389*

History: *35 SR 1171*

4715.0200 BASIC PLUMBING PRINCIPLES.

This code is founded upon certain basic principles of environmental sanitation and safety through properly designed, acceptably installed and adequately maintained plumbing systems. Some of the details of plumbing construction may vary but the basic sanitary and safety principles desirable and necessary to protect the health of the people are the same everywhere. As interpretations may be required, and as unforeseen situations arise which are not specifically covered in this code, the twenty three principles which follow shall be used to define the intent.

A. All premises intended for human habitation, occupancy, or use shall be provided with a potable water supply which meets the requirements of the commissioner of health. Such water supply shall not be connected with unsafe water sources nor shall it be subject to the hazards of backflow or back-siphonage.

B. Proper protection shall be provided to prevent contamination of food, water, sterile goods, and similar materials by backflow of sewage. When necessary, the fixtures, device, or appliance shall be connected indirectly with the building drainage system.

C. Each family dwelling unit shall have at least one water closet, one lavatory, one kitchen type sink, and one bathtub or shower to meet the basic requirements of sanitation and personal hygiene. All other structures for habitation shall be equipped with sufficient sanitary facilities.

D. The building sewer in every building with installed plumbing fixtures and intended for human habitation, occupancy, or use when located on premises where the authority having jurisdiction has determined that a public sewer is available shall be connected to the public sewer.

E. The building drainage system shall be designed to provide adequate circulation of air in all pipes with no danger of siphonage, aspiration, or forcing of trap seals under conditions of ordinary use.

F. The drainage system shall be designed, constructed, and maintained to conduct the waste water with velocities which will prevent fouling, deposition of solids, and clogging.

G. The drainage system shall be provided with an adequate number of cleanouts so arranged that in case of stoppage the pipes may be readily cleaned.

H. Where a building drainage system may be subjected to back flow of sewage, suitable provision shall be made to prevent its overflow in the building.

I. Each vent terminal shall extend to the outer air and be so installed as to minimize the possibilities of clogging and the return of foul air to the building.

J. No substance which will clog or accentuate clogging of pipes, produce explosive mixtures, destroy the pipes or their joints, or interfere unduly with the sewage disposal process shall be allowed to enter the drainage system.

K. The piping of the plumbing system shall be of durable material free from defective construction and so designed and constructed as to give satisfactory service for its reasonable expected life.

L. The plumbing system shall be subjected to adequate tests and to inspections in a manner that will disclose all leaks and defects in the work or the material.

M. Plumbing systems shall be maintained in a safe and serviceable condition from the standpoint of both mechanics and health.

N. Plumbing shall be installed with due regard to preservation of the strength of structural members and prevention of damage to the walls and other surfaces through fixture usage.

O. Plumbing fixtures shall be made of durable, smooth, nonabsorbent, and corrosion-resistant material and shall be free from concealed fouling surfaces.

P. Plumbing fixtures, devices, and appurtenances shall be supplied with water in sufficient volume and at pressures adequate to enable them to function properly and without undue noise under normal conditions of use.

Q. Plumbing fixtures shall be designed and adjusted to use the minimum quantity of water consistent with proper performance and cleaning. Hot water shall be supplied to all plumbing fixtures which normally need or require hot water for their proper use and function.

R. All plumbing fixtures shall be so installed with regard to spacing as to be accessible for their intended use and cleansing.

S. Each fixture shall be provided with a separate, accessible, self-scouring, reliable water-seal trap placed as near to the fixture as possible.

T. No water closet or similar fixture shall be located in a room or compartment which is not properly lighted and ventilated.

U. If water closets or other plumbing fixtures are installed in a building where there is no public sewer available as determined by the authority having jurisdiction, suitable provision must be made for treatment of the building sewage by methods which meet the design criteria of the Minnesota Pollution Control Agency.

V. Devices for heating water and storing it shall be designed and installed to prevent all dangers from explosion and overheating.

W. Sewage or other waste shall not be discharged into surface or subsurface water unless it first has been subjected to an acceptable form of treatment.

Statutory Authority: *MS s 14.389; 16B.61; 326.37 to 326.45; 326B.106; 326B.43 to 326B.49*

History: *9 SR 1557; 15 SR 76; 17 SR 1279; L 2007 c 140 art 4 s 61; art 6 s 15; art 13 s 4; 33 SR 2042; 33 SR 1171*

NOTE: This part was amended effective July 5, 2011. When effective, this part will read as follows:
"4715.0200 BASIC PLUMBING PRINCIPLES.

This code is founded upon certain basic principles of environmental sanitation and safety through properly designed, acceptably installed and adequately maintained plumbing systems. Some of the details of plumbing construction may vary but the basic sanitary and safety principles desirable and necessary to protect the health of the people are the same everywhere. As interpretations may be required, and as unforeseen situations arise which are not specifically covered in this code, the twenty three principles which follow shall be used to define the intent.

A. All premises intended for human habitation, occupancy, or use shall be provided with a potable water supply which meets the requirements of the commissioner of health. Such water supply shall not be connected with unsafe water sources nor shall it be subject to the hazards of backflow or back-siphonage.

B. Proper protection shall be provided to prevent contamination of food, water, sterile goods, and similar materials by backflow of sewage. When necessary, the fixtures, device, or appliance shall be connected indirectly with the building drainage system.

C. Each family dwelling unit shall have at least one water closet, one lavatory, one kitchen type sink, and one bathtub or shower to meet the basic requirements of sanitation and personal hygiene. All other structures for habitation shall be equipped with sufficient sanitary facilities.

D. The building sewer in every building with installed plumbing fixtures and intended for human habitation, occupancy, or use when located on premises where the authority having jurisdiction has determined that a public sewer is available shall be connected to the public sewer.

E. The building drainage system shall be designed to provide adequate circulation of air in all pipes with no danger of siphonage, aspiration, or forcing of trap seals under conditions of ordinary use.

F. The drainage system shall be designed, constructed, and maintained to conduct the waste water with velocities which will prevent fouling, deposition of solids, and clogging.

G. The drainage system shall be provided with an adequate number of cleanouts so arranged that in case of stoppage the pipes may be readily cleaned.

H. Where a building drainage system may be subjected to back flow of sewage, suitable provision shall be made to prevent its overflow in the building.

I. Each vent terminal shall extend to the outer air and be so installed as to minimize the possibilities of clogging and the return of foul air to the building.

J. No substance which will clog or accentuate clogging of pipes, produce explosive mixtures, destroy the pipes or their joints, or interfere unduly with the sewage disposal process shall be allowed to enter the drainage system.

K. The piping of the plumbing system shall be of durable material free from defective construction and so designed and constructed as to give satisfactory service for its reasonable expected life.

L. The plumbing system shall be subjected to adequate tests and to inspections in a manner that will disclose all leaks and defects in the work or the material.

M. Plumbing systems shall be maintained in a safe and serviceable condition from the standpoint of both mechanics and health.

N. Plumbing shall be installed with due regard to preservation of the strength of structural members and prevention of damage to the walls and other surfaces through fixture usage.

O. Plumbing fixtures shall be made of durable, smooth, nonabsorbent, and corrosion-resistant material and shall be free from concealed fouling surfaces.

P. Plumbing fixtures, devices, and appurtenances shall be supplied with water in sufficient volume and at pressures adequate to enable them to function properly and without undue noise under normal conditions of use.

Q. Plumbing fixtures shall be designed and adjusted to use the minimum quantity of water consistent with proper performance and cleaning. Hot water shall be supplied to all plumbing fixtures which normally need or require hot water for their proper use and function.

R. All plumbing fixtures shall be so installed with regard to spacing as to be accessible for their intended use and cleansing.

S. Each fixture shall be provided with a separate, accessible, self-scouring, reliable trap placed as near to the fixture as possible.

T. No water closet or similar fixture shall be located in a room or compartment which is not properly lighted and ventilated.

U. If water closets or other plumbing fixtures are installed in a building where there is no public sewer available as determined by the authority having jurisdiction, suitable provision must be made for treatment of the building sewage by methods which meet the design criteria of the Minnesota Pollution Control Agency.

V. Devices for heating water and storing it shall be designed and installed to prevent all dangers from explosion and overheating.

W. Sewage or other waste shall not be discharged into surface or subsurface water unless it first has been subjected to an acceptable form of treatment."

Statutory Authority: *MS s 14.389*

History: *33 SR 1171*

4715.0210 PLUMBING CODE

836

4715.0210 [Renumbered 4715.0200]**4715.0220** [Renumbered 4715.0200]**4715.0230** [Renumbered 4715.0200]**4715.0240** [Renumbered 4715.0200]**4715.0250** [Renumbered 4715.0200]**4715.0260** [Renumbered 4715.0200]**4715.0270** [Renumbered 4715.0200]**4715.0300 GENERAL REGULATIONS OF PLUMBING CONSTRUCTION.**

Subpart 1. **Grades of horizontal piping.** See parts 4715.2400 and 4715.2310, subpart 2.

Subp. 2. **Changes of direction.** See part 4715.2410.

Subp. 3. **Prohibited fittings.** See part 4715.2420.

Subp. 4. **Protection of material.** All pipes passing under or through walls shall be protected from breakage. All pipes passing through or in contact with cinder, concrete, or other corrosive material shall be protected against external corrosion by protective coating, wrapping, or other means that will resist such corrosion.

Subp. 5. **Construction.** Construction shall be of such character as to secure fully the results sought to be obtained in all sections of the code.

Subp. 6. **Exclusion of materials detrimental to drainage system.** See parts 4715.1600 and 4715.1610.

Statutory Authority: *MS s 326.37 to 326.45; 326B.43 to 326B.49*

History: *17 SR 1279; L 2007 c 140 art 6 s 15; art 13 s 4*

4715.0310 USE OF PUBLIC SEWER AND WATER SYSTEMS REQUIRED.

If a public sewer is accessible in a street or alley to a building or premises and the connection is feasible, liquid wastes from any plumbing system in that building must be discharged into the public sewer unless otherwise prohibited by this code or a local ordinance.

If a public water supply system is accessible, the water distribution system must be connected to it unless otherwise permitted by the administrative authority. A water well taken out of service because a person is connecting to a public water supply must either be maintained for a use such as irrigation, or sealed and abandoned in accordance with the Minnesota Water Well Construction Code. (Minnesota Rules, chapter 4725)

If either a public sewer or water supply system or both are not available, an individual water supply or sewage disposal system, or both, conforming to the published standards of the administrative authority must be provided.

Every building must have its own independent connection with a public or private sewer, except that a group of buildings may be connected to one or more manholes which are constructed on the premises, and connected to a public or private sewer. These manholes must conform to the standards set by the local sewer authority.

Statutory Authority: *MS s 16B.61; 326.37 to 326.45; 326B.106; 326B.43 to 326B.49*

History: *9 SR 1557; 15 SR 76; L 2007 c 140 art 4 s 61; art 6 s 15; art 13 s 4*

4715.0320 CONFORMANCE WITH CODE.

Subpart 1. **Scope.** As provided in Minnesota Statutes, section 326B.43, the Minnesota Plumbing Code applies to all new plumbing installations, including additions, extensions,

alterations, and replacements connected to a water or sewage disposal system owned or operated by or for a municipality, institution, factory, office building, hotel, apartment building, or other place of business regardless of location or the population of the city or town in which it is located. [See Note.]

Subp. 2. **New buildings.** All plumbing materials and plumbing systems or parts thereof must be installed to meet the minimum provisions of this code.

Subp. 3. **Existing buildings.** In existing buildings or premises in which plumbing installations are to be altered, renovated, or replaced, the new materials and work must meet the provisions of this code. If the administrative authority finds that the full performance of bringing the work into compliance with all requirements of this code would result in exceptional or undue hardship by reason of excessive structural or mechanical difficulty, or impracticability, a deviation may be granted by the administrative authority only to the extent the deviation can be granted without endangering the health and safety of the occupants and the public.

Statutory Authority: *MS s 14.388; 16B.61; 326.37 to 326.45; 326B.106; 326B.43 to 326B.49*

History: *15 SR 76; L 2007 c 140 art 4 s 61; art 6 s 15; art 13 s 4; 35 SR 1033*

NOTE: Subpart 1 was amended effective June 6, 2011. When effective, subpart 1 will read:

"Subpart 1. **Scope.** As provided in Minnesota Statutes, sections 326B.43 and 326B.52, the Minnesota Plumbing Code applies to all new plumbing installations performed anywhere in the state, including additions, extensions, alterations, and replacements."

Statutory Authority: *MS s 14.388*

History: *35 SR 1033*

4715.0330 ALTERNATE FIXTURES, APPURTENANCES, MATERIALS, AND METHODS.

Subpart 1. **Approval of alternate fixtures.** The administrative authority may approve the use of fixtures, appurtenances, materials, and methods of a type not expressly approved, nor expressly prohibited by, this code after determination that such fixtures, appurtenances, material, or method is of such design or quality, or both, as to appear to be suitable, safe, and sanitary for the use for which it is intended.

Subp. 2. **Proof of suitability of fixture.** Any person desiring to install or use a fixture, appurtenance, material, or method of a type not expressly authorized nor expressly prohibited by this code shall, prior to such installation or use, submit to the administrative authority such proof as may be required to determine whether such fixture, appurtenance, material, or method is of such design or quality, or both, as to appear to be suitable, safe, and sanitary for the use for which it is intended. If the administrative authority determines that it does appear to be suitable, safe, and sanitary for the use which it is intended, it may permit such use.

Subp. 3. **Tests.** When there is insufficient evidence to verify claims for alternate materials, the administrative authority may require as proof of suitability a test by a testing laboratory approved by the administrative authority, at the expense of the applicant, demonstrating that the performance characteristics of the alternate materials are substantially equal to or exceed those of authorized materials.

Tests shall be made in accordance with generally recognized standards; but in the absence of such standards, the administrative authority shall specify the test procedure.

The administrative authority may require tests to be repeated if at any time there is reason to believe that an alternate material no longer conforms to the requirements on which its approval was based.

4715.0330 PLUMBING CODE

838

Subp. 4. **Advisory council.** The administrative authority may appoint an advisory council to study and make recommendations concerning the uses of new fixtures, appurtenances, materials, and methods.

Statutory Authority: *MS s 326.37 to 326.45; 326B.43 to 326B.49*

History: *L 2007 c 140 art 6 s 15; art 13 s 4*

4715.0340 HEALTH AND SAFETY.

Subpart 1. **Installation of additional plumbing.** Where a health or safety hazard exists by reason of an existing plumbing installation or lack thereof, the owner or the owner's agent shall be responsible for installing additional plumbing or making such corrections as may be necessary to abate such nuisance and bring the plumbing installation within the provisions of this code.

Subp. 2. **Condemned equipment.** Any plumbing equipment condemned by the administrative authority because of wear, damage, defects, or sanitary hazards shall not be reused for plumbing purposes.

Subp. 3. **Used material or equipment.** It shall be unlawful to install any used plumbing material or equipment unless it conforms to the standards and rules set forth in this code.

Subp. 4. **Freezing.** Water service piping shall be installed below normal frost penetration for below-grade piping unless special provisions are made to prevent freezing. Plumbing piping in exterior building walls shall be adequately protected against freezing by insulation or heat or both.

Statutory Authority: *MS s 326.37 to 326.45; 326B.43 to 326B.49*

History: *17 SR 1279; L 2007 c 140 art 6 s 15; art 13 s 4*

MATERIALS

4715.0400 QUALITY OF MATERIALS.

All materials used in any drainage or plumbing system or part thereof shall be free from defects, and no materials which are damaged or defective shall knowingly be installed.

Statutory Authority: *MS s 326.37 to 326.45; 326B.43 to 326B.49*

History: *L 2007 c 140 art 6 s 15; art 13 s 4*

4715.0410 IDENTIFICATION OF MATERIALS.

All materials must be marked, unless otherwise easily identifiable, so as to provide a visual means of identification as to types, grades, weights, and strengths. The installer shall, as far as possible, position the identification marks so as to provide ease of inspection by the administrative authority.

Statutory Authority: *MS s 326.37 to 326.45; 326B.43 to 326B.49*

History: *L 2007 c 140 art 6 s 15; art 13 s 4*

4715.0420 STANDARDS FOR PLUMBING MATERIALS.

Subpart 1. **Approved materials.** A material shall be considered approved if it meets one or more of the standards in subpart 3. All approved materials shall be certified to the listed standard by an independent accredited third-party certification agency. Certification reports shall be made available to the administrative authority when requested. Materials not listed in subpart 3 shall be used only as provided for in part 4715.0330, or as permitted elsewhere in this code.

Subp. 2. **Abbreviations.** Abbreviations in this chapter refer to the following:

A. ANSI, American National Standards Institute, 10 East 40th Street, New York, New York 10016;

B. ASTM, American Society for Testing and Materials, 100 Barr Harbor Drive, West Conshohocken, PA 19428-2959;

MINNESOTA RULES 2011

839

PLUMBING CODE 4715.0420

C. AWWA, American Water Works Association, 2 Park Avenue, New York City, New York 10016;

D. CSA, Canadian Standards Association, 178 Rexdale Boulevard, Rexdale (Toronto), Ontario, Canada M9W 1R3;

E. CS, Commercial Standards available from: Commodity Standards Division, Office of Industry and Commerce, U. S. Department of Commerce, Washington, D. C. 20234;

F. FS, Federal Specifications available from: Federal Supply Service, Standards Division, General Services Administration, Washington, D. C. 20406;

G. NSF, NSF International, Ann Arbor, Michigan 48106;

H. FHA, Federal Housing Authority, Architectural Standards Division, Washington, D. C.;

I. AASHTO, American Association of State and Highway Transportation Officials, 444 North Capital Street Northwest, Suite 249, Washington, D. C. 20001;

J. IAPMO, International Association of Plumbing and Mechanical Officials, 5001 E. Philadelphia St., Ontario, California 91761;

K. ASSE, American Society of Sanitary Engineering, 901 Canterbury Road, Suite A, Westlake, Ohio 44145-1480.

Subp. 3. Standards for plumbing materials.

	DESCRIPTION	ANSI	ASTM	FS	OTHER
I.	CAST IRON PIPE AND FITTINGS				
		A21.2			
		A21.6	A-74	WW-P-401C	CS188
1A	Cast Iron Pipe and Fittings Extra Heavy	A21.8			
1B	Cast Iron Pipe Centrifugally Cast Only and Fittings	A21.6	A-74	WW-P-401C	CS188
	Service Weight	A21.8			
1C	Cast Iron Mechanical (Gland Type) Pipe	A21.11 A21.2 A21.6		WW-P-421a	
1D	Cast Iron Mechanical (Gland Type) Pipe Cement Lined	A21.8 A21.4 A21.2 A21.6 A21.8			

MINNESOTA RULES 2011

4715.0420 PLUMBING CODE

840

1E	Cast Iron Short Body Water Service Fittings (2"-12")	A21.10		AWWA C100
1F	Cast Iron Threaded Pipe	A40.5		
1G	High Silicon Pipe, Fittings Cast Iron			
1H	Cast Iron Threaded Fittings Black and Galvanized 125#	B16.4	WW-P-501	
1J	Cast Iron Drainage Fittings Black and Galvanized	B16.12	WW-P-491	
1K	Hubless Cast Iron Pipe and Fittings		A888-07a	CISPI Standard 301-05 CSA/CAN 3-B70
1L	Ductile Iron Pipe Flanged	A21.15		AWWA C115
1M	Ductile Iron Pipe Push-on Joints, Mechanical Joints	A21.51		AWWA C151
II.	STEEL AND WROUGHT IRON PIPE FITTINGS			
2A	Steel Pipe, Welded and Seamless Galvanized, Schedule 40 and Above	B36.1	A53	WW-P-406 6(1)
		B36.20		
2B	Wrought Iron Pipe, Galvanized Schedule 40 and Above	B36.2		
2C(a)	Stainless Steel Pipe	B36.19		
2C(b)	Stainless Steel Pipe	A112.3.1		

MINNESOTA RULES 2011

841 **PLUMBING CODE 4715.0420**

2D Galvanized
Malleable Fittings
150 psi and Above B16.3 A197

2E Steel Unions,
Galvanized WW-V-531 C

2F Corrugated Steel
Pipe, Aluminized
and fittings A760 AASHTO M36
(18- to 120-inch) A796
(Storm only)

III. COPPER AND COPPER BASE PIPE AND FITTINGS

3A Red Brass Pipe,
Regular and Heavier H27.1 B42B

3B Seamless Brass Tube H36.1

3C Brass or Bronze
Threaded Fittings
125 lbs. and Over B16.15 B62 WW-P-460

3D Brass or Bronze
Flare Fittings 125
lbs. and Over, Heavy
Duty Long Collar
Type B62

3E Seamless Copper
Tube Type K, Soft
Temper H23.1 B88

3F Seamless Copper
Tube Type K, Hard
Temper H23.1 B88

3G Seamless Copper
Tube Type L, Soft
Temper H23.1 B88

3H Seamless Copper
Tube Type L, Hard
Temper H23.1 B88

3H(a) Welded Copper
Alloy OFT194-101A

MINNESOTA RULES 2011

4715.0420 PLUMBING CODE

842

	194 Water, Tube, Type "Heavy," Hard Temper		B543-72		Navfac TS-15400
3H(b)	Stainless Steel Water Tubing, Type SL, Copper Plated Coating (HWT-T439)		A-651		
3J	Seamless Copper Tube, Type M, Hard and Soft Temper	H23.1	B88		
3J(a)	Welded Copper Alloy 194 Water Tube, Type "Standard," Hard Temper				OFT194-101A Navfac TS-15400
3J(b)	Stainless Steel Water Tubing, Type SM, Copper Plated Coating (HWT-T439)	A-268		A-651	
3K	Seamless Copper Tube Type DWV	H23.3	B306		
3L	Copper Pipe I.P.S.	H26.1	B42		
3M	Copper Pipe, Threadless Type T P and Fittings	H26.2	B302		
3N	Cast Bronze and Wrought Solder Joint Pressure Fitting	B16.22 H23.1 B16.18			
3O	Cast Bronze and Wrought Solder Joint D W V Fittings	B16.23			
3P	Copper Alloy Water Tube 1/2 Inch and 3/4 Inch		B447 B75		

MINNESOTA RULES 2011

843				PLUMBING CODE 4715.0420
3Q	Welded Brass Water Tube 1/2 Inch and 3/4 Inch	B587		
3R	Removable and Nonremovable Push-Fit Fittings for Copper Pipe (3/8 to 2 inches only)			NSF 61 ASSE 1061-06
IV.	LEAD PIPE AND FITTINGS			
4A	Lead Pipe AA		WW-P-325-44	
4B	Lead Pipe AAA		WW-P-325-44	
4C	Lead Bends and Traps		WW-P-325-44	
4D	Sheet Lead		QQ-L201d	
V.	SILICA AND EARTH PRODUCTS PIPE AND FITTINGS, NONMETALLIC			
5A	Asbestos-Cement Pressure Pipe and Fitting	C500 C296	SS-P351	
5B	Asbestos-Cement Water Pipe and Fittings	C500	SS-P-351	AWWA C400
5C	Asbestos-Cement Nonpressure Pipe and Fittings	C428	XX-P-331	
5D	Asbestos-Cement Perforated Underdrain Pipe and Fittings	C508		
5E	Vitrified Clay Pipe, Standard Strength and Stronger Fittings	C13 C200		
5F	Unglazed Clay Pipe, Extra Strength and Fittings	C278		
5G	Perforated Clay Pipe and Fittings	C211		
5H	Borosilicate Glass Pipe and Fittings 60 psi			

MINNESOTA RULES 2011

4715.0420 PLUMBING CODE

844

5J	Nonreinforced Concrete Drain Tile	C412		AASHTO M178
5K	Nonreinforced Concrete Pipe	C14	SS-P-371	AASHTO M86 CSA-A257.1
5L	Perforated Concrete Pipe, Underdrainage	C444		
5M	Reinforced Concrete Pipe	C76	SS-P-375	CSA-A257.2
5N	Reinforced and Prestressed Concrete Pipe, Pressure Type and Fittings			
5O	Bituminized Fiber Drain and Sewer Pipe	D1860	SS-P-1540A	
5P	Perforated Bituminized Fiber Pipe for General Drainage	D2311	SS-P-1540A	
VI.	PLASTIC PIPE AND FITTINGS DRAIN, WASTE AND VENT			
6A	Acrylonitrile-Butadiene- Styrene (ABS)	D2661	L-P-322a FHA-MPS	NSF14 CSA-B181.1 CS270
	Type 1, Schedule 40 Cellular core	F628		
6B	(1) Polyvinyl Chloride (PVC) Schedule 40 Unthreaded Schedule 80 can be threaded Cellular core	D2665	L-P-320a FHA-MPS	NSF14 CS272 CSA-B181.2
	Fabricated Fittings (8- to 24-inch)	F891	D3311	
	Fabricated Fittings (8-inch and larger with mitered joints 4-inch and larger)	F1866		
6B	(2) Polyvinyl Chloride (PVC) Schedule 30 (3-inch only)	D2949	L-P-001221	

MINNESOTA RULES 2011

845

PLUMBING CODE 4715.0420

6B (3) Polyvinyl Chloride (PVC)
Schedule 40 (14- to 24-inch
only) with ASTM D3311 fittings D1785

Fabricated Fittings (8-inch and F1866
larger with mitered joints 4-inch
and larger)

6B (4) Polyvinyl Chloride (PVC)
Schedule 40 and 80 SDR 21 and
SDR 26 (6-inch and larger) D2241

6B (5) Corrugated Poly-vinyl
Chloride (PVC) Schedule 40 (4-
to 36-inch) with ASTM D3212
fittings (Storm only) F949

BUILDING SEWER

6C (1) Styrene -- Rubber D2852 CS228

6C (2) Polyvinyl Chloride (PVC) D3034 WW-P-00380a CSA-B182.2
F789
(18- to 27-inch only) F679
(18-inch and larger) F794

6C (3) Acrylonitrile-
Butadiene-Styrene (ABS) D2751 CSA-B182.1

6C (4) Corrugated High Density
Polyethylene (Corrugated
HDPE) (4- to 60-inch) with
ASTM D3212 fittings (Storm
only) 4- to 10-inch
AASHTO
M252
12- to 60-inch
ASTM F2306

WATER SERVICE - Minimum working pressure rating shall be at least 150 psi for municipal water service and 100 psi for other service.

6D Polyethylene (PE) B72.1 D2239 LP-315a NSF14
D2737 FHA-UM-31C CS255
CSA-B137.1

6E Acrylonitrile- B72.3 D2282 NSF14
Butadiene-Styrene
(ABS) CS254

6F Polyvinyl Chloride B72.2 D2241 L-P-1036 NSF14
(PVC) D1785 FHA UM-41 CS256
CSA-B137.3

MINNESOTA RULES 2011

4715.0420 PLUMBING CODE

846

6G	Polybutylene	D2662 D2666	NSF14 CSA-B137.7
6I	Polyethylene/Aluminum/ Polyethylene (PE-AL-PE) Composite Pressure Pipe (up to 1 inch only)	F1282	NSF 14 NSF 61

WATER DISTRIBUTION - Polybutylene (PB) systems (PB tubing together with recommended fittings) and chlorinated polyvinyl chloride (CPVC) pipe together with fittings must be tested by the manufacturer at 150 psi and 210 degrees Fahrenheit for a period of not less than 48 hours by a qualified independent testing laboratory acceptable to the administrative authority. Cross-linked polyethylene (PEX) tubing systems together with approved fittings must be tested at 150 psi and 210 degrees Fahrenheit for a period of not less than 30 days by a qualified independent testing laboratory acceptable to the administrative authority.

Polypropylene (PP-R) pipe together with fittings must be tested by the manufacturer at 510 psi hoop stress and 203 degrees Fahrenheit for a period of not less than 40 days by a qualified independent testing laboratory acceptable to the administrative authority.

6K	Polybutylene	D3309	CSA-B137.8 (tubing)
6L	Chlorinated Polyvinyl Chloride (CPVC), Schedule 80 (2-1/2 to 6 inches)	119.1, 119.2 D2846 F441 F442	NSF14 FHA Bulletin #76 CSA-B137.6
6M	Cross-linked Polyethylene (PEX) Tubing	F876	NSF 14 NSF 61
6N	(1) Metal Insert Fittings Utilizing a Copper Crimp Ring for PEX Tubing	F1807	NSF 14 NSF 61
6N	(2) Cold Expansion Fittings with PEX Reinforcing Rings for Use with PEX Tubing	F1960	NSF 14 NSF 61
6N	(3) Cold Expansion Fittings with Metal Compressions Sleeves for Use with PEX Tubing	F2080	NSF 14 NSF 61

MINNESOTA RULES 2011

847 **PLUMBING CODE 4715.0420**

6N	(4) Stainless Steel Clamps for Securing PEX Tubing to Metal Insert Fittings	F2098-01		NSF 14 NSF 61
6N	(5) Plastic Insert Fittings Utilizing a Copper Crimp Ring for PEX Tubing	F2159		NSF 14 NSF 61
6N	(6) Cross-linked Polyethylene (PEX) Plastic Hot and Cold Water Distribution Systems	F877		NSF 14 NSF 61
6P	Polypropylene (PP-R) SPECIAL WASTES	F2389		NSF 14 NSF 61
6S	Polyethylene	F1412	LP 315a	PS10-69 PS11-69 PS12-69
6T	Polypropylene	F1412		
6U	Polyvinylidene Fluoride (PVDF)	F1673		
6V	Chlorinated Polyvinyl Chloride (CPVC) GENERAL DRAINAGE			IAPMO IGC 210-2005a
6W	Polyethylene (corrugated)	F405		
VII.	FIBERGLASS PIPE AND FITTINGS			
7A	Fiberglass pipe (reinforced thermosetting resin pipe) (one- to 16-inch) (18- to 48-inch must be manufactured in accordance with ASTM D2996)	D2996		NSF14 NSF61 AWWA C-950

Statutory Authority: *MS s 16B.59 to 16B.75; 326.37 to 326.45; 326B.101 to 326B.194; 326B.43 to 326B.49*

History: *9 SR 1557; 11 SR 1405; 15 SR 76; 19 SR 590; 23 SR 686; 28 SR 146; L 2007 c 140 art 4 s 61; art 6 s 15; art 13 s 4; L 2008 c 337 s 64; 33 SR 2042*

PIPING SYSTEM MATERIALS

4715.0500 WATER SUPPLY SYSTEMS.

When selecting the material and size for water service pipe, tubing, or fittings, due consideration shall be given to the action of the water on the interior of the pipe and of the soil, fill, or other material on the exterior of the pipe.

Pipe and fitting materials for water service and distribution must be of a type specifically permitted by parts 4715.0510 and 4715.0520, and must be verified to contain no more than eight percent lead.

Statutory Authority: *MS s 16B.61; 326.37 to 326.45; 326B.106; 326B.43 to 326B.49*

History: *15 SR 76; L 2007 c 140 art 4 s 61; art 6 s 15; art 13 s 4*

4715.0510 WATER SERVICE PIPE.

The following materials may be used for water service pipe:

A. Cast iron pipe 1C and 1D both with 1E fittings with the provisions that bends, tees, and plugs shall be anchored by rods. Poured in place concrete thrust blocks or anchor rods shall be used behind all changes of direction of 45 degrees or greater so as to maintain a water tight joint.

B. Steel pipe 2A, wrought iron pipe 2B, both with 2D and 2E fittings, with the provision that all exposed threads must be coal tar enamel coated and wrapped.

C. Red brass pipe 3A, and copper 3L, with 3C fittings, with the provision that every joint is supported by durable nonmetallic support and pipe to be laid on a continuous granular bed.

D. Copper tube 3E or 3G and 3D or 3N fittings.

E. Asbestos cement pipe 5A and fittings with the provision that this material be supported continuously and laid in granular soil and only in yard areas. Further that it not be used to convey extremely soft water, and shall pass through the floor within three feet of the outside wall.

F. Concrete pipe 5N.

G. Plastic pipe 6D, 6E, 6F, 6G, and 6I may be used for water service pipe only up to the water meter or pressure tank and provided there is no more than two feet of such piping exposed within the building. These materials shall be installed in accordance with ASTM D 2774-72. Particular care shall be taken to avoid sharp edges in contact with the pipe and to provide for expansion and contraction. Plastic pipe 6I must be installed in accordance with the manufacturer's installation instructions.

H. Ductile iron pipe 1L and 1M.

I. Fiberglass pipe 7A. Installation must be in accordance with the manufacturer's requirements, recommendations, and guidelines.

Statutory Authority: *MS s 16B.59 to 16B.75; 326.37 to 326.45; 326B.101 to 326B.194; 326B.43 to 326B.49*

History: *9 SR 1557; 11 SR 1405; 19 SR 590; 23 SR 686; L 2007 c 140 art 4 s 61; art 6 s 15; art 13 s 4; L 2008 c 337 s 64; 33 SR 2042*

4715.0520 WATER DISTRIBUTION PIPE.

The following materials may be used for water distribution pipe:

A. Cast iron with 1C and 1D fittings.

B. Steel pipe 2A and wrought iron 2B with 2D and 2E fittings with the provision that this material may not be laid underground nor embedded in masonry construction unless all threads are coal tar enamel coated and wrapped.

C. Steel pipe 2C(a), stainless.

D. Brass 3A pipe or tube 3B with 3C fittings.

E. Copper tube 3E or 3G with 3N wrought fittings or 3D fittings with provisions that it be installed to allow for expansion or contraction and that all stubs through concrete floors must be sleeved or protected by resilient material.

F. Copper tube 3H, 194 water tube 3H(a), or stainless water tubing 3H(b) with 3N fittings except that this material may not be buried under or embedded in a concrete slab.

G. Copper 3J, 194 water tube 3J(a), stainless steel water tubing 3J(b), copper alloy 3P, or welded brass 3Q with 3N fittings may be installed exposed or in frame partitions, or in tunnels and shafts, except that this material may not be laid underground or embedded in masonry or concrete.

H. Copper 3L and 3C fittings.

I. Copper 3M with fittings.

J. Plastic tubing 6K with fittings. Installation must be in accordance with International Association of Plumbing and Mechanical Officials (IAPMO) Installation Standard 22-84.

K. Plastic pipe 6L and corresponding fittings. Installation must be in accordance with International Association of Plumbing and Mechanical Officials (IAPMO) Installation Standards 20-98; however, this material may be air tested.

L. Cross-linked polyethylene (PEX) tubing 6M with fittings 6N(1), 6N(2), 6N(3), 6N(4), 6N(5), or 6N(6) shall be certified by an independent third-party certifier. The water distribution system shall be installed by a factory-trained installer in accordance with the manufacturer's installation instructions. Tubing and fittings must be marked with the appropriate ASTM designations by the manufacturer.

M. Fiberglass pipe 7A. Installation must be in accordance with the manufacturer's requirements, recommendations, and guidelines.

N. Polypropylene (PP-R) pipe 6P shall be certified by an independent third-party certifier. The water distribution system shall be installed by a factory-trained installer in accordance with the manufacturer's installation instructions.

Statutory Authority: *MS s 16B.59 to 16B.75; 326.37 to 326.45; 326B.101 to 326B.194; 326B.43 to 326B.49*

History: *9 SR 1557; 11 SR 1405; 15 SR 76; 23 SR 686; 28 SR 146; L 2007 c 140 art 4 s 61; art 6 s 15; art 13 s 4; L 2008 c 337 s 64; 33 SR 2042*

4715.0530 BUILDING SEWERS.

The following materials may be used for building sewers:

A. Cast Iron 1A and 1B and fittings and Hubless Cast Iron 1K.

B. Cast Iron 1C and 1D with 1E fittings.

C. Asbestos cement 5A and 5C and fittings laid on a continuous granular bed.

D. Clay pipe and fittings 5E laid on a continuous granular bed.

E. Concrete pipe 5K in yard areas and not under permanent streets, laid on a continuous granular bed.

F. Concrete 5M and 5N and fittings.

G. Plastic 6A, 6B(1), 6B(3), 6B(4), 6C(1), 6C(2), and 6C(3) and corresponding fittings must be laid on a continuous granular bed. Installation must comply with ASTM D2321.

H. Bituminized-fiber drain and sewer pipe 5O, laid on a continuous granular bed.

I. Fiberglass pipe 7A for pressure sewers. Installation must be in accordance with the manufacturer's requirements, recommendations, and guidelines.

4715.0530 PLUMBING CODE

850

J. Ductile Iron 1L and 1M. Gravity installation must be from manhole to manhole or building to manhole with no change in direction, and must be in accordance with ASTM A746-03 and the manufacturer's recommendations and requirements.

Statutory Authority: *MS s 16B.59 to 16B.75; 326.37 to 326.45; 326B.101 to 326B.194; 326B.43 to 326B.49*

History: *9 SR 1557; 23 SR 686; L 2007 c 140 art 4 s 61; art 6 s 15; art 13 s 4; L 2008 c 337 s 64; 33 SR 2042*

4715.0540 STORM WATER AND YARD DRAINAGE (OUTSIDE FOUNDATION WALLS).

For storm water and yard drainage outside foundation walls the following materials may be used:

- A. those materials specified in part 4715.0530;
- B. corrugated, aluminized steel 2F. This material may not be used in any area requiring testing in accordance with part 4715.2820. Installation must comply with ASTM A798;
- C. corrugated high density polyethylene 6C(4) and approved joints. Installation must comply with ASTM D2321; and
- D. corrugated plastic 6B(5). Installation must comply with ASTM D2321.

Statutory Authority: *MS s 16B.59 to 16B.75; 326.37 to 326.45; 326B.101 to 326B.194; 326B.43 to 326B.49*

History: *23 SR 686; 28 SR 146; L 2007 c 140 art 4 s 61; art 6 s 15; art 13 s 4; L 2008 c 337 s 64*

4715.0550 STORM WATER OR CLEAR WATER DRAINAGE (WITHIN BUILDINGS UNDERGROUND).

For storm water or clear water drainage within buildings underground:

- A. Approved materials shall be as specified in part 4715.0570 with the following addition.
- B. Concrete 5M and 5N and fittings.

Statutory Authority: *MS s 326.37 to 326.45; 326B.43 to 326B.49*

History: *L 2007 c 140 art 6 s 15; art 13 s 4*

4715.0560 STORM WATER OR CLEAR WATER DRAINAGE (WITHIN BUILDINGS ABOVE GROUND).

For storm water or clear water drainage within buildings above ground, materials shall be as specified in part 4715.0580.

Statutory Authority: *MS s 326.37 to 326.45; 326B.43 to 326B.49*

History: *L 2007 c 140 art 6 s 15; art 13 s 4*

4715.0570 SOIL AND WASTE PIPING UNDERGROUND OR EMBEDDED.

For soil and waste piping, except special wastes, underground or embedded in masonry construction the following materials may be used:

- A. Cast iron 1A or 1B and fittings, and hubless cast iron 1K;
- B. Cast iron 1C or 1D with 1E fittings;
- C. Steel pipe 2C(b), stainless;
- D. Lead 4A pipe with wiped joints, fittings 4C; and

E. Plastic 6A, 6B(1), 6B(2), 6B(3), or 6B(4) and corresponding fittings must be laid on a continuous granular bed. Installation must comply with ASTM D2321.

Statutory Authority: *MS s 16B.59 to 16B.75; 326.37 to 326.45; 326B.101 to 326B.194; 326B.43 to 326B.49*

History: *9 SR 1557; 23 SR 686; L 2007 c 140 art 4 s 61; art 6 s 15; art 13 s 4; L 2008 c 337 s 64*

4715.0580 SOIL AND WASTE PIPING ABOVE GROUND.

For soil and waste piping, except special wastes, above ground, the following materials may be used:

A. Cast iron 1A and 1B and fittings, and hubless cast iron 1K. This pipe may be uncoated above ground.

B. Cast iron 1F with 1J fittings.

C. Steel pipe 2A, wrought iron 2B with 1J fittings, and stainless 2C(b).

D. Copper 3F, 3H, 3J (hard temper only), and 3K with 3O fittings except these materials shall not be used to receive the wastes from urinals nor wastes from water closets in battery. These materials are not recommended for use in buildings served by septic tank sewage disposal systems.

E. Lead 4A with wiped joints and fittings 4C.

F. Plastic 6A, 6B(1), 6B(2), 6B(3), or 6B(4) with corresponding fittings may be installed except that no horizontal drain may exceed 35 feet in total length. No stack may exceed 35 feet in total height unless an approved expansion and contraction joint is installed at intervals not to exceed 35 feet.

Statutory Authority: *MS s 16B.59 to 16B.75; 326.37 to 326.45; 326B.101 to 326B.194; 326B.43 to 326B.49*

History: *9 SR 1557; 15 SR 76; 23 SR 686; L 2007 c 140 art 4 s 61; art 6 s 15; art 13 s 4; L 2008 c 337 s 64*

4715.0590 VENT PIPING BELOW GROUND.

For vent piping below ground, the following materials may be used:

A. Cast iron 1A and 1B and fittings, and hubless cast iron 1K;

B. Cast iron 1F with fittings and with 1H fitting;

C. Steel pipe 2C(b), stainless;

D. Brass 3A or 3B with 3C fittings;

E. Copper 3F or 3B with 3C fittings;

F. Copper 3L with 3C fittings;

G. Copper 3M with fittings; and

H. Plastic 6A, 6B(1), 6B(2), 6B(3), or 6B(4) with corresponding fittings.

Statutory Authority: *MS s 16B.59 to 16B.75; 326.37 to 326.45; 326B.101 to 326B.194; 326B.43 to 326B.49*

History: *9 SR 1557; 23 SR 686; L 2007 c 140 art 4 s 61; art 6 s 15; art 13 s 4; L 2008 c 337 s 64*

4715.0600 VENT PIPING ABOVE GROUND.

For vent piping above ground, the following materials may be used:

A. Cast iron 1A and 1B and fittings, and hubless cast iron 1K (pipe may be uncoated);

B. Cast iron 1F with 1H fitting;

C. Steel 2A pipe, wrought iron 2B with 1H fitting, and stainless 2C(b);

4715.0600 PLUMBING CODE

852

- D. Brass 3A or 3B with 3C fittings;
- E. Copper 3F, 3H, 3J, and 3K, with 3N or 3O fittings, except see part 4715.0580, item D;
- F. Copper pipe 3L with 3C fittings;
- G. Copper pipe 3M with 3M fittings; and
- H. Plastic 6A, 6B(1), 6B(2), 6B(3), or 6B(4) with corresponding fittings may be installed except that no horizontal vent may exceed 35 feet in total length.

No vent stack or stack vent may exceed 35 feet in total height unless an approved expansion and contraction joint is installed at intervals not to exceed 35 feet.

Statutory Authority: *MS s 16B.59 to 16B.75; 326.37 to 326.45; 326B.101 to 326B.194; 326B.43 to 326B.49*

History: *9 SR 1557; 23 SR 686; L 2007 c 140 art 4 s 61; art 6 s 15; art 13 s 4; L 2008 c 337 s 64*

4715.0610 SPECIAL WASTES.

For special wastes, the following materials may be used:

A. The following corrosion resistant materials are acceptable for chemical waste and vent systems: stainless steel 2C(b), chemically resistant glass pipe 5H, high silicon content cast iron 1G, and chemically resistant plastic pipe 6S, 6T, 6U, or 6V. The installation shall be in accordance with manufacturer's installation instructions. If 6S, 6T, 6U, or 6V is used, horizontal piping may not exceed 35 feet in total length; and stacks may not exceed 35 feet in total height unless an approved expansion and contraction joint is installed at intervals not to exceed 35 feet. Underground installation of chemically resistant plastic pipe shall comply with ASTM D2321.

B. Pressure wastes or nonpressure wastes which are completely exposed or accessible, and which discharge indirectly to the drainage system may be of any materials in part 4715.0420, subpart 3, with due regard to the type of liquid being wasted.

Statutory Authority: *MS s 16B.59 to 16B.75; 326.37 to 326.45; 326B.101 to 326B.194; 326B.43 to 326B.49*

History: *9 SR 1557; 23 SR 686; 28 SR 146; L 2007 c 140 art 4 s 61; art 6 s 15; art 13 s 4; L 2008 c 337 s 64; 33 SR 2042*

4715.0620 SUBSOIL DRAINS.

All materials listed in part 4715.0570 plus asbestos cement 5D, clay 5G, cement 5J, and cement 5L, perforated bituminized fiber pipe for general drainage 5P, and plastic 6A, 6B, 6C, and 6W, may be used for subsoil drains.

Statutory Authority: *MS s 16B.59; 16B.61; 16B.64; 326.37 to 326.45; 326B.101; 326B.106; 326B.13; 326B.43 to 326B.49*

History: *15 SR 76; 28 SR 146; L 2007 c 140 art 4 s 61; art 6 s 15; art 13 s 4*

4715.0630 SPECIAL MATERIALS.

Subpart 1. **Sheet lead.** Sheet lead for the following uses shall weigh not less than:

- A. general use, four pounds per square foot;
- B. safe pans, four pounds per square foot; and
- C. flashings for vent pipes, three pounds per square foot.

Subp. 2. **Lead bends and traps.** The walls of lead bends and traps shall be at least one-eighth inch thick.

Subp. 3. **Sheet copper.** Sheet copper for the following uses shall weigh not less than:

- A. general use, 12 ounces per square foot; and
- B. flashing for vent pipes, eight ounces per square foot.

Subp. 4. **Floor flanges.** Floor flanges for water closets or similar fixtures shall be not less than one-eighth inch thick for brass; one-fourth inch thick and not less than two inch caulking depth for cast iron or galvanized malleable iron.

If of hard lead, they shall weigh not less than one pound nine ounces, and be composed of lead alloy with not less than 7.75 percent antimony by weight. Flanges shall be soldered or threaded into other metal. Closet screws and bolts shall be of noncorrodible material.

Subp. 5. **Flush pipes and fittings.** Flush pipes and fittings shall be of nonferrous material. When of brass or copper tubing, the material shall be not less than No. 20 U.S. gauge.

Subp. 6. **Brass tubing traps and trap arms.** All brass tubing used for traps and trap arms shall be not less than 17 gauge (.045 inches) in thickness. Nuts used with brass tubing shall be of brass or other noncorrodible material.

Subp. 7. **Plastic tubular traps, plastic (ABS and PVC) tube and tubular fittings for waste connections.** All tubular fittings must comply with the requirements of ASTM Standard F 409.

Statutory Authority: *MS s 326.37 to 326.45; 326B.43 to 326B.49*

History: *L 2007 c 140 art 6 s 15; art 13 s 4*

4715.0640 FIXTURE MATERIALS.

Plumbing fixtures shall have smooth, impervious surfaces, be free from defects and concealed surfaces. All receptacles used as water closets, urinals, or otherwise, for the disposal of human excreta, shall be vitreous china, or other material acceptable to the administrative authority, except trough urinals may be cast iron, enameled on the inside. Drinking fountains shall be constructed of impervious nonoxidizing material and shall be so designed that they may be easily cleaned. Plumbing fixtures shall conform to the applicable commercial standards, where such standards exist.

Statutory Authority: *MS s 326.37 to 326.45; 326B.43 to 326B.49*

History: *L 2007 c 140 art 6 s 15; art 13 s 4*

JOINTS AND CONNECTIONS

4715.0700 TIGHTNESS.

Joints and connections in the plumbing system shall be gastight and watertight for the pressure required by test, with the exception of those portions of perforated or open joint piping which are installed for the purpose of collecting and conveying ground or seepage water. Portions of storm sewers that do not require testing as provided in part 4715.2820 must be constructed with a code-approved type of pipe and joint that has been certified by the manufacturer to be able to pass the air test specified in part 4715.2820, or an internal hydrostatic pressure of ten pounds per square inch for ten minutes with no leakage.

Statutory Authority: *MS s 16B.59 to 16B.75; 326.37 to 326.45; 326B.101 to 326B.194; 326B.43 to 326B.49*

History: *23 SR 686; L 2007 c 140 art 4 s 61; art 6 s 15; art 13 s 4; L 2008 c 337 s 64*

TYPES OF JOINTS FOR PIPING MATERIAL

4715.0710 ASBESTOS CEMENT SEWER PIPE JOINTS.

Joints in asbestos cement pipe shall be made with sleeve couplings of the same composition as the pipe, sealed with rubber rings. Joints between asbestos cement pipe and metal pipe shall be made by means of an adapter coupling caulked as required in part 4715.0740. No adapted coupling shall be used that does not have a center ridge. Pipe must not be able to pass through the coupling.

Statutory Authority: *MS s 326.37 to 326.45; 326B.43 to 326B.49*

History: *L 2007 c 140 art 6 s 15; art 13 s 4*

4715.0720 PLUMBING CODE

854

4715.0720 BITUMINIZED FIBER DRAIN PIPE JOINT.

Pipe and bends shall be provided with accurately machined or molded tapered joints, and a taper sleeve coupling shall be provided for each length of pipe and for each bend. The slope of the taper in both pipe and coupling shall be two degrees.

Statutory Authority: *MS s 326.37 to 326.45; 326B.43 to 326B.49*

History: *L 2007 c 140 art 6 s 15; art 13 s 4*

4715.0730 BURNED LEAD JOINTS.

Burned (welded) lead joints shall be fused together to form a uniform weld at least as thick as the lead being joined.

Statutory Authority: *MS s 326.37 to 326.45; 326B.43 to 326B.49*

History: *L 2007 c 140 art 6 s 15; art 13 s 4*

4715.0740 CAULKED JOINTS.

Caulked joints for cast-iron bell and spigot soil pipe shall be firmly packed with oakum or hemp and filled with molten lead not less than one inch deep and shall extend not more than one-eighth inch below rim of hub. No paint, varnish, or any other coatings shall be permitted on the jointing material until after the joint has been tested and approved. Lead shall be caulked tight.

Statutory Authority: *MS s 326.37 to 326.45; 326B.43 to 326B.49*

History: *L 2007 c 140 art 6 s 15; art 13 s 4*

4715.0750 CEMENT MORTAR JOINTS.

Except for repairs and connections of existing lines constructed with such joints, cement mortar joints are prohibited. Where permitted, cement mortar joints shall be made in the following manner: A layer of jute or hemp shall be inserted into the base of the annular joint space and packed tightly to prevent mortar from entering the interior of the pipe or fitting. Not more than 25 percent of the annular space shall be used for jute or hemp. The remaining space shall be filled in one continuous operation with a thoroughly mixed mortar composed of one part cement and two parts sand, with only sufficient water to make the mixture workable by hand. Additional mortar of the same composition shall then be applied to form a one to one slope with the barrel of the pipe. The bell or hub of the pipe shall be left exposed and when necessary the interior of the pipe shall be swabbed to remove any mortar or other material which may have found its way into such pipe.

Statutory Authority: *MS s 326.37 to 326.45; 326B.43 to 326B.49*

History: *L 2007 c 140 art 6 s 15; art 13 s 4*

4715.0760 COLD JOINT COMPOUND, TAR BASE.

Cold joint compound (tar base) for clay and concrete pipe shall not be water absorbent, and shall bond itself to vitrified clay and concrete pipe. Half of the joint must be packed with oakum, and the remainder with cold tar compound.

Statutory Authority: *MS s 326.37 to 326.45; 326B.43 to 326B.49*

History: *L 2007 c 140 art 6 s 15; art 13 s 4*

4715.0770 FLARED JOINTS.

Flared joints for soft copper water tubing shall be made with fittings meeting approved standards. (See part 4715.0420, subpart 3.) The tubing shall be reamed and expanded with proper flaring tools.

Statutory Authority: *MS s 326.37 to 326.45; 326B.43 to 326B.49*

History: *L 2007 c 140 art 6 s 15; art 13 s 4*

4715.0780 GASKET TYPE JOINTS.

Resilient rubber joints for clay or concrete: Flexible joints between lengths of clay or concrete pipe may be made by using approved resilient or rubber materials, both on the spigot end and in the bell end of the pipe.

Statutory Authority: *MS s 326.37 to 326.45; 326B.43 to 326B.49*

History: *L 2007 c 140 art 6 s 15; art 13 s 4*

4715.0790 HOT-POURED JOINTS.

Hot-poured compound for clay or concrete sewer pipe, or other materials, shall not be water-absorbent, and when poured against a dry surface shall have a bond of not less than 100 pounds per square inch. All surfaces of the joint shall be clean and dried before pouring. If wet surfaces are unavoidable, a suitable primer shall be applied.

The compound shall not soften sufficiently to destroy the effectiveness of the joint when subjected to a temperature of 160 degrees Fahrenheit nor soluble in any of the waste carried by the drainage system. Approximately 25 percent of the joint space at the base of the socket shall be filled with jute or hemp. A pouring collar, rope, or other device shall be used to hold the hot compound when pouring. Each joint shall be poured in one operation until the joint is filled. Joints shall not be tested until one hour after pouring.

Statutory Authority: *MS s 326.37 to 326.45; 326B.43 to 326B.49*

History: *L 2007 c 140 art 6 s 15; art 13 s 4*

4715.0800 MECHANICAL JOINTS.

Subpart 1. **Mechanical joints for cast iron and steel water pipe.** Mechanical joints in cast iron and steel water pipe must be made by means of a flanged collar and rubber ring gasket, secured by the use of an adequate number of steel bolts. The rubber sealing ring must conform to ANSI-A21.11 (AWWA-C11).

Subp. 2. **Mechanical joints in cast iron bell and spigot soil pipe.** Mechanical joints in cast iron soil pipe shall be made by means of a preformed molded rubber ring, secured by pulling the pipe and fittings together in such a way as to compress the molded rubber ring in a manner that will assure a gas and water tight joint. The rubber sealing ring shall conform to ASTM C 564 requirements.

Subp. 3. [Repealed by amendment, 9 SR 1557]

Subp. 4. **Mechanical joints in hubless cast iron soil pipe.** Mechanical joints for hubless cast iron soil pipe and fittings shall be made by using a neoprene sleeve and stainless steel retaining band as specified in CISPI standard 310, ASTM C 1277-06, or ASTM C 1540-04 and in accordance with the manufacturer's installation instructions, by using a transition fitting made of elastomeric material (ASTM C 425 and ASTM C 564) and 300 series stainless steel bands and bolts, or by using a two-part coupling whose housing is fabricated of grey-cast iron (ASTM A 48), with a coupling gasket made of neoprene rubber (ASTM C 564 or CSA/CAN 3-B70), and coupling bolts and nuts made of 18-8 stainless steel.

Subp. 5. **Mechanical pipe couplings and fittings.** Couplings must be made with the housing fabricated in two or more parts of ductile or malleable iron castings in accordance with Federal Specification QQ-I-666c, Grade 11, or with ASTM A47 or ASTM A339. The coupling gasket must be molded synthetic rubber, per ASTM D-735-61, Grade No. R615BZ. Coupling bolts must be oval neck track head type with hexagonal heavy nuts, per ASTM-A-183-60, or ASTM A325.

Pipe fittings used with these pipe couplings must be fabricated or malleable iron castings in accordance with Federal Specifications QQ-I-666c, Grade 11, or with ASTM A47; ductile iron ASTM A339; segweld steel ASTM53 or A106; or IAPMO-approved copper fittings with rolled grooves intended to be used together with copper tubing with cold rolled grooved ends.

These couplings and fittings may be used above ground, for storm drains and leaders, and for water distribution pipe provided exposed parts in contact with water are galvanized, and may be used below ground for water distribution if couplings and fittings are galvanized and the exposed grooves are coal tar enamel coated and wrapped.

Saddle-type fittings secured by steel electroplated U-bolts may be used for above-ground water distribution, if the fittings are galvanized, include a collar fitting into the pipe opening with a gasket, and have IAPMO approval.

All grooving of galvanized pipe must be by the cut groove method.

Subp. 6. **Extracted mechanical joint.** An extracted mechanical joint in copper water distribution pipe must be made by drilling through copper pipe and on retraction must extract a cup shaped extruded collar. The height of the collar must be at least three times the thickness of the copper tube wall and the radius of the extruded collar must be the same thickness as the copper tube wall from which it is being extruded. The joining branch tube must be contour-notched and a retaining dimple must be made before insertion into the extracted collar or another acceptable method must be used to provide proper insertion depth. The joint must be brazed with a brazing material meeting the requirements of part 4715.0820. The joint may be used above ground only.

Subp. 6a. **Field formed coupling for copper tubing.** A field formed coupling in copper water distribution pipe must be made by first annealing the area of the tubing where expansion is desired, and then using a hand tube expander to expand the tube end to accept tubing of the same type and size. Joint clearances must be from .001 to .005 inches, and suitable for the brazing filler metal used. The depth of the expanded area must be as recommended by the tube expander manufacturer, but in all cases must be at least four times the wall thickness of the tubing. All joints must be brazed in accordance with the requirements of part 4715.0820. The couplings must be used above ground only.

Subp. 7. **Mechanical tee coupling for steel pipe.** Couplings utilizing an explosive charge and an internal cutting mechanism may be used to join galvanized steel pipe only. All portions of the coupling exposed to water must be of galvanized steel construction acceptable for contact with potable water. The coupling must only be used above ground and only in areas that are accessible. The coupling must be attached to the steel pipe by use of four allen screws which must be torqued in accordance with the coupling manufacturer's recommendation.

Statutory Authority: *MS s 16B.61; 16B.62; 326.37 to 326.45; 326B.106; 326B.121; 326B.43 to 326B.49*

History: *9 SR 1557; 15 SR 76; 19 SR 590; L 2007 c 140 art 4 s 61; art 6 s 15; art 13 s 4; 33 SR 2042*

4715.0805 PUSH-ON JOINTS.

Subpart 1. **Water service joints.** Push-on joints may be used in cast iron and ductile iron water service pipe located underground outside the building, and must comply with ANSI-A21.11-85. Lead-tipped gaskets are prohibited.

Subp. 2. **Water distribution joints.** Removable and nonremovable push-fit fittings that comply with ASSE 1061-2006 may be used in copper pipe water distribution for above-ground installation. The installer must be certified by the manufacturer to install that manufacturer's fitting.

Statutory Authority: *MS s 16B.61; 16B.62; 326.37; 326B.106; 326B.121; 326B.43*

History: *15 SR 76; 19 SR 590; L 2007 c 140 art 4 s 61; art 6 s 15; art 13 s 4; 33 SR 2042*

4715.0810 PLASTIC JOINTS.

Subpart 1. **Joint methods.** Every joint in plastic piping must be made with approved fittings using solvent welded connections, fusion welded connections, insert fittings with metal clamps and screws of corrosion-resistant material or approved crimp rings, threaded

joints according to accepted standards, or special IAPMO listed fittings of other types. Large diameter water service pipe may have approved elastomeric-gasket push-on type joints which comply with ASTM D 3139. All solvent materials must meet approved recognized standards. Expansion and contraction joint materials and dimensions must conform to ASTM D 2661 or ASTM D 2665 and shall be of an approved type. Gasketed sewer fittings must comply with ASTM F1336.

Subp. 2. **Primer.** Solvent weld joints in PVC and CPVC pipe must include use of a primer of contrasting color to the pipe and cement. Primers must comply with the National Sanitation Foundation (NSF) Standard Number 14. A mechanical method of preparing PVC or CPVC pipe for solvent cement is not acceptable in lieu of using a primer.

Exception: A one-step solvent cement complying with ASTM F493 and ASTM D2846 may be used for CPVC pipe.

Subp. 3. **Fusion welding.** Fusion-weld connections in polypropylene pipe shall include socket-fusion, butt-fusion, electro-fusion, and fusion outlet branch fittings. Fusion welding shall be in accordance with ASTM F2389.

Statutory Authority: *MS s 16B.59 to 16B.75; 326.37 to 326.45; 326B.101 to 326B.194; 326B.43 to 326B.49*

History: *11 SR 1405; 15 SR 76; 19 SR 590; 23 SR 686; L 2007 c 140 art 4 s 61; art 6 s 15; art 13 s 4; L 2008 c 337 s 64; 33 SR 2042*

4715.0815 JOINTS IN CHEMICAL WASTE PIPE.

Joints for chemical waste and vent piping must be of corrosion resistant material, or coated or wrapped with a corrosion resistant material, and designed for use with the type of piping material selected. All joint materials and methods must be as approved by the administrative authority.

Statutory Authority: *MS s 326.37 to 326.45; 326B.43 to 326B.49*

History: *9 SR 1557; L 2007 c 140 art 6 s 15; art 13 s 4*

4715.0820 SOLDERED OR BRAZED JOINTS.

Joints with copper tube with solder joint fittings must be soldered or brazed. Copper tubing must be reamed out to the full interior tubing dimension before soldered or brazed joints are made. Surfaces to be soldered or brazed must be thoroughly cleaned. Joints to be soldered must be properly fluxed with noncorrosive paste or liquid type flux complying with ASTM Standard B813-00. Solder and flux used in potable water systems must not contain more than 0.2 percent lead. Solder used for joints must have a nominal composition of 50 percent tin and 50 percent lead, 95 percent tin and five percent antimony, or 96 percent tin and four percent silver, conforming to ASTM Standard Specification for soft solder metal B32-94, except that 50 percent tin and 50 percent lead solder must not be used in potable water systems. Alternative solders may be used if specifically approved by the administrative authority after review of testing laboratory or listing agency documentation. Brazing must be done using a brazing filler metal which is manufactured for the particular application, and using methods specified by the filler metal manufacturer.

Statutory Authority: *MS s 16B.59 to 16B.73; 326.37 to 326.45; 326B.101 to 326B.151; 326B.43 to 326B.49*

History: *11 SR 1405; 15 SR 76; 28 SR 146; L 2007 c 140 art 4 s 61; art 6 s 15; art 13 s 4; L 2008 c 337 s 64*

4715.0830 THREADED JOINTS -- SCREWED JOINTS.

Threaded joints shall conform to American National taper pipe thread, ASA B2.1-1945 or FS GGG-P-351a. All burrs shall be removed. Pipe ends shall be reamed out to size of bore and chips removed. Pipe joint compound shall be used on male threads only.

Statutory Authority: *MS s 326.37 to 326.45; 326B.43 to 326B.49*

History: *L 2007 c 140 art 6 s 15; art 13 s 4*

4715.0840 WIPED JOINTS.

Joints in lead pipe or fittings, or between lead pipe or fittings and brass or copper pipe, ferrules, solder nipples, or traps, shall be full wiped joints. Wiped joints shall have an exposed surface on each side of the joint not less than three-fourths inch, and a minimum thickness at the thickest part of the joint of not less than three-eighths inch. Joints between lead pipe and cast iron, steel, or wrought iron shall be made by means of a caulking ferrule, soldering nipple, or bushing.

Statutory Authority: *MS s 326.37 to 326.45; 326B.43 to 326B.49*

History: *L 2007 c 140 art 6 s 15; art 13 s 4*

4715.0850 USE OF JOINTS.

Subpart 1. **Bituminized fiber pipe joints.** Joints in bituminized fiber pipe shall be made as provided for in part 4715.0720.

Subp. 2. **Cast-iron pipe.** Joints in cast iron shall be either caulked or screwed, as provided in parts 4715.0740, 4715.0830, and 4715.0840.

Subp. 3. **Cast-iron soil pipe.** Joints in cast-iron soil pipe may be made by means as provided in part 4715.0740 or 4715.0800, subpart 2.

Subp. 4. **Clay sewer pipe.** Joints in clay sewer pipe, or between such pipe and metal pipe shall be made as provided in parts 4715.0750, 4715.0760, 4715.0780, and 4715.0790.

Subp. 5. **Concrete sewer pipe.** Joints in concrete sewer pipe, or between pipe and metal pipe, shall be made by means as provided in parts 4715.0750, 4715.0760, 4715.0780, and 4715.0790.

Subp. 6. **Copper water tube.** Joints in copper water tubing shall be made either by the appropriate use of approved brass or wrought copper water fittings properly soldered or brazed; by means of approved flared fittings as provided in part 4715.0770; by means of press type copper and copper alloy fittings on aboveground water distribution copper tubing, sizes 1/2-inch to 4-inch, installed in accordance with IAPMO Standard PS 117-2002; or by means of push-fit fittings for aboveground water distribution, installed in accordance with ASSE 1061-2006, which must not be embedded in concrete.

Subp. 7. **Lead to cast iron, wrought iron and steel.** Joints between lead and cast iron, wrought iron, or steel shall be made by means of wiped joints to a caulking ferrule, soldering nipple, or bushing as provided in part 4715.0840.

Subp. 8. **Plastic pipe joints.** Joints in plastic pipe or between plastic and cast iron, steel, brass, or copper pipe shall be made as provided in part 4715.0810.

Subp. 9. **Threaded pipe to cast iron.** Every joint between wrought iron, steel, brass, copper, and cast-iron pipe shall be either caulked or threaded joints as provided in parts 4715.0740, 4715.0830, and 4715.0840 and shall be made with approved adapter fittings.

Statutory Authority: *MS s 16B.59; 16B.61; 16B.64; 326.37 to 326.45; 326B.101; 326B.106; 326B.13; 326B.43 to 326B.49*

History: *28 SR 146; L 2007 c 140 art 4 s 61; art 6 s 15; art 13 s 4; 33 SR 2042*

4715.0860 SPECIAL JOINTS.

Subpart 1. **Bituminized fiber to other types of pipe.** When connecting bituminized fiber pipe to other types of materials, only approved types of fittings and adapters designed for the specific transition intended shall be used.

Subp. 2. **Cast-iron to copper tube.** Caulked joints between copper tubing and cast-iron soil pipe shall be made by means of brass or copper ferrules or other approved adapter fittings.

Subp. 3. **Copper tubing to threaded pipe joints.** Joints from copper tubing to threaded pipe shall be made by the use of brass or copper adapter fittings. The joint between the copper pipe and fitting shall be properly soldered, brazed, or flared.

Subp. 4. **Expansion joints.** Every expansion joint shall be of an approved type and the material used in its manufacture shall be compatible with the type of piping in which it is installed. Every expansion joint, other than an expansion loop, shall be accessible. (Also see part 4715.2770)

Subp. 5. **Slip joints.** In drainage piping, slip joints shall be used only on the inlet side of the trap or in the trap seal. Every slip joint shall be made using approved packings of gasket material or approved ground joint brass compression rings. Ground faced connections which allow adjustments of tubing but provide a durable rigid joint when made up shall not be considered as a slip joint.

Subp. 6. **Transition couplings.** A transition coupling is one which is to be used when pipes made of different materials are to be joined. A transition coupling may be made of elastomeric materials (ASTM C 425 and ASTM C 564) and 300 series stainless steel bands and bolts, except that an exterior corrosion-resistant shield to prevent outward expansion of the coupling must be included on above-ground installations. Any transition coupling joining plastic to plastic, copper to copper, or galvanized to galvanized, must be approved by the administrative authority.

Subp. 7. **Flexible joints for roof drain connections.** A flexible bellows-type joint may be used to join roof drains to approved storm drain piping. The flexible joint must be made of a bellowed neoprene or thermoplastic rubber sleeve and secured by 300 series stainless steel band and bolts. The joint must not be concealed nor installed at an angle of more than 45 degrees from the vertical.

Statutory Authority: *MS s 16B.61; 326.37 to 326.45; 326B.106; 326B.43 to 326B.49*

History: *9 SR 1557; 15 SR 76; L 2007 c 140 art 4 s 61; art 6 s 15; art 13 s 4*

4715.0870 FLANGED FIXTURE CONNECTIONS.

Fixture connections between drainage pipes and water closets, pedestal urinals, and earthenware trap standards shall be made by means of brass, plastic, or iron flanges, caulked, soldered, solvent welded, or screwed to the drainage pipe in accordance with the manufacturer's recommendations and approved by the administrative authority. The connection shall be bolted, with an approved gasket, washer, or setting compound between the earthenware and the connection. Floor flanges of other equivalent materials may be used when approved by the administrative authority.

The bottom of the floor flange shall be set on the top of the finished floor or on a structurally firm base. Closet bends or stubs must be cut off so as to present a smooth surface, even with the top of the closet flange. Use of commercial putty or plastic as fixture setting compound is prohibited.

Statutory Authority: *MS s 16B.62; 326.37 to 326.45; 326B.121; 326B.43 to 326B.49*

History: *19 SR 590; L 2007 c 140 art 4 s 61; art 6 s 15; art 13 s 4*

4715.0880 PROHIBITED JOINTS AND CONNECTIONS.

See part 4715.2420.

Statutory Authority: *MS s 326.37 to 326.45; 326B.43 to 326B.49*

History: *L 2007 c 140 art 6 s 15; art 13 s 4*

4715.0890 INCREASERS AND REDUCERS.

Brass or cast-iron body cleanouts shall not be used as a reducer or adapter from cast-iron soil pipe to steel or wrought iron pipe. Where different sizes of pipe or pipes and fittings are to be connected, the proper size increasers, reducers, or reducing fittings shall be used between the two sizes. Hexagon screwed bushings shall not be used in drainage piping.

Statutory Authority: *MS s 326.37 to 326.45; 326B.43 to 326B.49*

History: *L 2007 c 140 art 6 s 15; art 13 s 4*

TRAPS AND CLEANOUTS

4715.0900 FIXTURE TRAP REQUIREMENTS.

Each plumbing fixture, except those having an integral trap, shall be separately trapped by a water seal trap, installed as close to the fixture as possible, and in such a manner as to be readily accessible for cleaning and repairing.

A single trap may serve a two or three compartment sink or laundry tray. The trap shall be located not more than 30 inches horizontally from each compartment outlet. The vertical distance between the fixture outlet and the trap weir shall be as short as possible, but in no case more than 24 inches in length.

No food waste disposal unit shall be installed in a set of restaurant, commercial, or industrial sinks, served by a single trap. Each such disposal unit shall be individually trapped and connected to a separate waste opening. Each trap shall have the manufacturer's name or identification stamped legibly thereon and each tubing trap shall show the gauge of the tubing used in its manufacture.

Statutory Authority: *MS s 326.37 to 326.45; 326B.43 to 326B.49*

History: *L 2007 c 140 art 6 s 15; art 13 s 4; 33 SR 2042*

4715.0910 TRAPS DESCRIBED.

Every fixture trap shall be self-cleaning. Traps for bathtubs, lavatories, sinks, showers, laundry tubs, urinals, drinking fountains, and similar fixtures, shall be of standard design and weight and shall be of lead, brass, cast iron, or other approved materials, and have a smooth and uniform interior waterway.

Statutory Authority: *MS s 326.37 to 326.45; 326B.43 to 326B.49*

History: *L 2007 c 140 art 6 s 15; art 13 s 4*

4715.0920 TRAP PROTECTION.

All fixture traps, except as otherwise provided in this code, shall be protected against siphonage and back pressure by means of a properly installed vent pipe. The vent shall be so located that the developed length from the fixture trap to the vent shall not exceed the distance given in part 4715.2620, subpart 4.

The vent pipe opening from a soil or waste pipe, except for water closets and similar fixtures, shall not be below the weir of the trap. The trap arm direction may be changed by the use of not more than two 45 degrees or one 90 degrees long turn elbows.

Statutory Authority: *MS s 326.37 to 326.45; 326B.43 to 326B.49*

History: *L 2007 c 140 art 6 s 15; art 13 s 4*

4715.0930 SIZES OF TRAPS.

The minimum size (nominal interior diameter) of a trap for a given fixture shall be determined by part 4715.2300, subpart 3.

Statutory Authority: *MS s 326.37 to 326.45; 326B.43 to 326B.49*

History: *L 2007 c 140 art 6 s 15; art 13 s 4*

4715.0940 SLIP JOINTS AND UNIONS.

Union joints on the sewer side of the trap shall be ground faced, shall be accessible, and shall provide a rigid connection when made up tight. Slip joints shall be used only on the inlet side of the trap or in the trap seal.

Statutory Authority: *MS s 326.37 to 326.45; 326B.43 to 326B.49*

History: *L 2007 c 140 art 6 s 15; art 13 s 4*

4715.0950 TRAP SEALS.

Fixture traps shall have a water seal depth of not less than two inches and not more than four inches, except where, under special conditions, a trap with a deeper seal may be found necessary by the administrative authority.

The horizontal length of the seal of any fixture trap shall not exceed six inches where the waste pipe required is two inches or less in diameter.

Traps shall be set true and level with respect to their water seals and where necessary shall be protected from freezing.

Statutory Authority: *MS s 14.389; 326.37 to 326.45; 326B.43 to 326B.49*

History: *L 2007 c 140 art 6 s 15; art 13 s 4; 35 SR 1171*

NOTE: This part was amended effective July 5, 2011. When effective, this part will read:
"4715.0950 TRAP SEALS.

Fixture traps shall have a liquid seal depth of not less than two inches and not more than four inches, except where, under special conditions, a trap with a deeper seal may be found necessary by the administrative authority.

The horizontal length of the seal of any fixture trap shall not exceed six inches where the waste pipe required is two inches or less in diameter.

Traps shall be set true and level with respect to their liquid seals and where necessary shall be protected from freezing."

Statutory Authority: *MS s 14.389*

History: *35 SR 1171*

4715.0960 TRAPS PROHIBITED.

No form of trap which depends for its seal upon the action of movable parts or concealed interior partitions shall be used.

Full "S" traps, bell traps, and crown vented traps, are prohibited.

Traps shall not be made up with fittings, unless authorized by the administrative authority.

Water-cooled grease traps are prohibited.

No fixture shall be double-trapped.

Drum traps shall be installed only when permitted by the administrative authority for special conditions (laboratory tables, dental chairs, etc.).

Statutory Authority: *MS s 326.37 to 326.45; 326B.43 to 326B.49*

History: *L 2007 c 140 art 6 s 15; art 13 s 4*

4715.0970 TRAP CLEANOUTS.

An accessible trap is considered a cleanout for the fixture branch serving the individual fixture.

Statutory Authority: *MS s 326.37 to 326.45; 326B.43 to 326B.49*

History: *L 2007 c 140 art 6 s 15; art 13 s 4*

DRAINAGE PIPE CLEANOUTS**4715.1000 LOCATION.**

There shall be at least two cleanouts in the building drain, one at or near the base of the stack and one near the connection between the building drain and the building sewer. The cleanout at the outside wall may be inside or outside the building, and shall be made with a full "Y" branch fitting and shall extend at least two inches above grade or finished floor, except that the administrative authority may grant permission to use a flush cover in traffic areas.

A cleanout which is easily accessible shall be provided at or near the foot of each vertical soil or waste stack and each vertical storm water leader.

Each horizontal branch drain pipe shall be provided with a cleanout at its upper terminal, except that a fixture trap or a fixture with an integral trap, readily removable without disturbing concealed piping, may be accepted as a cleanout equivalent for this purpose.

4715.1000 PLUMBING CODE

862

All floor-set fixture drains with concealed traps such as floor drains, trench drains, and similar fixtures installed in areas receiving fouling waste shall be provided with an integral cleanout or a cleanout installed as close as possible to the fixture on the horizontal fixture branch serving the fixture. This cleanout shall be the same nominal pipe size as the horizontal fixture branch.

A floor drain cleanout may be omitted if the floor drain or fixture branch line is less than five feet in length.

Floor drains used for shower drains, recessed slop, or similar receptors may have the full-sized cleanout installed on the individual vent pipe serving the fixture or on the fixture.

A trap opening from a lavatory, drinking fountain, urinal, sink, or similar fixture may serve as a cleanout for a horizontal branch drain up to two inches in size, if the drain opening is not more than one pipe size smaller than the horizontal branch drain.

A cleanout shall be provided on a common vertical fixture drain or common vent serving two fixture traps that connect to a vertical drain at the same level. The cleanout shall be the same nominal pipe size as the drain serving the fixtures. Where the vertical drain is accessible through the trap opening, the cleanout may be eliminated.

Statutory Authority: *MS s 16B.59 to 16B.75; 326.37 to 326.45; 326B.101 to 326B.194; 326B.43 to 326B.49*

History: *23 SR 686; L 2007 c 140 art 4 s 61; art 6 s 15; art 13 s 4; L 2008 c 337 s 64; 33 SR 2042*

4715.1010 SIZE OF CLEANOUTS.

The cleanout shall be of the same nominal size as the pipes they serve up to four inches in diameter and not less than four inches for larger piping.

The distance between cleanouts in horizontal piping shall not exceed 50 feet for three inch or less in size and not over 100 feet for four inch and over in size.

Statutory Authority: *MS s 326.37 to 326.45; 326B.43 to 326B.49*

History: *L 2007 c 140 art 6 s 15; art 13 s 4*

4715.1020 CLEANOUT MATERIALS.

The bodies of cleanout ferrules shall be made to standard pipe sizes, conform in thickness to that required for pipes and fittings of the same material and extend not less than one-fourth inch above the hub. The cleanout cover or plug shall be of brass, cast iron, or approved plastic and be provided with a raised nut or recessed socket for removal.

Neoprene or nardel rubber with a plastic disc and a single stainless steel (300 series) band may be used for a cleanout cover provided that it is exposed and readily accessible.

Statutory Authority: *MS s 16B.62; 326.37 to 326.45; 326B.121; 326B.43 to 326B.49*

History: *19 SR 590; L 2007 c 140 art 4 s 61; art 6 s 15; art 13 s 4*

4715.1030 CLEANOUTS TO BE ACCESSIBLE.

Each cleanout, unless installed under an approved cover plate or left flush with the finished floor, shall be at least two inches above grade, readily accessible, and shall not be covered with cement, plaster, or other permanent finish material. Where a soil stack cleanout is located within ten feet of where the building drain leaves the building, the cleanout at the outside wall may be eliminated.

Statutory Authority: *MS s 326.37 to 326.45; 326B.43 to 326B.49*

History: *L 2007 c 140 art 6 s 15; art 13 s 4*

INTERCEPTORS, SEPARATORS, AND BACKWATER VALVES**4715.1100 INTERCEPTORS AND SEPARATORS REQUIRED.**

Interceptors for oil, grease, sand, and other substances harmful or hazardous to the building drainage system shall be provided as stated elsewhere in these rules.

The size, type, and location of each interceptor, and of each separator shall conform to the requirements of this chapter, except that units may be accepted which are engineered and manufactured specifically for the intended function and which are documented by the manufacturer and project design engineer to be properly designed and sized for the specific project, and no waste other than those requiring treatment or separation shall discharge into any interceptor.

Statutory Authority: *MS s 16B.62; 326.37 to 326.45; 326B.121; 326B.43 to 326B.49*

History: *19 SR 590; L 2007 c 140 art 4 s 61; art 6 s 15; art 13 s 4*

4715.1110 GREASE INTERCEPTORS FOR COMMERCIAL BUILDINGS.

A grease interceptor of sufficient size and efficiency shall be installed in the waste line leading from sinks, drains, or other fixtures when, in the opinion of the administrative authority, greasy wastes can be introduced into the drainage system in quantities that can cause line stoppage. Grease interceptors shall be placed as near as possible to the fixture and the grease interceptor shall be vented. No food waste disposer or dishwashing machine shall discharge into the building drainage system through a grease interceptor. Sinks or other fixtures served by grease interceptors shall be trapped and vented ahead of the grease interceptor.

Grease interceptors, when used, shall have a grease retention capacity in pounds of grease, of at least twice the flow-through rate, in gallons per minute.

Grease interceptors shall be equipped with devices to control the rate of water flow through the interceptors so that it does not exceed the rated flow of the interceptor. Air openings on flow control devices must connect to the plumbing vent system.

Statutory Authority: *MS s 16B.62; 326.37 to 326.45; 326B.121; 326B.43 to 326B.49*

History: *19 SR 590; L 2007 c 140 art 4 s 61; art 6 s 15; art 13 s 4*

4715.1115 EXTERIOR GREASE INTERCEPTORS.

Subpart 1. **Authorized uses.** An exterior grease interceptor may be installed if it is acceptable to the administrative authority. Only fixtures that discharge greasy waste may be piped to the interceptor. Dishwashing machines and food waste grinders may not be routed through the interceptor unless the routing is acceptable to the administrative authority.

Subp. 2. **Construction.** The grease interceptor tank must be readily accessible for inspection and maintenance. The tank must comply with parts 5 and 6 of ASTM Standard C1227-98. The name of the tank manufacturer, the liquid holding capacity, and compliance with ASTM C1227-98 for the tank construction must be permanently affixed to the tank.

The grease interceptor must allow a detention time of at least 30 minutes and must be protected from freezing. The landscape must be bermed to divert runoff. The tank must be protected to prevent loadings that may lead to structural collapse.

The materials used in piping to the inlet of the tank must comply with building drain requirements. The tank outlet piping may comply with building sewer materials, unless the outlet piping reenters the building, in which case, the materials must be approved for building drain to point of connection to building sewer.

Baffles or tees must be provided at the inlet and outlet of the tank. The invert of the inlet must be at least two inches above the invert of the outlet. The inlet baffle/tee must extend at least six inches below the liquid level, and the outlet baffle/tee must extend at least 12 inches below the liquid level of the tank. Both inlet and outlet baffles/tees must extend at least six inches above the liquid level. Baffles, tees, and fasteners must be made of plastic or stainless steel.

The tank and baffle design must allow for continuous circulation of air throughout the tank. Vents, if provided, must be at least two inches in diameter, located within the building within ten feet of the interceptor, and must be labeled as the exterior grease interceptor vent. The vent must rise within 45 degrees of the vertical to a point at least six inches above the tank before offsetting horizontally.

Inspection pipes, at least four inches in diameter, must be provided above the baffles/tees. A manhole, at least 24 inches in diameter, must also be provided. The manhole cover must be locked in place, marked with a warning to not enter without proper equipment, and be provided with a label identifying the vessel as the exterior grease interceptor.

The inlet and outlet pipes must be connected to the tank with a sealed flexible joint to accommodate pipe movement. A cleanout, at least four inches in diameter, must be provided on the discharge line from the interceptor.

Subp. 3. **Inspection, testing, and records.** After installation, the tank must pass a manometer test with one inch of water column for five minutes, or a vacuum test with two inches of mercury for 60 minutes. The grease interceptor must be inspected at least once every three months, and must be pumped and cleaned regularly. Records of inspection and maintenance must be kept. The administrative authority shall set the frequency, duration, and availability of the inspections, cleaning, and record-keeping information.

Statutory Authority: *MS s 16B.59; 16B.61; 16B.64; 326.37; 326.40; 326B.101; 326B.106; 326B.13; 326B.43; 326B.46*

History: *28 SR 146; L 2007 c 140 art 4 s 61; art 6 s 15; art 13 s 4*

4715.1120 OIL AND FLAMMABLE LIQUIDS SEPARATOR.

Enclosed garages of over 1,000 square feet or housing more than four motor vehicles, repair garages, gasoline stations with grease racks, work or wash racks, auto washes, and all buildings where oily and/or flammable liquid wastes are produced shall have a separator installed into which all oil, grease, and sand bearing and/or flammable wastes shall be discharged before emptying into the building drainage system or other point of disposal, when floor drains or trench drains are provided. The separator shall be located inside the building.

Exception: Private garages classified as Group U occupancies serving one- and two-family dwellings.

Each separator shall be of watertight construction and of not less than 35 cubic feet holding capacity, be provided with a water seal of not less than three inches on the inlet and not less than 18 inches on the outlet. The minimum depth below the invert of the discharge drain shall be three feet. The minimum size of the discharge drain shall be four inches. The separator may be constructed either: (i) of monolithic poured reinforced concrete with a minimum floor and wall thickness of six inches, (ii) of iron or steel of a minimum thickness of 3/16 inch, protected with an approved corrosion resistant coating on both the inside and the outside, or (iii) of fiberglass resins that comply with ASTM C-581 and meets IAPMO Material and Property Standard, PS 80-2003b, for clarifiers.

The separator must be provided with a nonperforated iron or steel cover and ring of not less than 24 inches in diameter, and the air space in the top of the tank must have a three-inch vent pipe, constructed of approved metallic material, extending separately to a point at least 12 inches above the roof of the building. Drains and piping from motor vehicle areas must be a minimum of three inches in size. Drains discharging to an interceptor must not be trapped and must be constructed so as not to retain liquids. In motor vehicle wash facilities, a sand interceptor which meets the requirements of part 4715.1130, subpart 1, except that no water seal is permitted, may be installed to receive wastes before discharging into a flammable waste separator.

No cleanout, mechanical joint, or backwater valve shall be installed inside the separator which could provide a bypass of the trap seal. Only wastes that require separation shall

discharge into the separator, except that a water supplied and trapped sink may be connected to the vent of the separator. Whenever the outlet branch drain serving a separator is more than 25 feet from a vented drain, such branch drain shall be provided with a two inch vent pipe. A backwater valve shall be installed in the outlet branch drain whenever in the judgment of the administrative authority backflow from the building drain could occur.

A separator must be installed to be readily accessible for service and maintenance, and must be maintained by periodic removal of accumulated liquids and solids from the separator.

Statutory Authority: *MS s 16B.59; 16B.61; 16B.62; 16B.64; 326.37 to 326.45; 326B.101; 326B.106; 326B.121; 326B.13; 326B.43 to 326B.49*

History: *9 SR 1557; 19 SR 590; 28 SR 146; L 2007 c 140 art 4 s 61; art 6 s 15; art 13 s 4; 33 SR 2042*

4715.1130 INTERCEPTORS AND SEPARATORS FOR SPECIFIC INSTALLATIONS.

Subpart 1. **Sand interceptors, commercial establishments.** Sand and similar interceptors for heavy solids shall be so designed and located as to be readily accessible for cleaning, and shall have a water seal of not less than six inches.

Subp. 2. **Laundries.** Commercial laundries shall be equipped with an interceptor having a wire basket or similar device, removable for cleaning, that will prevent passage into the drainage system of solids one-half inch or larger in size, string, rags, button, or other material detrimental to the public sewerage system.

Subp. 3. **Bottling establishments.** Bottling plants shall discharge their process wastes into an interceptor which will provide for separation of broken glass or other solids before discharging liquid wastes into the drainage system.

Subp. 4. **Slaughter houses.** Slaughtering and dressing room drains shall be equipped with separators or interceptors approved by the administrative authority, which shall prevent the discharge into the drainage system of feathers, entrails, or other material likely to clog the drainage system.

Statutory Authority: *MS s 326.37 to 326.45; 326B.43 to 326B.49*

History: *L 2007 c 140 art 6 s 15; art 13 s 4*

4715.1140 VENTING OF INTERCEPTORS AND SEPARATORS.

Interceptors and separators shall be so designed that they will not become airborne if closed covers are used. Each interceptor or separator shall be properly vented.

Statutory Authority: *MS s 326.37 to 326.45; 326B.43 to 326B.49*

History: *L 2007 c 140 art 6 s 15; art 13 s 4*

4715.1150 MAINTENANCE OF INTERCEPTORS AND SEPARATORS.

Interceptors and separators shall be maintained in efficient operating condition by periodic removal of accumulated grease, scum, oil, or other floating substances, and solids, deposited in the interceptor or separator.

Each interceptor and separator shall be so installed that it is readily accessible for removal of cover, servicing, and maintenance. If installed substantially below grade a manhole with flush manhole cover should be provided.

Statutory Authority: *MS s 326.37 to 326.45; 326B.43 to 326B.49*

History: *L 2007 c 140 art 6 s 15; art 13 s 4*

4715.1160 BACKWATER VALVES.

Subpart 1. **Where used.** Drainage piping serving fixtures that are located below the elevation of the curb or property line at the point where the building sewer crosses under

the curb or property line, and above the crown level of the main sewer, shall drain by gravity into the main sewer, and shall be protected from back flow of sewage by installing an approved backwater valve, and each such backwater valve shall be installed only in that branch or section of the drainage system which receives the discharge from fixtures located below the elevation of the curb or property line.

Further, in every building hereafter erected or remodeled so that the erection or remodeling creates a new dwelling use which is located below the elevation of the point where the building sewer crosses under the curb or property line, all fixtures installed below such point shall be connected to a separate branch drain. Each such branch drain shall be protected by an approved backwater valve and a gate valve. The gate valve shall be located on the sewer connection side of the backwater valve.

Further, the backwater valve and gate valve may be waived by the administrative authority whenever the sanitary sewer does not receive any storm water drainage and the building is located at a sufficient height above the public sanitary sewer so flooding by backflow will not occur, in the opinion of the administrative authority.

Subp. 2. **Construction of backwater valves.** Backwater valves shall be constructed so that a mechanical seal against backflow will be provided. Backwater valves shall have all balls or bearing parts of noncorrodible material and shall have bolted covers and be readily accessible for cleaning.

Subp. 3. **Venting of backwater valves.** Where the installation and operation of backwater valves interfere with the proper ventilation of the plumbing system, additional vents shall be provided so as to assure adequate ventilation of the plumbing system when the backwater valves are in a closed position.

Subp. 4. **Accessibility of backwater valves.** Backwater valves shall be installed so their working parts will be readily accessible for service and repairs. If installed substantially below grade a manhole with flush manhole cover shall be provided.

Statutory Authority: *MS s 16B.62; 326.37 to 326.45; 326B.121; 326B.43 to 326B.49*

History: *19 SR 590; L 2007 c 140 art 4 s 61; art 6 s 15; art 13 s 4*

PLUMBING FIXTURES

4715.1200 CONNECTIONS TO PLUMBING SYSTEM REQUIRED.

All plumbing fixtures and drains used to receive or discharge liquid wastes or sewage shall be connected to the drainage system of the building in accordance with the requirements of the code.

Statutory Authority: *MS s 326.37 to 326.45; 326B.43 to 326B.49*

History: *L 2007 c 140 art 6 s 15; art 13 s 4*

4715.1210 REQUIRED MINIMUM NUMBER OF FIXTURES.

For all premises subject to this chapter, plumbing fixtures shall be provided for the type of building occupancy and in the minimum number listed in chapter 1305, Minnesota Building Code.

Statutory Authority: *MS s 16B.59; 16B.61; 16B.62; 16B.64; 326.37 to 326.45; 326B.101; 326B.106; 326B.121; 326B.13; 326B.43 to 326B.49*

History: *19 SR 590; 28 SR 146; L 2007 c 140 art 4 s 61; art 6 s 15; art 13 s 4; 33 SR 2042*

4715.1215 [Repealed, 19 SR 590]

4715.1220 INSTALLATION OF FIXTURES.

Subpart 1. **Fixtures.** Fixtures must be set level and in proper alignment with reference to adjacent walls. No water closet may be set closer than 15 inches from its center to any side wall or partition nor closer than 30 inches, center to center, between toilets. At least a 24-inch clearance must be provided in front of water closets. Note: The centerline of water

closets used primarily by children 12 and younger must be a minimum of 12 inches to a maximum of 18 inches from the side wall or partition (see Minnesota Accessibility Code).

No urinal may be set closer than 15 inches from the center to any side wall or partition, nor closer than 24 inches, center to center, between urinals.

Wall-hung water closet bowls must be rigidly supported by a concealed metal hanger which is attached to the building structural members so that no strain is transmitted to the closet connector or any other part of the plumbing system.

Plumbing fixtures must be so installed as to afford easy access for cleaning both the fixture and the area about it. Where practical, all pipes from fixtures must be run to the nearest wall.

Subp. 2. **Joints.** Joints formed where fixtures come in contact with floors shall be sealed.

Fixtures having concealed slip joint connections shall be provided with an access panel or utility space or other convenient access so arranged as to make the slip joint connections accessible for inspection and repair.

Subp. 3. **Overflows.** In any fixture which is provided with an overflow, the waste shall be designed and installed so that the standing water in the fixture cannot rise in the overflow when the stopper is closed, nor shall any water remain in the overflow when the fixture is empty.

The overflow from any fixture shall discharge into the drainage system on the inlet or fixture side of the trap.

Statutory Authority: *MS s 16B.59; 16B.61; 16B.64; 326.37 to 326.45; 326B.101; 326B.106; 326B.13; 326B.43 to 326B.49*

History: *15 SR 76; 28 SR 146; L 2007 c 140 art 4 s 61; art 6 s 15; art 13 s 4*

4715.1230 AUTOMATIC CLOTHES WASHERS.

A water supply line to an automatic clothes washer shall be protected against backflow by the use of an air gap or vacuum breaker. The discharge shall be through an air break.

Statutory Authority: *MS s 326.37 to 326.45; 326B.43 to 326B.49*

History: *L 2007 c 140 art 6 s 15; art 13 s 4*

4715.1240 BATHTUBS.

Subpart 1. **Outlets.** Bathtubs must have waste outlets and overflows at least one and one-half inches in diameter. The waste control device must be located at the tub outlet.

Subp. 2. **Whirlpool bathtubs.** Whirlpool bathtubs and their installation must comply with ANSI 112.19.7 and ANSI 112.19.8.

Subp. 3. **Drop-in bathtubs.** Bathtubs which do not have a factory applied flange for installation against a wall are considered drop-in-type and must not be installed against a wall.

Statutory Authority: *MS s 16B.61; 16B.62; 326.37 to 326.45; 326B.106; 326B.121; 326B.43 to 326B.49*

History: *15 SR 76; 19 SR 590; L 2007 c 140 art 4 s 61; art 6 s 15; art 13 s 4*

4715.1250 DISHWASHING EQUIPMENT.

Every dishwasher in a building for public use shall discharge to the drainage system through an air break or an air gap, except: (1) a domestic-type dishwasher installed under the counter in an employee break room or in any location other than a food establishment, may discharge into the sink tailpiece or food waste grinder if the discharge drain line is fastened as high as possible under the countertop; and (2) the dishwasher may be connected directly to the drainage system if a floor drain constructed without a backwater valve is installed on the individual dishwasher branch. The water supply to any dishwasher in which

4715.1250 PLUMBING CODE

868

the supply opening is located below the spill line of the machine shall be protected with a vacuum breaker.

Statutory Authority: *MS s 16B.59; 16B.61; 16B.64; 326.37; 326.40; 326B.101; 326B.106; 326B.13; 326B.43; 326B.435; 326B.46*

History: *28 SR 146; L 2007 c 140 art 4 s 61; art 6 s 15; art 13 s 4; 33 SR 2042*

4715.1260 DRINKING FOUNTAINS.

Drinking fountains must be constructed of impervious nonoxidizing material and must be so designed that they may be easily cleaned. The water should be carried to the fixture in an independent pipe, and no part of the fixture must be used in conveying water to the jet. The design of the fixture must be such that no part of the supply pipe can be submerged in the fixture, or in the waste pipe from the fixture. The jet must be slanting and the orifice of the jet must be protected in such a manner that it cannot be contaminated by droppings from the mouth or by splashing from the basin. The orifice of the jet must be at least one inch above the rim of the basin. All fountains should be so designed that their proper use is self-evident.

Installation of a combined cold water faucet and drinking fountain bubbler is prohibited for public use. If a drinking fountain bubbler is provided at a public use sink, it must have at least an 18-inch separation from any other faucet spout.

Statutory Authority: *MS s 16B.61; 16B.62; 326.37 to 326.45; 326B.106; 326B.121; 326B.43 to 326B.49*

History: *15 SR 76; 19 SR 590; L 2007 c 140 art 4 s 61; art 6 s 15; art 13 s 4*

4715.1300 FLOOR DRAINS.

Subpart 1. **Floor drain trap and strainer.** A floor drain shall be considered a plumbing fixture and shall be provided with a trap seal and a removable strainer. The open area of the strainer shall be at least equal to the cross-section area of the drain line to which it connects.

Subp. 2. **Basement floor drains.** Basement floor drains or floor drains installed in floors which are laid directly on the ground shall be provided with either an integral trap constructed with a spigot outlet or a "P" trap of cast iron or other approved materials compatible with the drainage pipe with a spigot outlet and provisions for a caulked connection to the drain body. A vacuum breaker shall be installed on the water supply to flush rim floor drains.

Subp. 3. **Provision for evaporation.** Where floor drains are subject to evaporation, they shall be of the deep seal type, with a minimum water seal of three inches and may be provided with a water supply through an air gap, from a plumbing fixture, automatic priming device, or other approved means, to maintain the minimum water seal.

Subp. 4. **Venting of floor drains.** Floor drain fixture branches that are less than 25 feet in length and connect to a vented main or branch do not require an individual vent. The following shall be vented in accordance with parts 4715.2520, subparts 5 and 6; 4715.2550, subpart 3; and 4715.2620, subpart 4: floor drains receiving liquid waste flows that could siphon the trap seal; trench drains and floor sinks used as a receptor; and floor drains used for shower drains, recessed slop, or similar receptors.

Subp. 5. [Repealed, 19 SR 590]

Subp. 6. **Garage and parking area floor drains.** Floor area drains in open parking areas, including open areas of parking ramps, must discharge to the storm sewer if available. Floor drains in parking areas which are enclosed, and floor drains in areas open or enclosed which are used for maintenance or as a vehicle wash bay, must discharge to the sanitary sewer if a municipal sewer is available. Oil and flammable liquid separators must be provided if required by part 4715.1120.

Exception: Floor drains in private garages classified as Group U, Division 1 occupancies serving one- and two-family dwellings may discharge to daylight if approved by the administrative authority.

Statutory Authority: *MS s 16B.59 to 16B.75; 326.37 to 326.45; 326B.101 to 326B.194; 326B.43 to 326B.49*

History: *15 SR 76; 19 SR 590; 23 SR 686; L 2007 c 140 art 4 s 61; art 6 s 15; art 13 s 4; L 2008 c 337 s 64; 33 SR 2042*

4715.1305 ELEVATOR PIT DRAIN.

An elevator pit drain must discharge to the sanitary sewer using an indirect connection that precludes the possibility of sewage backup into the pit. If a sump is used, it must be outside the pit with a dry pan drain flowing to it.

Statutory Authority: *MS s 16B.61; 326B.106*

History: *15 SR 76; L 2007 c 140 art 4 s 61; art 13 s 4*

4715.1310 FOOD-WASTE GRINDER UNITS.

Domestic food-waste grinders shall be connected to a drain of not less than 1-1/2 inches in diameter.

Commercial food-waste grinders shall be connected to a drain of sufficient size to serve the unit, but in no case connected to a drain of less than two inches in diameter, and shall be connected, trapped, and vented separately from any other fixtures or compartments.

All food-waste grinders shall be provided with an adequate supply of water in sufficient flow rate to insure proper functioning of the unit. The water supply line to a commercial food waste grinder, which is equipped with a water rinsed funnel, shall be protected against back-siphonage by an air gap or vacuum breaker.

No food-waste grinders shall be connected so as to discharge through a grease interceptor.

Statutory Authority: *MS s 326.37 to 326.45; 326B.43 to 326B.49*

History: *L 2007 c 140 art 6 s 15; art 13 s 4*

4715.1320 FLUSHING DEVICES FOR WATER CLOSETS AND URINALS.

Each water closet, urinal, clinical sink, or similar fixture shall be provided with a flushometer valve, flush tank, or similar device designed and installed so as to supply water in sufficient quantity and rate of flow to flush to the sewer the contents of the fixture to which it is connected to cleanse the fixture and refill the fixture trap.

A flushing device shall serve only one fixture with the exception that a single flush tank may be used to flush more than one urinal provided that the flushing cycle is controlled automatically and that each urinal or section thereof is thoroughly flushed. Automatically controlled flushometer valves may be substituted for flush tanks.

Statutory Authority: *MS s 326.37 to 326.45; 326B.43 to 326B.49*

History: *L 2007 c 140 art 6 s 15; art 13 s 4*

4715.1330 FLUSH TANKS.

Subpart 1. **Water supply for flush tanks.** An adequate quantity of water shall be provided to flush and clean the fixture served. The fixture supply to a flush tank must have a shutoff valve. The water supply to flush tanks equipped for manual flushing shall be controlled by a float valve or other automatic device designed to refill the tank after each discharge and to completely shut off the water flow to the tank when the tank is filled to operational capacity. Provision shall be made to automatically supply water to the fixture so as to refill the trap seal after each flushing, the water supply to flush tanks equipped for automatic flushing shall be controlled by a suitable timing device. (See part 4715.1770, subpart 2.)

4715.1330 PLUMBING CODE

870

Subp. 2. **Overflows in flush tanks.** Flush tanks shall be provided with overflows discharging to the water closet or urinal connected thereto and of sufficient size to prevent flooding of the tank at the maximum rate of water supply. Where the float valve is below the rim of the flush tank, it shall be elevated above the overflow and provided with a vacuum breaker or air gap. (See part 4715.2150, subpart 2, protective devices.)

Statutory Authority: *MS s 16B.62; 326.37 to 326.45; 326B.121; 326B.43 to 326B.49*

History: *19 SR 590; L 2007 c 140 art 4 s 61; art 6 s 15; art 13 s 4*

4715.1340 FLUSHOMETER VALVES.

Flushometers shall be installed so that they will be readily accessible for repair. Flushometer valves shall not be used where the water pressure is insufficient to properly operate them. (See part 4715.1770, subpart 2.) When the valve is operated, it shall complete the cycle of operation automatically, opening fully and closing positively under the water line pressure. Each flushometer shall be provided with a means for regulating the flow through it. Flushometer valves installed on any plumbing fixture or equipment whose water supply inlet or portion thereof can be submerged shall be provided with a vacuum breaker.

Statutory Authority: *MS s 326.37 to 326.45; 326B.43 to 326B.49*

History: *L 2007 c 140 art 6 s 15; art 13 s 4*

4715.1350 GARBAGE CAN WASHERS.

Garbage can washers shall be separately trapped and vented. The receptacle receiving the wash from the garbage cans shall be provided with a removable basket or strainer to prevent discharge of large particles into the building drainage system. Any water supply connection shall be protected against backflow by an air gap or a vacuum breaker.

Statutory Authority: *MS s 326.37 to 326.45; 326B.43 to 326B.49*

History: *L 2007 c 140 art 6 s 15; art 13 s 4*

4715.1360 LAUNDRY TRAYS.

Each compartment of a laundry tray shall be provided with a waste outlet not less than 1-1/2 inches in diameter. A strainer or crossbar shall be provided to restrict the clear opening of the waste outlet. The water supply faucet shall have a plain end spout or, if threaded, shall be equipped with a vacuum breaker.

Statutory Authority: *MS s 326.37 to 326.45; 326B.43 to 326B.49*

History: *L 2007 c 140 art 6 s 15; art 13 s 4*

4715.1370 LAVATORIES.

Lavatories shall have waste outlets not less than 1-1/4 inches in diameter. A strainer, pop-up stopper, crossbars, or similar device shall be provided.

Water supply to public lavatories shall not be spring closing unless they are of the delayed action type.

Each 18-inch unit of usable length of a straight-line or circumference of a circular multiple use lavatory shall be considered equivalent to one lavatory as it affects the fixture usage requirements; provided hot and cold or tempered water suitable for hand washing is available for each 18-inch interval.

Statutory Authority: *MS s 326.37 to 326.45; 326B.43 to 326B.49*

History: *L 2007 c 140 art 6 s 15; art 13 s 4*

4715.1380 SHOWERS.

Subpart 1. **Water supply riser.** Every water supply riser from the shower valve to the shower head outlet, whether exposed or not, shall be securely attached to the structure.

Subp. 2. **Shower waste outlet.** Waste outlets, other than those in bathtubs, serving a single shower shall be at least 1-1/2 inches in diameter and have removable strainers not

less than three inches in diameter having strainer openings not less than one-fourth inch in minimum dimension. Waste outlets shall be securely fastened to the waste pipe making a watertight connection thereto. Waste outlets serving showers, except single-head showers, must be at least two inches in diameter and must have removable strainers not less than three inches in diameter. Where each shower space is not provided with an individual waste outlet, the waste outlet must be located and the floor pitched so that the water from one shower does not flow over the floor area serving another shower. The floor and waste outlet design must not require a shower user to stand in or walk across the wastewater flowing from another shower space.

Subp. 3. **Shower floors or receptors.** Floors or receptors under shower compartments shall be laid on or be supported by a smooth and structurally sound base. Floors under shower compartments, other than those laid directly on the ground surface or where prefabricated receptors have been provided, shall be lined and made watertight by the provision of suitable shower pans of durable material. Such pans shall turn up on all sides at least two inches above the finished threshold level. Pans shall be securely fastened to the waste outlet at the seepage entrance making a watertight joint between the pan and the outlet. Finished floor surfaces shall be constructed of smooth, noncorrosive, nonabsorbent, and waterproofed materials.

Subp. 4. **Shower compartments.** No shower stall or receptor shall have a finished interior dimension which is less than 30 inches, and each shower compartment shall be of a finished size capable of completely encompassing a 30-inch circle measured at the height of the shower control handles, when the door or curtain is closed, and of a horizontal cross sectional area of not less than 900 square inches. The 30-inch requirement shall not apply to a bathtub used as a shower or to showers installed in remodeling.

Subp. 5. **Anti-scald devices.** A shower or combination shower-bath in a new or remodeled installation must be equipped with an anti-scald type shower control valve. The valve must be of the thermostatic or pressure-balancing type in accordance with ANSI/ASSE Standard 1016-96.

The temperature of mixed water to multiple showers must be controlled by a master anti-scald type thermostatic blender, or the showers must be individually equipped with approved anti-scald type shower control valves.

Statutory Authority: *MS s 16B.59; 16B.61; 16B.62; 16B.64; 326.37 to 326.45; 326B.101; 326B.106; 326B.121; 326B.13; 326B.43 to 326B.49*

History: *15 SR 76; 19 SR 590; 28 SR 146; L 2007 c 140 art 4 s 61; art 6 s 15; art 13 s 4; 33 SR 2042*

4715.1390 SINKS.

Subpart 1. **Drain sizing.** Sinks shall be provided with waste outlets not less than 1-1/2 inches in diameter. A strainer, crossbar, or similar device shall be provided. Sinks on which a food grinder is installed shall have a waste opening of not less than 3-1/2 inches in diameter. Pot or scullery sinks must be provided with waste outlets not less than two inches in diameter.

Subp. 2. **Commercial kitchen sinks.** All pot, scullery, food preparation, and bar sinks must be connected directly to the drainage system. A floor drain constructed without a back-water valve must be installed on the individual branch serving the fixture to be protected.

Subp. 3. **Adjustable sink systems.** Adjustable tailpiece sink systems must comply with ASME Standard A 112.19.12-2006 Wall Mounted, Pedestal Mounted, Adjustable, Elevating, Tilting, and Pivoting Lavatory, Sink, and Shampoo Bowl Carrier Systems and Drain Waste Systems. The tailpiece must be of rigid construction.

Statutory Authority: *MS s 16B.59 to 16B.75; 326.37 to 326.45; 326B.101 to 326B.194; 326B.43 to 326B.49*

History: *23 SR 686; 28 SR 146; L 2007 c 140 art 4 s 61; art 6 s 15; art 13 s 4; L 2008 c 337 s 64; 33 SR 2042*

4715.1400 PLUMBING CODE

872

4715.1400 SPECIAL PLUMBING FIXTURES.

Baptisteries, ornamental and lily pools, aquariums, ornamental fountain basins, swimming pools, and similar constructions when provided with water supplies shall be protected from back-siphonage as required in parts 4715.2000 to 4715.2170.

Statutory Authority: *MS s 326.37 to 326.45; 326B.43 to 326B.49*

History: *L 2007 c 140 art 6 s 15; art 13 s 4*

4715.1410 URINALS.

Floor-type trough urinals are prohibited.

Statutory Authority: *MS s 14.389; 326.37 to 326.45; 326B.43 to 326B.49*

History: *L 2007 c 140 art 6 s 15; art 13 s 4; 35 SR 1171*

NOTE: This part was amended effective July 5, 2011. When effective, this part will read:
"4715.1410 URINALS.

Subpart 1. **Prohibited urinals.** Floor-type trough urinals are prohibited.

Subp. 2. **Nonwater urinals.** Nonwater urinals must comply with ASME A112.19.19-2006. Where a nonwater urinal is installed, a water-supplied fixture must be installed upstream of the nonwater urinal at the end of the same drainage branch. The water distribution system must be designed to allow for replacement of nonwater urinals with water-supplied urinals without dead ends.

Each nonwater urinal must be separately trapped by a nonpetroleum liquid seal that is lighter than water to protect from odor escape or evaporation of the trap contents. Metallic traps or traps with elastomeric membranes for nonwater urinals are prohibited.

Nonwater urinals that meet the requirements of this part are exempt from fixture trap requirements described in parts 4715.0900 and 4715.0960.

The owner of each nonwater urinal must ensure that the urinal is cleaned and maintained in strict compliance with the manufacturer's requirements."

Statutory Authority: *MS s 14.389*

History: *35 SR 1171*

4715.1420 WATER CLOSETS.

Subpart 1. **Prohibited water closets.** Pan, valve, plunger, offset, latrine, and frost-proof water closets are prohibited. Water closets which have an invisible seal, an unventilated space, or walls that are not thoroughly washed at each discharge, are prohibited. Any water closet which might permit siphonage of the contents of the bowl back into the flush tank is prohibited.

Subp. 2. **Water closet bowls.** All water closet bowls must be of the elongated type, except that regular type round bowls may be used in residential or dwelling type occupancy.

Subp. 3. **Water closet seats.** Water closets must be equipped with seats of smooth nonabsorbent material. All seats of water closets of elongated type provided for public use must be of the open-front type. Integral water closet seats must be of the same material as the fixture. The top of the seat must not be over two inches above the rim of the fixture; seat lifts may not be used.

Statutory Authority: *MS s 16B.59 to 16B.73; 326.37 to 326.45; 326B.101 to 326B.151; 326B.43 to 326B.49*

History: *11 SR 1405; L 2007 c 140 art 4 s 61; art 6 s 15; art 13 s 4; L 2008 c 337 s 64*

HANGERS AND SUPPORTS AND PROTECTION

4715.1430 HANGERS AND SUPPORTS.

Subpart 1. **Material.** Hangers, anchors, and supports shall be made of metal or other material of sufficient strength to support the piping and its contents. Piers may be concrete, brick, or other approved material.

Subp. 2. **Attachment to building.** Hangers and anchors shall be securely attached to the building construction at sufficiently close intervals to support the piping and its contents.

Subp. 3. **Vertical piping.** Vertical piping shall be secured at sufficiently close intervals to keep the pipe in alignment. Vertical piping of the following materials shall be supported at not more than the distance intervals shown:

- A. Cast-iron soil pipe, at base and at each story height. Neoprene jointed pipe at five foot intervals, except where ten foot lengths are used.
- B. Threaded pipe (SPS), every other story height.
- C. Copper tubing, at each story.
- D. Lead pipe, four foot intervals.
- E. Plastic pipe, 1-1/4 inch and 1-1/2 inch sizes, exposed pipe at four foot intervals, concealed pipe same as item F (two inches and over).
- F. Plastic pipe, two inch and over, at each story.

Subp. 4. **Horizontal piping.** Horizontal piping shall be supported at sufficiently close intervals to keep it in alignment and prevent sagging:

- A. Cast-iron soil pipe, five foot intervals except where ten foot lengths of cast-iron soil pipe are used, ten foot intervals between supports are acceptable.
- B. Threaded pipe, 12 foot intervals.
- C. Copper tubing (1-1/4 inch or less), six foot intervals.
- D. Copper tubing (1-1/2 inch or over), ten foot intervals.
- E. Lead pipe, on continuous metal or wood strips for its entire length.
- F. Plastic pipe, 32-inch intervals except where conveying waste from dishwashers or similar hot water wastes it shall be supported on continuous metal or wood strips for its entire length.

Subp. 5. **Closet bends.** Joined to a stack by means of neoprene gasketed or solvent welded joints shall be adequately supported both vertically and horizontally to prevent movement in any direction.

Subp. 6. **Base of stacks.** Stacks shall be adequately supported at their bases.

Subp. 7. **Piping in the ground.** Piping in the ground shall be laid on a firm bed for its entire length, except where support is otherwise provided which is adequate in the judgment of the administrative authority. Installation of plastic sewer pipe must comply with ASTM D2321.

Statutory Authority: *MS s 16B.59 to 16B.75; 326.37 to 326.45; 326B.101 to 326B.194; 326B.43 to 326B.49*

History: *23 SR 686; L 2007 c 140 art 4 s 61; art 6 s 15; art 13 s 4; L 2008 c 337 s 64*

4715.1440 PROTECTION OF PLASTIC PIPE.

All plastic and copper pipe and tubing passing through studs or plates that are within one and one-fourth inches of the outside of the stud or plate must be protected by the provision of 1/16 inch or 0.060 mild steel plates attached to the outside of the stud or plate, or equivalent protection.

Statutory Authority: *MS s 16B.61; 16B.62; 326.37; 326B.106; 326B.121; 326B.43*

History: *15 SR 76; 19 SR 590; L 2007 c 140 art 4 s 61; art 6 s 15; art 13 s 4*

INDIRECT WASTE PIPING

4715.1500 INDIRECT WASTE CONNECTIONS.

No cold storage room, refrigerator, cooling counter, compartment, receptacle, appurtenance, or device, which is used, designed, or intended to be used for the storage or holding of food or drink, shall have any drain pipe in connection therewith directly connected to any soil, waste, or vent pipe. Such equipment shall be discharged to the drainage system through an airbreak as defined in part 4715.1580.

4715.1500 PLUMBING CODE

874

The foregoing does not apply to a dishwashing or culinary sink in a food preparation room.

Statutory Authority: *MS s 326.37 to 326.45; 326B.43 to 326B.49*

History: *L 2007 c 140 art 6 s 15; art 13 s 4*

4715.1510 INDIRECT WASTE PIPING.

Indirect waste piping must be installed so as to permit ready access for flushing and cleaning, and must meet the material requirements of the code. Except as otherwise herein provided, the size and construction of indirect waste piping must be in accordance with parts 4715.2300 to 4715.2660, regulating the installation of waste and vent piping.

Indirect waste pipes from appliances, devices, or other equipment not regularly classed as plumbing fixtures, but which are equipped with drainage outlets, must be trapped, but the traps need not be vented and the waste pipe must be a minimum of three-fourths inch size, but not less than the size of the outlet or tail piece of the fixture, appliance, or equipment served. However, overflow pans and drip outlets need not be trapped and may be the same size as the outlet. Alternate materials may be accepted for drains from overflow pans and drip outlets if proper pitch, alignment, and support are maintained.

Statutory Authority: *MS s 16B.59 to 16B.73; 326.37 to 326.45; 326B.101 to 326B.151; 326B.43 to 326B.49*

History: *11 SR 1405; 19 SR 590; L 2007 c 140 art 4 s 61; art 6 s 15; art 13 s 4; L 2008 c 337 s 64*

4715.1520 CONNECTIONS FROM WATER DISTRIBUTION SYSTEM.

Indirect waste connections shall be provided for drains, overflows, or relief vents from the water distribution system by means of an air gap.

Statutory Authority: *MS s 326.37 to 326.45; 326B.43 to 326B.49*

History: *L 2007 c 140 art 6 s 15; art 13 s 4*

4715.1530 STERILIZERS.

Appliances, devices, equipment, or other apparatus such as stills, sterilizers, and similar equipment requiring water and waste shall be indirectly connected, or provided with an air gap between the trap and the appliance.

Statutory Authority: *MS s 326.37 to 326.45; 326B.43 to 326B.49*

History: *L 2007 c 140 art 6 s 15; art 13 s 4*

4715.1540 POTABLE CLEAR WATER WASTES.

Expansion tanks, cooling jackets, sprinkler systems, or any similar devices which are directly connected to the potable water system and which waste clear water only shall be discharged to the drainage system through an air gap.

Statutory Authority: *MS s 326.37 to 326.45; 326B.43 to 326B.49*

History: *L 2007 c 140 art 6 s 15; art 13 s 4*

4715.1550 DRINKING FOUNTAINS.

Drinking fountains may be installed with indirect wastes.

Statutory Authority: *MS s 326.37 to 326.45; 326B.43 to 326B.49*

History: *L 2007 c 140 art 6 s 15; art 13 s 4*

4715.1560 SWIMMING POOLS.

Piping carrying waste water from swimming pools or wading pools, including pool drainage, backwash from filters, water from scum gutter drains, or floor drains which serve

walks around pools, shall be installed as an indirect waste. Pumps may be utilized to lift waste water when the indirect waste line is below the sewer grade.

Statutory Authority: *MS s 326.37 to 326.45; 326B.43 to 326B.49*

History: *L 2007 c 140 art 6 s 15; art 13 s 4*

4715.1570 METHOD OF PROVIDING AN AIR GAP.

The air gap between the indirect waste pipe and the building drainage system must be at least twice the effective diameter of the drain served and must be provided by one of the following methods:

A. To a receptor. Extend an indirect waste pipe to an open, accessible, individual waste sink, floor drain, or other suitable fixture which is properly trapped and vented.

The indirect waste pipe must terminate a sufficient distance above the flood level rim of the receiving fixture to provide the required air gap.

B. To the inlet side of a trap. Provide an air gap in the drain ahead of the connection to the inlet side of the trap, which receives the waste from the indirect waste.

Statutory Authority: *MS s 16B.59 to 16B.73; 326.37 to 326.45; 326B.101 to 326B.151; 326B.43 to 326B.49*

History: *11 SR 1405; L 2007 c 140 art 4 s 61; art 6 s 15; art 13 s 4; L 2008 c 337 s 64*

4715.1580 METHOD OF PROVIDING AN AIR BREAK.

The air break shall be so installed as to prevent back flow into the fixture, appliance, or device by one of the following methods:

A. Discharging to the inlet side of the trap of a floor drain, sink, or receptor whose flood level rim is below the bottom of the fixture to be protected.

B. Discharging at or below the spill rim of a floor drain, sink, or receptor whose flood level rim is below the bottom of the fixture to be protected.

Statutory Authority: *MS s 326.37 to 326.45; 326B.43 to 326B.49*

History: *L 2007 c 140 art 6 s 15; art 13 s 4*

4715.1590 RECEPTORS OR SUMPS.

Subpart 1. **Installment.** Waste receptors or sumps receiving the indirect waste shall not be installed in any toilet room, nor in inaccessible or unventilated space, such as a closet or storeroom.

Subp. 2. **Design.** All plumbing receptors receiving the discharge of indirect waste pipes shall be of such shape and capacity to prevent splashing or flooding.

Subp. 3. **Domestic or culinary fixtures prohibited as receptors.** No plumbing fixture which is used for domestic or culinary purposes shall be used to receive the discharge of an indirect waste. Domestic use dishwashers may discharge into a sink, or discharge to a sink tailpiece or food-waste grinder if the discharge drain line is fastened as high as possible under the countertop.

Subp. 4. **Stand pipe receptors.** The stand pipe receptor for an automatic clothes washer shall be trapped and vented, except that multiple clothes washers in the same room may be discharged to multiple standpipes that are manifolded together and use a single trap. The stand pipe shall extend not more than 30 inches, nor less than 18 inches above its trap, and the trap shall be installed at least six inches above the floor.

Subp. 5. [Repealed, 19 SR 590]

Statutory Authority: *MS s 16B.61; 16B.62; 326.37 to 326.45; 326B.106; 326B.121; 326B.43 to 326B.49*

History: *15 SR 76; 19 SR 590; L 2007 c 140 art 4 s 61; art 6 s 15; art 13 s 4; 33 SR 2042*

SPECIAL WASTES

4715.1600 CHEMICAL WASTES.

Chemical or industrial liquid wastes which are likely to damage or increase maintenance costs on the drainage system, shall be pretreated to render them innocuous prior to discharge into the drainage system, when required by the administrative authority.

Piping conveying industrial, chemical, or process wastes from their point of origin to sewer connected pretreatment facilities shall be of such material and design as to adequately perform its intended function to the satisfaction of the administrative authority. Drainage discharge piping from pretreatment facilities or interceptors shall conform to standard drainage installation procedure.

No chemical vent shall intersect or tie into any vent for other services, except where permitted by the administrative authority.

The provision of this part relative to materials and construction for chemical piping need not apply to domestic photographic darkroom installations.

Statutory Authority: *MS s 326.37 to 326.45; 326B.43 to 326B.49*

History: *L 2007 c 140 art 6 s 15; art 13 s 4*

4715.1610 STEAM AND HOT WATER WASTES.

The end of the blowoff piping from any boiler or the vent pipe from any blowoff tank shall not terminate in any location where the discharge can endanger the safety of any person or property.

The exhaust, blowoff, or drain from a boiler or heat exchanger shall not connect directly with any part of the drainage system, but may connect indirectly.

All such pipes from a high pressure steam source shall be indirectly connected by discharging into a blowoff tank or condenser as required by the state of Minnesota high pressure steam code.

All such pipes from low-pressure steam boilers and hot water boilers rated at 150 horsepower or more shall discharge into a tank or condenser such that the discharge shall be effectively lowered below 180 degrees Fahrenheit and the pressure reduced to atmospheric.

In a similar manner, all other such pipes which would cause a discharge of steam or water to enter the sewer above 180 degrees Fahrenheit for a period of more than ten minutes shall be equipped with a means of lowering the entering temperature below 180 degrees Fahrenheit. This provision is not meant to be applied to boilers or heat exchangers which are drained on rare occasions. Drains from pressing machines and similar equipment may waste into an open floor drain.

Any closed condenser or sump shall be provided with a relief vent not less than one pipe size larger than the largest inlet, which relief pipe or vent should be taken off the top, and extended separately full size through the roof.

Statutory Authority: *MS s 326.37 to 326.45; 326B.43 to 326B.49*

History: *L 2007 c 140 art 6 s 15; art 13 s 4*

WATER SUPPLY AND DISTRIBUTION

4715.1700 WATER REQUIRED.

Every building equipped with plumbing fixtures and used for human occupancy or habitation shall be provided with a supply of potable water, which meets the standards of the Department of Health, in the amounts and at the pressures specified in this chapter. For permanent residences or buildings in which people are employed, hot water shall be provided to all plumbing fixtures requiring hot water for proper use.

Only potable water shall be accessible to plumbing fixtures supplying water for drinking, bathing, culinary use, or the processing of food, medical, or pharmaceutical products. Only potable water shall be supplied to emergency showers and eyewashes.

Statutory Authority: *MS s 326.37 to 326.45; 326B.43 to 326B.49*

History: *L 2007 c 140 art 6 s 15; art 13 s 4; 33 SR 2042*

4715.1710 WATER SERVICE.

Subpart 1. **Size of water service.** The water service pipe shall be of sufficient size to furnish water to the building in quantities and at the pressures required elsewhere in the code. It shall in no case be less than three-fourths inch nominal diameter. Methods for sizing the water service pipe are described in parts 4715.3500 to 4715.3800.

Subp. 2. **Separation of water service and building sewer.** Except as permitted in this subpart, the underground water service pipe and the building drain or building sewer shall not be less than ten feet apart horizontally and shall be separated by undisturbed or compacted earth.

NOTE: See chapter 4725 relating to wells and borings regarding separation of buried sewers from wells.

The water service pipe may be placed in the same trench with the building drain and the building sewer provided approval is given by the administrative authority and the following conditions are met:

A. The bottom of the water service pipe, at all points, shall be at least 12 inches above the top of the sewer line at its highest point.

B. The water service pipe shall be placed on a solid shelf excavated at one side of the common trench. The water service pipe shall preferably be of one piece. Where this is not feasible the number of joints in the service pipe shall be kept to a minimum.

C. The sewer and water service pipes shall be tested prior to backfilling, as described in part 4715.2820, or by methods acceptable to the administrative authority.

D. Where the provisions of items A and B cannot be met, the sewer pipe shall be of cast iron or plastic 6A, 6B, 6C(2), or 6C(3) and the water pipe of copper, ductile or cast iron, or plastic 6D, 6E, 6F, 6G, or 6I (part 4715.0420, subpart 3).

E. Where the water service pipe must cross the building sewer, the bottom of the water service pipe located within ten feet of the point of crossing shall be at least 12 inches above the top of the sewer, except where this is not feasible, the sewer shall be of cast iron or plastic 6A, 6B, 6C(2), 6C(3), or 6C(4) (part 4715.0420, subpart 3) for at least ten feet on either side of the crossing.

Subp. 3. **Water service near sources of pollution.** Potable water service pipes must not be located in, under, or above cesspools, septic tanks, septic tank drainage fields, seepage pits, soil treatment systems, sewer manholes, catch basins, buried tanks containing chemicals or petroleum products, or any other source of pollution that in the judgment of the administrative authority might contaminate the potable water supply. A horizontal separation of ten feet must be maintained between the outer edge of the water service pipe and the outer edge of the contamination source.

Statutory Authority: *MS s 16B.62; 326.37 to 326.45; 326B.121; 326B.43 to 326B.49*

History: *9 SR 1557; 19 SR 590; L 2007 c 140 art 4 s 61; art 6 s 15; art 13 s 4; 33 SR 2042*

4715.1720 DESIGN OF BUILDING WATER DISTRIBUTION SYSTEM.

The design of the building hot and cold water distribution system shall conform to good engineering practice. Methods used to determine pipe sizes shall be acceptable to the

administrative authority. (A guide to the design of building water supply systems is given in parts 4715.3500 to 4715.3800.)

Statutory Authority: *MS s 326.37 to 326.45; 326B.43 to 326B.49*

History: *L 2007 c 140 art 6 s 15; art 13 s 4*

4715.1730 SIZE OF FIXTURE BRANCH.

Subpart 1. **Requirement.** The minimum size of the fixture branch pipe shall be as shown in subpart 2. The branch pipe to any fixture shall terminate not more than 30 inches from the point of connection to the fixture and in every instance shall be brought to the floor or wall adjacent to the fixture. No concealed water branch pipe shall be less than one-half inch in size. In single-family dwelling units, not more than three fixtures located in the same room may be supplied by a one-half inch size pipe.

Subp. 2. **Table of minimum sizes of fixture water branch lines.**

Type of fixture or device	Nominal pipe size (inches)
Bath tubs	1/2
Combination sink and tray	1/2
Cuspidor	1/2
Drinking fountain	1/2
Dishwasher (domestic)	1/2
Kitchen sink (res.)	1/2
Kitchen sink (com.)	3/4
Lavatory	1/2
Laundry tray	1/2
Sinks (service, slop)	1/2
Sinks flushing rim	3/4
Urinal (flush tank)	1/2
Urinal (direct flush valve)	3/4
Water closet (tank type)	1/2
Water closet (flush valve type)	1
Hose bibbs	3/4
Wall hydrant	3/4
Domestic clothes washer	1/2
Shower (single head)	1/2

Statutory Authority: *MS s 326.37 to 326.45; 326B.43 to 326B.49*

History: *L 2007 c 140 art 6 s 15; art 13 s 4; 33 SR 2042*

4715.1740 WATER PRESSURE.

When street main pressure exceeds 80 psi, an approved pressure reducing valve shall be installed in the water service pipe near its entrance to the building to reduce water pressure to 80 psi or lower. Where street water main pressures fluctuate significantly, the building water distribution system shall be so designed for the minimum pressure available.

Whenever water pressure from the street main or other source of supply is insufficient to provide flow pressure at fixture outlets as required under part 4715.1770, a booster pump and pressure tank or other approved means shall be installed on the building water supply system. See part 4715.1810 for installation.

Statutory Authority: *MS s 326.37 to 326.45; 326B.43 to 326B.49*

History: *L 2007 c 140 art 6 s 15; art 13 s 4; 33 SR 2042*

4715.1750 WATER HAMMER.

In all building supply systems in which devices or appurtenances are installed which cause noises due to water hammer, protective devices or approved mechanical shock absorbers shall be installed as close as possible to the quick-acting valve causing the water hammer. Where mechanical devices are used the manufacturer's specifications shall be followed as to location and method of installation.

Statutory Authority: *MS s 16B.59 to 16B.75; 326.37 to 326.45; 326B.101 to 326B.194; 326B.43 to 326B.49*

History: *23 SR 686; L 2007 c 140 art 4 s 61; art 6 s 15; art 13 s 4; L 2008 c 337 s 64*

4715.1760 SUPPLY DEMAND.

The supply demand in gallons per minute in the building water distribution system shall be determined on the basis of the load in terms of supply fixture units and of the relationship between load and supply demand.

Statutory Authority: *MS s 326.37 to 326.45; 326B.43 to 326B.49*

History: *L 2007 c 140 art 6 s 15; art 13 s 4*

4715.1770 MINIMUM PRESSURES REQUIRED IN WATER DISTRIBUTION SYSTEM.

Subpart 1. **Requirement.** Based on the minimum static water pressure available, pipe sizes shall be selected so that under conditions of peak demand a minimum flow pressure at the point of discharge shall not be less than shown in subpart 2.

In determining minimum pressures at the outlets, allowance shall be made for the pressure drop due to friction loss.

Subp. 2. **Table of minimum flow pressure and flow rates.**

Location	Flow Pressure psi	Flow Rate gpm
Ordinary basin faucet	8	2.0
Self-closing basin faucet	8	2.0
Sink faucet, 3/8 inch	8	2.0
Sink faucet, 1/2 inch	8	2.0
Bath tub faucet	8	6.0
Laundry tub cock, 1/2 inch	8	5.0
Shower	8	2.0
Ball cock for closet	8	3.0
Flush valve for closet	15	15-35
Flushometer valve for urinal	15	15.0
Drinking fountains	15	0.75
Sill cock-wall hydrant	10	5.0

Statutory Authority: *MS s 16B.59 to 16B.75; 326.37 to 326.45; 326B.101 to 326B.194; 326B.43 to 326B.49*

History: *23 SR 686; 28 SR 146; L 2007 c 140 art 4 s 61; art 6 s 15; art 13 s 4; L 2008 c 337 s 64*

INSTALLING THE BUILDING WATER DISTRIBUTION SYSTEM

4715.1800 WATER SUPPLY CONTROL VALVES.

Subpart 1. **Stop and waste valves prohibited.** Combination stop and waste valves or cocks shall not be installed underground in water service piping unless approved by the

administrative authority and located at least two feet above the water table and at least ten feet from any sewer.

Subp. 2. **Underground stop valve.** On each water service from a street main to a building an approved gate valve or ground key stopcock shall be installed. This valve or stopcock shall be provided with an approved valve box and shall not be under the driveway. However, if there is an accessible stop valve in the street, no other stop is necessary underground.

Subp. 3. **Building valve.** Each building water service shall be provided with a gate valve or other full-way valve located inside the building near the point that the water service enters.

Subp. 4. **Meter valve.** A gate valve or other full-way valve shall be installed in the line on the discharge side of each water meter. The valve shall not be less in size than the building water supply.

Subp. 5. **Valves in dwelling units.** In each single or multiple unit dwelling, each family unit shall be controlled by an arrangement of shutoff valves which will permit each group of fixtures or the individual fixtures to be shut off without interference with the water supply to any other family unit or portion of the building.

Subp. 6. **Valves in buildings other than dwellings.** In all buildings other than dwellings, shutoff valves shall be installed, which permit the water supply to all equipment in each separate room or to each individual fixture to be shut off without interference with the water supply to any other room or portion of the building.

Subp. 7. **Valves for sill cocks.** All sill cocks and wall hydrants shall be separately controlled by a valve inside the building.

Subp. 8. **Tank controls.** Supply lines to and from pressure or gravity tanks shall be valved at or near the tanks.

Subp. 9. **Water heating equipment valve.** The cold water branch to each hot water storage tank or water heater shall be provided with a full way valve located near the equipment. Each tank or heater shall be equipped with an approved automatic relief valve as specified in parts 4715.2200 and 4715.2210.

Subp. 10. **Valves to be accessible.** All water supply control valves shall be placed so as to be accessible.

Subp. 11. **Control valve design.** Except to single fixtures, control valves on all water lines shall be full-way type and the same size as the line on which they are installed.

Subp. 12. **Yard hydrants.** Freeze-resistant sanitary yard hydrants must comply with ASSE 1057.

Statutory Authority: *MS s 326.37 to 326.45; 326B.43 to 326B.49*

History: *L 2007 c 140 art 6 s 15; art 13 s 4; 33 SR 2042*

4715.1810 WATER PRESSURE BOOSTER SYSTEMS.

Subpart 1. **Water pressure booster systems required.** When the water pressure in the public water main or individual water supply system is insufficient to supply the probable peak demand flow to all plumbing fixtures and other water needs freely and continuously with the minimum pressures and quantities specified in part 4715.1770, subpart 2 or elsewhere in this code and in accordance with good practice, the rate of supply shall be supplemented by an elevated water tank, a hydropneumatic pressure booster system, or a water pressure booster pump installed in accordance with subpart 5.

Subp. 2. **Support.** All water supply tanks shall be adequately supported.

Subp. 3. **Covers.** All water supply tanks shall be covered to keep out contaminants. The covers of gravity tanks shall be vented with a return bend vent pipe having an area not less than the area of the down feed riser pipe and the vent shall be screened with corrosion resistant screen of not less than 16 mesh.

Subp. 4. **Overflows for water supply tanks.** Each gravity or suction water supply tank shall be provided with an overflow having a diameter not less than shown in subpart 10. Sizes of overflow pipes for water supply tanks. The overflow outlet shall discharge above and within not less than six inches of a roof or roof drain, floor or floor drain, or over an open water supplied fixture. The overflow outlet shall be covered by a corrosion resistant screen of not less than 16 mesh.

Subp. 5. **Water supply to booster pumps.** When a booster pump is used on a water pressure booster system, it shall be supplied through a surge tank or if supplied through a direct connection, a low pressure cutoff switch (10 psi) and a vacuum relief valve or tank shall be installed on the suction side of the booster pump to prevent the creation of a vacuum or a negative pressure on the suction side of the pump. If installed below grade it shall be installed in a normally occupied area and on a pedestal at least 24 inches above the floor.

Subp. 6. **Potable water inlet to tanks.** Potable water inlets to gravity, surge, or break tanks shall be controlled by a ball cock or other automatic supply valve so installed as to prevent the tank from overflowing. The inlet shall be terminated so as to provide an accepted air gap but in no case less than four inches above the overflow.

Subp. 7. **Tank drain pipes.** Each tank shall be provided at its lowest point with a valved pipe to permit emptying the tank, which shall discharge as required for overflow pipes, and not smaller in size than shown in subpart 11.

Subp. 8. **Prohibited location of potable supply tanks.** Potable water tanks shall not be located directly under any soil or waste piping.

Subp. 9. **Pumps and other appliances.** Water pumps, filters, softeners, tanks, and all other devices and appliances used to handle or treat potable water shall be protected against contamination.

Subp. 10. **Sizes for overflow pipes for water supply tanks.**

Maximum Capacity of Water Supply Line to Tank	Diameter of Overflow Pipe (Inches ID)
0 - 50 gpm	2
50 - 150 gpm	2-1/2
100 - 200 gpm	3
200 - 400 gpm	4
400 - 700 gpm	5
700 - 1000 gpm	6
Over 1000 gpm	8

Subp. 11. **Size of drain pipes for water tanks.**

Tank Capacity (gallons)	Drain Pipe (inches)
Up to 750	1
751 to 1500	1-1/2
1501 to 3000	2
3001 to 5000	2-1/2
5001 to 7500	3
Over 7500	4

Statutory Authority: *MS s 326.37 to 326.45; 326B.43 to 326B.49*

History: *L 2007 c 140 art 6 s 15; art 13 s 4*

PROTECTION OF POTABLE WATER SUPPLY

4715.1900 DESIGN, MAINTENANCE, AND INSTALLATION.

A potable water supply system shall be designed, installed, and maintained in such manner as to prevent contamination from nonpotable liquids, solids, or gases, from being introduced into the potable water supply through cross-connection or any other piping connections to the system.

Statutory Authority: *MS s 144.12; 326.37 to 326.45; 326B.43 to 326B.49*

History: *L 2007 c 140 art 6 s 15; art 13 s 4*

4715.1910 IDENTIFICATION OF POTABLE AND NONPOTABLE WATER.

Subpart 1. **Identification methods.** In all buildings where dual water distribution systems, one potable water and other nonpotable water, are installed, each system shall be identified, either by color marking or metal tags.

Subp. 2. **Color marking.** When color marking is used, potable water lines should be painted green and nonpotable water lines should be painted yellow. This requirement may be met by painting three-inch-wide bands green or yellow at intervals of not more than 25 feet and at points where piping passes through walls, floors, or roofs in which case the bands shall be applied to the piping on both sides of the walls and both above and below the floor or roof. Points of outlets for nonpotable water shall be marked with a tag or color coded.

Subp. 3. **Metal tags.** When tags are used, potable water lines shall be identified by three-inch-diameter metal tags bearing the legend "SAFE WATER" in letters not less than one-half inch in height.

Nonpotable water lines shall be identified by firmly attached metal tags having the shape of a four-inch equilateral triangle bearing the legend "NONPOTABLE WATER" in letters not less than 7/16 inch in height.

As in the use of color bands, tags shall be attached to pipes at intervals of not more than 25 feet, and, at either side of points where pipes pass through walls and above and below points where pipes pass through floors or roofs.

Statutory Authority: *MS s 16B.59 to 16B.75; 326.37 to 326.45; 326B.101 to 326B.194; 326B.43 to 326B.49*

History: *23 SR 686; L 2007 c 140 art 4 s 61; art 6 s 15; art 13 s 4; L 2008 c 337 s 64*

4715.1911 TOXIC MATERIALS AND USED PIPE.

Piping conveying potable water shall be constructed of nontoxic material.

No material or substances that could produce either toxic conditions, taste, odor, or discoloration in a potable water system shall be introduced into or used in such systems.

The interior surface of a potable water tank shall not be lined, painted, or repaired with any material which will affect either the taste, odor, color, or potability of the water supply when the tank is placed in or returned to service.

Piping which has been used for any other purpose then conveying potable water shall not be used for conveying potable water.

Statutory Authority: *MS s 16B.61; 326.37 to 326.45; 326B.106; 326B.43 to 326B.49*

History: *15 SR 76; L 2007 c 140 art 4 s 61; art 6 s 15; art 13 s 4*

4715.1912 USED WATER RETURN PROHIBITED.

Water used for cooling of equipment or other processes shall not be returned to the potable water system. Such water shall be discharged into the drainage system through an air gapped indirect waste or other approved method of disposal.

Statutory Authority: *MS s 16B.61; 326.37 to 326.45; 326B.106; 326B.43 to 326B.49*

History: *15 SR 76; L 2007 c 140 art 4 s 61; art 6 s 15; art 13 s 4*

4715.1920 CROSS-CONNECTION CONTROL.

Cross-connections between potable water systems and other systems or equipment containing water or other substances of unknown or questionable safety are prohibited, except when and where, as approved by the authority having jurisdiction, suitable protective devices such as break tanks, reduced pressure zone backflow preventer, or equal, are installed, tested, and maintained to ensure proper operation on a continuing basis.

Cross-connections between an individual water supply and a potable public supply shall not be made unless specifically approved by the authority having jurisdiction.

Statutory Authority: *MS s 144.12; 326.37 to 326.45; 326B.43 to 326B.49*

History: *L 2007 c 140 art 6 s 15; art 13 s 4*

4715.1930 [Renumbered 4715.1911]**4715.1940 POTABLE WATER CONNECTIONS TO HEATING OR COOLING SYSTEMS.**

Potable water connections to boiler feed water systems, cooling systems, or other liquid systems, in which water conditioning chemicals may be introduced shall be made through an air gap or provided with an approved backflow preventer located in the potable water line before the point where such chemicals may be introduced. Where a system is filled with an antifreeze or toxic solution a permanent tag will be placed in plain view stating "Caution, this system contains antifreeze/toxic solution."

Statutory Authority: *MS s 16B.61; 326.37 to 326.45; 326B.106; 326B.43 to 326B.49*

History: *9 SR 1557; 15 SR 76; L 2007 c 140 art 4 s 61; art 6 s 15; art 13 s 4*

4715.1941 HEAT EXCHANGERS.

Subpart 1. **Construction requirement.** Devices utilizing any heat transfer medium to exchange thermal energy with potable water must be constructed so that a single failure of any wall in the system will not cause a cross-connection with or permit back siphonage of heat transfer medium into the potable water system.

Subp. 2. **Double-wall heat exchanger.** A double-wall heat exchanger must be designed in a way that any failure of a wall must allow the discharge to the atmosphere of the heat transfer medium or the potable water contained by the wall. The discharge location must be visible to the operator or owner of the system and be located so that no hazards are created by the discharge.

Subp. 3. **Single-wall heat exchanger.** A single-wall heat exchanger may be used if it satisfies all of the following conditions:

A. The heat transfer medium contains only substances which are recognized as safe or approved by the United States Food and Drug Administration for food contact as listed in Code of Federal Regulations, title 21, part 182 of the Food Additive Regulations.

B. Except where steam is used as the heat transfer medium, the pressure of the heat transfer medium must be less than the normal minimum operating pressure of the potable water system, and the system must be fitted with devices arranged to function automatically to maintain the pressure of the heat transfer medium entering the exchanger at a level below that of the potable water leaving the exchanger.

C. The equipment is permanently labeled to specify all constituents of the heat transfer medium, to indicate that only additives recognized as safe by the United States Food and Drug Administration may be used, and to show the hazards and reasons for not using another type of medium.

Statutory Authority: *MS s 16B.61; 326.37 to 326.45; 326B.106; 326B.43 to 326B.49*

History: *9 SR 1557; 15 SR 76; L 2007 c 140 art 4 s 61; art 6 s 15; art 13 s 4*

4715.1950 PROHIBITED CONNECTIONS TO FIXTURES AND EQUIPMENT.

Connections to the potable water supply system for the following shall be protected against backflow:

- A. bidets;
- B. operating, dissection, embalming, and mortuary tables or similar equipment; in such installation the hose used for water supply shall be equipped with a vacuum breaker installed at least six feet, six inches above the floor;
- C. pumps for nonpotable water, chemicals, or other substances; priming connections may be made only through an air gap;
- D. building drainage, sewer, or vent systems; and
- E. any other fixture of similar hazard.

Statutory Authority: *MS s 326.37 to 326.45; 326B.43 to 326B.49*

History: *L 2007 c 140 art 6 s 15; art 13 s 4*

4715.1960 REFRIGERATING UNIT CONDENSERS AND COOLING JACKETS.

Except where potable water provided for a refrigerator condenser or cooling jacket is entirely outside the piping or tank containing a toxic refrigerant, with two separate thicknesses of metal separating the refrigerant from the potable water supply, inlet connection shall be provided with an approved backflow preventer. Also, adjacent to and at the outlet side of the backflow preventer, an approved pressure relief valve set to relieve at 5 psi above the maximum water pressure at the point of installation shall be provided if the refrigeration units contain more than 20 pounds of refrigerants.

Statutory Authority: *MS s 16B.59; 16B.61; 16B.64; 326.37 to 326.45; 326B.101; 326B.106; 326B.13; 326B.43 to 326B.49*

History: *28 SR 146; L 2007 c 140 art 4 s 61; art 6 s 15; art 13 s 4*

4715.1970 [Renumbered 4715.1912]**PROTECTION OF POTABLE WATER AGAINST BACKFLOW AND BACK-SIPHONAGE****4715.2000 WATER OUTLETS.**

A potable water system shall be protected against backflow and back-siphonage by providing and maintaining at each outlet:

- A. an air gap as specified herein between the potable water outlet and the flood level rim of the fixture it supplies or between the outlet and any other source of contamination; or
- B. a backflow preventer device or assembly to prevent the drawing of contamination into the potable water system.

Statutory Authority: *MS s 16B.62; 326.37 to 326.45; 326B.121; 326B.43 to 326B.49*

History: *19 SR 590; L 2007 c 140 art 4 s 61; art 6 s 15; art 13 s 4*

4715.2010 MINIMUM REQUIRED AIR GAP.

Subpart 1. **Measurement.** The minimum required air gap shall be measured vertically from the lowest end of a potable water outlet to the flood rim or line of the fixture or receptacle into which it discharges.

Subp. 2. **Requirement.** The minimum required air gap shall be twice the effective opening of a potable water outlet unless the outlet is a distance less than three times the effective opening away from a wall or similar vertical surface in which cases the minimum required air gap shall be three times the effective opening of the outlet. In no case shall the minimum required air gap be less than shown in subpart 4.

Subp. 3. **Effect of walls, ribs, and similar obstructions.** Side walls, ribs, or similar obstructions do not affect air gaps when spaced from inside edge of spout opening a distance greater than three times the diameter of the effective opening for a single wall, or a distance greater than four times the diameter of the effective opening for two intersecting walls.

Vertical walls, ribs, or similar obstructions extending from the water surface to or above the horizontal plane of the spout opening require a greater air gap when spaced closer to the nearest inside edge of spout opening than specified in this subpart. The effect of three or more such vertical walls or ribs has not been determined. In such cases, the air gap shall be measured from the top of the wall.

Subp. 4. **Minimum air gaps for plumbing fixtures.**

Fixture	Minimum Air Gap	
	When Not Affected By Near Wall (1) (Inches)	When Affected By Near Wall (2) (Inches)
Lavatories and other fixtures with effective opening not greater than 1/2 inch diameter	1.0	1.50
Sink, Laundry trays, gooseneck bath faucets and other fixtures with effective openings not greater than 3/4 inch diameter	1.5	2.25
Over rim bath fillers and other fixtures with effective openings not greater than 1 inch diameter	2.0	3.0
Drinking water fountains	1.0	1.50
Effective openings greater than one inch	2x diameter of effective opening	3x diameter of effective opening

Statutory Authority: *MS s 326.37 to 326.45; 326B.43 to 326B.49*

History: *L 2007 c 140 art 6 s 15; art 13 s 4*

4715.2020 DEVICES OR ASSEMBLIES FOR THE PROTECTION OF THE POTABLE WATER SUPPLY.

Approved devices or assemblies to protect against backflow and back-siphonage must be installed at any plumbing fixture or equipment where backflow or back-siphonage may occur and where a minimum air gap cannot be provided between the water outlet to the fixture or equipment and its flood level rim.

Statutory Authority: *MS s 16B.61; 16B.62; 326.37 to 326.45; 326B.106; 326B.121; 326B.43 to 326B.49*

History: *15 SR 76; 19 SR 590; L 2007 c 140 art 4 s 61; art 6 s 15; art 13 s 4*

4715.2030 APPROVAL OF DEVICES OR ASSEMBLIES.

Before any device or assembly for the prevention of backflow or back-siphonage is installed, it shall have first been certified by a recognized testing laboratory acceptable to the administrative authority. Devices or assemblies installed in a building potable water supply

distribution system for protection against backflow shall be maintained in good working condition by the person or persons responsible for the maintenance of the system.

Statutory Authority: *MS s 16B.62; 326.37 to 326.45; 326B.121; 326B.43 to 326B.49*

History: *19 SR 590; L 2007 c 140 art 4 s 61; art 6 s 15; art 13 s 4*

INSTALLATION OF DEVICES

4715.2100 BACKFLOW PREVENTERS.

- A. Atmospheric vacuum breaker (AVB):
 - (1) must be installed at least six inches above spill line (see special requirements in part 4715.2150);
 - (2) no possibility of back pressure permitted;
 - (3) only permitted on discharge side of last control valve; and
 - (4) no more than eight hours of continuous line pressure permitted.
- B. Pressure vacuum breaker assembly (PVB):
 - (1) must be installed at least 12 inches above spill line;
 - (2) no possibility of back pressure permitted; and
 - (3) continuous line pressure permitted.
- C. Spill-proof vacuum breaker (SVB):
 - (1) must be installed at least six inches above spill line;
 - (2) no possibility of back pressure permitted;
 - (3) continuous line pressure permitted; and
 - (4) field testable.
- D. Hose connection vacuum breaker (Hose VB):
 - (1) required for threaded hose connections;
 - (2) back pressure not permitted;
 - (3) continuous line pressure not permitted; and
 - (4) any new device must be field testable. Exception: a vacuum breaker installed as an integral part of a product, approved to a standard, and installed at the factory will not be required to be field testable.
- E. Double-check valve with intermediate atmospheric vent (DCVIAV):
 - (1) permitted for low hazard with small pipe sizes;
 - (2) back pressure permitted; and
 - (3) continuous line pressure permitted.
- F. Reduced pressure zone backflow preventer assembly (RPZ):
 - (1) any degree of hazard permitted;
 - (2) back pressure permitted; and
 - (3) continuous line pressure permitted.
- G. Double-check valve assembly (DCVA):
 - (1) permitted only for nontoxic, low hazard installations with nuisance or aesthetic concern;
 - (2) back pressure permitted; and

MINNESOTA RULES 2011

887

PLUMBING CODE 4715.2110

(3) continuous line pressure permitted.

Statutory Authority: *MS s 16B.59 to 16B.75; 326.37 to 326.45; 326B.101 to 326B.194; 326B.43 to 326B.49*

History: *15 SR 76; 19 SR 590; 23 SR 686; 28 SR 146; L 2007 c 140 art 4 s 61; art 6 s 15; art 13 s 4; L 2008 c 337 s 64*

4715.2110 TYPES OF DEVICES REQUIRED WHERE AN AIR GAP CANNOT BE PROVIDED.¹

		Only allowed where no back pressure is possible					
		DCV		SVB or		Hose	
		RPZ	IAV	DCVA	PVB	AVB	VB
A.	Boiler, other than one- or two-family residential	X					
B.	Boiler, one- or two-family residential	X	X				
C.	Car wash	X			X	X	
D.	Carbonated beverage machine (postmix) (see part 4715.2163)		X				
E.	Chemical line	X					
F.	Chemical tank	X			X	X	
G.	Chiller	X					
H.	Cooling tower	X	X		X	X	
I.	Dental units (separate assembly required for each unit)	X					
J.	Dishwasher, commercial				X	X	
K.	Fire sprinkler system ²	X	X	X			
L.	Flush tank (water closet, urinal, similar) (see part 4715.2150)	X			X	X	
M.	Flush valve (water closet, urinal, similar) (see part 4715.2150)	X			X	X	
N.	Food and beverage equipment or system	X	X	X	X	X	
O.	Garbage can washer	X			X	X	
P.	Glycol or other antifreeze system	X					
Q.	Lab equipment	X			X	X	
R.	Lab faucet						X
S.	Laundry machine, commercial	X	X		X	X	
T.	Lawn, garden or greenhouse sprinkler system	X			X	X	
U.	Operating, dissection, embalming or mortuary table (see part 4715.1950)	X			X	X	
V.	Private potable water supply (where permitted by administrative authority)	X	X	X			
W.	Private nonpotable water supply (where permitted by administrative authority)	X					
X.	Process line	X	X				
Y.	Process tank	X			X	X	

4715.2110 PLUMBING CODE

888

Z.	RV dump station	X	X	X	X
AA.	Sewage treatment	X		X	X
BB.	Soap dispenser	X	X	X	X
CC.	Swimming pool, fountain, pond, baptistry, aquarium or similar	X	X	X	X
DD.	Threaded hose connections, including: hose bibbs, hydrants, service sinks, laundry trays				X ³ X
EE.	Truck fill	X		X	X
FF.	Vacuum systems or aspirators	X		X	X

1. For installations not listed in this part, review with the Administrative Authority.
2. Installations must comply with AWWA-M14, chapter 6 (1990) except that the following statement is deleted from section 6.3: At any time where the fire sprinkler piping is not an acceptable potable water system material, there shall be a backflow-prevention assembly isolating the fire sprinkler system from the potable water system.
3. A vacuum breaker installed as an integral part of a product approved to a standard does not require additional backflow prevention on the hose threads; the product must be constructed so that if the integral backflow preventer is removed, the remaining threads will not be hose thread type. An unprotected threaded hose connection must be protected against backflow by addition of a backflow preventer complying with ASSE 1052.

Statutory Authority: *MS s 16B.59 to 16B.75; 326.37 to 326.45; 326B.101 to 326B.194; 326B.43 to 326B.49*

History: *15 SR 76; 19 SR 590; 23 SR 686; 28 SR 146; L 2007 c 140 art 4 s 61; art 6 s 15; art 13 s 4; L 2008 c 337 s 64*

4715.2120 LOCATION OF BACKFLOW PREVENTERS.

Backflow and back-siphonage preventing devices or assemblies must be located so as to be readily accessible, preferably in the same room with the fixture they serve. Installation in utility or service spaces, provided they are readily accessible, is also permitted.

The access area must provide enough space for testing and maintenance of the device. A backflow preventer must not be installed in a pit or other confined area subject to flooding. When a conductor pipe is provided from a backflow preventer drain, a visible air gap must be provided at the device. New installations of reduced pressure zone backflow preventers must be at least 12 inches, but not more than six feet, above the finished floor or ground level.

Statutory Authority: *MS s 16B.59; 16B.61; 16B.62; 16B.64; 326.37 to 326.45; 326B.101; 326B.106; 326B.121; 326B.13; 326B.43 to 326B.49*

History: *15 SR 76; 19 SR 590; 28 SR 146; L 2007 c 140 art 4 s 61; art 6 s 15; art 13 s 4; 33 SR 2042*

4715.2130 [Repealed, 15 SR 76]

4715.2140 [Repealed, 15 SR 76]

4715.2150 CONNECTIONS NOT SUBJECT TO BACK PRESSURE.

Subpart 1. **Requirements.** Where a water connection is not subject to back pressure an atmospheric type vacuum breaker shall be installed on the discharge side of the last valve on the line serving the fixture or equipment. Where a valve is installed on the discharge side of a vacuum breaker, that vacuum breaker must be a pressure-type vacuum breaker assembly which complies with part 4715.2030. A list of some conditions requiring protective devices of this kind is given in subpart 2.

Subp. 2. **Cross-connections where protective devices are required and critical level (C-L) settings for backflow preventers.** Critical level (C-L) is defined as the level to which

MINNESOTA RULES 2011

889

PLUMBING CODE 4715.2160

the backflow preventer (vacuum breaker) may be submerged before backflow will occur. Where the C-L is not shown on the preventer, the bottom of the device shall be taken as the C-L.

Fixture or Equipment	Method of Installation
Aspirators and Ejectors	C-L at least 6 inches above flood level of receptacle.
Dental units	On models without built-in vacuum breakers C-L at least 6 inches above flood level rim of bowl.
Dishwashing machines	C-L at least 6 inches above flood level of machine. Install on both hot and cold water supply lines.
Flushometer (Closet & Urinal)	C-L at least 6 inches above top of fixture supplied.
Garbage can cleaning machine	C-L at least 6 inches above flood level of machine. Install on both hot and cold water supply lines.
Hose outlets	C-L at least 6 inches above highest point on hose line.
Laundry machines	C-L at least 6 inches above flood level of machine. Install on both hot and cold water supply lines.
Lawn sprinklers	C-L at least 12 inches above highest sprinkler or discharge outlet.
Steam tables	C-L at least 6 inches above flood level.
Tank and vats	C-L at least 6 inches above flood level rim or line.
Trough urinals	C-L at least 30 inches above perforated flush pipe.
Flush tanks	Equip with approved ball cock. Where ball cocks touch tank water equip with vacuum breaker with C-L at least 1 inch above overflow outlets. Where ball cock does not touch tank water, install ball cock outlet at least 1 inch above overflow outlet or provide vacuum breaker as specified above.
Hose bibbs (Where aspirators or ejectors could be connected)	C-L at least 6 inches above flood level of receptacle served.

Statutory Authority: *MS s 16B.62; 326.37 to 326.45; 326B.121; 326B.43 to 326B.49*

History: *19 SR 590; L 2007 c 140 art 4 s 61; art 6 s 15; art 13 s 4*

4715.2160 CONNECTIONS SUBJECT TO BACK PRESSURE.

Where a potable water connection is made to a line, fixture, tank, vat, pump, or other equipment with a hazard of backflow or back-siphonage, where the water connection is subject to back pressure, and an air gap cannot be installed, the administrative authority may require the use of break tank and booster pump or, where conditions permit, an approved reduced pressure zone backflow preventer. A partial list of such connections is as follows: chemical lines, dock water outlets, individual water supplies, industrial process water lines, pressure tanks, pumps, steam lines, and tanks and vats-bottom inlets.

Statutory Authority: *MS s 326.37 to 326.45; 326B.43 to 326B.49*

History: *L 2007 c 140 art 6 s 15; art 13 s 4*

4715.2161 INSTALLATION OF REDUCED PRESSURE BACKFLOW PREVENTERS.

Subpart 1. **Notification of installation.** The administrative authority must be notified before installation of a reduced pressure backflow preventer assembly.

Subp. 2. **Testing and maintenance.** The installation of reduced pressure backflow preventers shall be permitted only when a periodic testing and inspection program conducted by qualified personnel will be provided by an agency acceptable to the administrative authority. Inspection intervals shall not exceed one year, and overhaul intervals shall not exceed five years. The administrative authority may require more frequent testing if deemed necessary to assure protection of the potable water. Backflow preventers shall be inspected frequently after initial installation to assure that they have been properly installed and that debris resulting from the piping installation has not interfered with the functioning of the assembly.

Subp. 3. **Inspection and records.** A test and inspection tag must be affixed to the device. The tester shall date and sign the tag and include the tester's backflow preventer tester identification number. Written records of testing and maintenance must be maintained and submitted to the administrative authority.

Statutory Authority: *MS s 16B.61; 16B.62; 326.37 to 326.45; 326B.106; 326B.121; 326B.43 to 326B.49*

History: *15 SR 76; 19 SR 590; L 2007 c 140 art 4 s 61; art 6 s 15; art 13 s 4*

4715.2162 DOUBLE CHECK -- DOUBLE GATE VALVE ASSEMBLIES.

The administrative authority may authorize the installation of approved, double check -- double gate valve assemblies with test cocks as protective devices against back flow in connections between a potable water system and other nontoxic fluid systems which present no significant health hazards.

Statutory Authority: *MS s 16B.61; 326.37 to 326.45; 326B.106; 326B.43 to 326B.49*

History: *15 SR 76; L 2007 c 140 art 4 s 61; art 6 s 15; art 13 s 4*

4715.2163 CARBONATED BEVERAGE MACHINES.

Postmix type carbonated beverage machines must have an approved double-check valve with an intermediate atmospheric vent type backflow preventer in the water line preceding the carbonator. The backflow preventer must be installed in accordance with ASSE Standard 1022. There must be no copper tubing in the system down line of the backflow preventer.

Statutory Authority: *MS s 16B.59; 16B.61; 16B.64; 326.37 to 326.45; 326B.101; 326B.106; 326B.13; 326B.43 to 326B.49*

History: *15 SR 76; 28 SR 146; L 2007 c 140 art 4 s 61; art 6 s 15; art 13 s 4*

4715.2165 CHEMICAL/SOAP DISPENSING SYSTEMS.

The installation of backflow preventers for chemical/soap dispensing systems must comply with ASSE Standard 1055.

Exception: An atmospheric vacuum breaker integrally mounted on a faucet that is connected to a chemical/soap dispenser must be protected against back pressure by the installation of a pressure bleeding device and a backflow preventer complying with ASSE Standard 1052. The backflow preventer must be installed on the side outlet of the pressure bleeding device. No wye connector that has an integral shutoff may be connected to a faucet that has an integral atmospheric vacuum breaker.

Statutory Authority: *MS s 16B.59; 16B.61; 16B.64; 326.37; 326.40; 326B.101; 326B.106; 326B.13; 326B.43; 326B.46*

History: *28 SR 146; L 2007 c 140 art 4 s 61; art 6 s 15; art 13 s 4*

4715.2170 BAROMETRIC LOOP.

Water connections where an actual or potential backflow or back-siphonage hazard exists may in lieu of devices specified in parts 4715.2140 to 4715.2160 be provided with a barometric loop. Barometric loops shall precede the point of connection.

Statutory Authority: *MS s 326.37 to 326.45; 326B.43 to 326B.49*

History: *L 2007 c 140 art 6 s 15; art 13 s 4*

4715.2180 HOT WATER SUPPLY SYSTEM.

Hot water shall be supplied to all plumbing fixtures and equipment used for bathing, washing, culinary purpose, cleansing, laundry, or building maintenance, where necessary for proper functioning. Hot water supply systems in four-story buildings or buildings where the developed length of hot water piping from the source of hot water supply to the farthest fixture supplied exceeds 100 feet should be of the return circulation type, to conserve water.

Statutory Authority: *MS s 326.37 to 326.45; 326B.43 to 326B.49*

History: *L 2007 c 140 art 6 s 15; art 13 s 4*

4715.2190 COMBINATION WATER AND SPACE HEATING EQUIPMENT.

Equipment used for heating domestic or service hot water and for space heating must be installed with a mixing valve to permit the user to control the temperature of the domestic or service hot water regardless of the space heating demand.

The installation must include a drainage port and isolation valve to permit the user to purge the heating coils to waste after the nonheating season, or the system must be designed to automatically prevent stagnation.

The water heater must be specifically designated by the manufacturer for use as a combination hot water and space heater.

All pipes, joints, and appurtenances in the system must be of a type approved for potable water distribution. This provision is not intended to address the wall thickness of heating coils, which must be the responsibility of the manufacturer.

Statutory Authority: *MS s 16B.61; 326.37 to 326.45; 326B.106; 326B.43 to 326B.49*

History: *15 SR 76; L 2007 c 140 art 4 s 61; art 6 s 15; art 13 s 4*

4715.2200 PRESSURE RELIEF VALVES AND TEMPERATURE RELIEF VALVES DEVICES REQUIRED.

Equipment used for heating water or storing hot water shall be protected by approved safety devices in accordance with one of the following methods: a separate pressure relief valve and a separate temperature relief valve; or a combination pressure and temperature relief valve. All safety devices shall meet the current requirements of the A.N. Standards Institute, American Society of Mechanical Engineers, or the Underwriters Laboratories. Listing by Underwriters Laboratories, American Gas Association, or National Board of Boiler and Pressure Vessel Inspectors shall constitute evidence of conformance with these standards. Where a device is not listed by any of these, it must have certification by an approved laboratory as having met these requirements.

Statutory Authority: *MS s 326.37 to 326.45; 326B.43 to 326B.49*

History: *L 2007 c 140 art 6 s 15; art 13 s 4*

4715.2210 PRESSURE RELIEF VALVES.

Subpart 1. **Installation.** Pressure relief valves shall have a relief rating adequate to meet the pressure conditions in the equipment served. They shall be installed in the cold water supply line to the heating equipment served except where scale formation from hard water may be encountered in which case they may be installed in the hot water supply line from the heating equipment served. There shall be no shutoff valve between the pressure relief valve and the tank. The setting shall not exceed the tank working pressure.

4715.2210 PLUMBING CODE

892

Subp. 2. **Temperature relief valves.** Temperature relief valves shall be of adequate relief rating, expressed in Btu/hr, for the equipment served. They shall be installed so that the temperature sensing element is immersed in the hottest water in the head or within the top six inches of the vertical portion of the tank. The valve shall be set to open when the stored water temperature is 210 degrees Fahrenheit (or less).

Subp. 3. **Combination pressure-temperature relief valves.** Combination pressure temperature relief valves may be used for storage equipment provided the other applicable requirements for individual pressure and individual temperature relief valves are met.

Subp. 4. **Installation of relief valves.** No check valve or shutoff valve shall be installed between any safety device and the hot water equipment used, nor shall there be any shutoff valve in the discharge pipe from the relief valve. The discharge pipe shall be full size and run to within 18 inches of the floor or a safe place of disposal.

Statutory Authority: *MS s 16B.59 to 16B.75; 326.37 to 326.45; 326B.101 to 326B.194; 326B.43 to 326B.49*

History: *23 SR 686; L 2007 c 140 art 4 s 61; art 6 s 15; art 13 s 4; L 2008 c 337 s 64*

4715.2215 THERMAL EXPANSION CONTROL.

A device for controlling thermal expansion shall be installed on the water distribution system when thermal expansion within the system, in combination with a check valve or backflow preventer, causes the water pressure to exceed the pressure setting of the pressure relief valve on the water heater.

Statutory Authority: *MS s 16B.62; 326.37; 326B.121; 326B.43*

History: *19 SR 590; L 2007 c 140 art 4 s 61; art 6 s 15; art 13 s 4*

4715.2220 HOT WATER STORAGE TANKS.

Subpart 1. **Pressure marking of hot water storage tank.** Hot water storage tanks shall be permanently marked in an accessible place with the maximum allowable working pressure.

Subp. 2. **Drain cocks or valves for hot water storage tanks.** Drain cocks or valves for emptying shall be installed at the lowest point of each hot water storage tank.

Statutory Authority: *MS s 326.37 to 326.45; 326B.43 to 326B.49*

History: *L 2007 c 140 art 6 s 15; art 13 s 4*

4715.2230 TANKLESS AND INSTANTANEOUS TYPE HEATERS.

Tankless and instantaneous type water heaters require pressure relief valves only. Instantaneous electric water heaters that have Underwriters Laboratory approval for use without a relief valve, and that have space containing the heating element of less than three inches in diameter, may be installed without a pressure relief valve.

Statutory Authority: *MS s 16B.61; 326.37 to 326.45; 326B.106; 326B.43 to 326B.49*

History: *15 SR 76; L 2007 c 140 art 4 s 61; art 6 s 15; art 13 s 4*

4715.2240 ACCESS TO WATER HEATERS.

Every water heater installation shall be readily accessible for inspection, repair, or replacement. The appliance space shall be provided with an opening or doorway of sufficient size to provide such access.

Exception: A water heater with a tank capacity not greater than six gallons may be concealed in a ceiling space provided the water heater has been set in an overflow pan that has been constructed of a corrosion-resistant material, has side walls extending at least four inches upward, and has an outlet that shall not be sized less than the supply line to the water

heater. This outlet shall be piped undiminished in size to a point of safe disposal below the ceiling area. No tools shall be required to gain access to a water heater.

Statutory Authority: *MS s 16B.59 to 16B.75; 326.37 to 326.45; 326B.101 to 326B.194; 326B.43 to 326B.49*

History: *23 SR 686; L 2007 c 140 art 4 s 61; art 6 s 15; art 13 s 4; L 2008 c 337 s 64*

4715.2250 DISINFECTION OF POTABLE WATER SYSTEM.

New or repaired potable water systems shall be disinfected prior to use whenever required by the authority having jurisdiction. The method to be followed shall be that prescribed by the health authority or, in case no method is prescribed, the following:

A. the pipe system shall be flushed with clean, potable water until no dirty water appears at the points of outlet;

B. the system or part thereof shall be filled with a water chlorine solution containing at least 50 parts per million of chlorine and the system or part thereof shall be valved off and allowed to stand for 24 hours; or

C. the system or part thereof shall be filled with a water-chlorine solution containing at least 200 parts per million of chlorine and allowed to stand for three hours; and

D. following the allowed standing time the system shall be flushed with clean potable water until no chlorine remains in the water coming from the system.

Statutory Authority: *MS s 326.37 to 326.45; 326B.43 to 326B.49*

History: *17 SR 1279; L 2007 c 140 art 6 s 15; art 13 s 4*

4715.2260 [Renumbered 4715.2161]

4715.2270 [Renumbered 4715.2162]

4715.2280 WATER METER INSTALLATION.

Water meters shall be located inside a building and installed at least 12 inches above the finished floor and shall be readily accessible. Water meters installed within five feet of a plumbing fixture must be shielded from contamination. All water meter installations shall be rigidly supported with a permanent support in order to prevent the meter from vibrating when the water is passing through it. Water meter installations must also be approved by the authority having jurisdiction.

Exceptions: Where installation inside a building is not possible, the water meter may be installed in an enclosed structure not subject to flooding, high groundwater, or surface drainage runoffs, provided the meter is protected from freezing. Provision shall be made to install the meters above grade when possible. When installed below grade, the top of the structure shall be located at least 12 inches above the finished grade, be secured, and accessible. This structure shall not be connected to any storm or sanitary sewer system.

Statutory Authority: *MS s 16B.62; 326.37 to 326.45; 326B.121; 326B.43 to 326B.49*

History: *19 SR 590; L 2007 c 140 art 4 s 61; art 6 s 15; art 13 s 4; 33 SR 2042*

DETERMINING SIZE OF DRAINAGE SYSTEM

4715.2300 LOAD ON DRAINAGE PIPING.

Subpart 1. **Computation of drain load.** The load on drainage system piping shall be computed in terms of drainage fixture units in accordance with subparts 2, 2a, and 3, except the administrative authority may allow variations where it is shown by a hydraulic analysis of the piping system, submitted to the administrative authority, that such variation would result in a more desirable flow rate in the piping system.

Subp. 2. **Values for continuous flow.** Fixture unit values for continuous or semicontinuous flow into the drainage system, such as from a pump, sump ejector, air conditioning

MINNESOTA RULES 2011

4715.2300 PLUMBING CODE

894

equipment, or similar device shall be computed on the basis of one fixture unit for each gallon per minute flow.

Subp. 2a. **Values for intermittent flows.** Fixture unit values for intermittent flows from appliances and equipment which are specially designed for low water use, and used for retrofit in existing plumbing systems only, may be determined as follows:

Discharge Capacity (in gallons per minute)	Fixture Unit Value
up to 7-1/2	1 unit
8 to 15	2 units
16 to 30	4 units
31 to 50	6 units

A standpipe used for discharge from such appliances and equipment which is sized using these values must be labeled as intended for special low-water-use equipment only. Drainage piping in new construction must comply with subpart 3.

Subp. 3. **Table of fixture unit values for various plumbing fixtures.**

Type of Fixture	Fixture Unit Value	Minimum Fixture and Trap Drain Size
Clothes washer (domestic use)	2	1-1/2
Clothes washer (single unit, discharge to standpipe)	2	2
Clothes washer (public use in groups of 3 or more)	6 each	
Bath tub with or without shower	2	1-1/2
Bidet	2	1-1/2
Dental unit or cuspidor	1	1-1/4
Drinking fountain	1	1-1/4
Dishwasher, domestic (gravity drain)	2	1-1/2
Dishwasher, commercial	4	2
Floor drain with 2 inch waste	2	2
Floor drain with 3 inch waste	3	3
Floor drain with 4 inch waste	4	4
Lavatory	1	1-1/4
Laundry tray (1 or 2 compartment)	2	1-1/2
Shower stall, domestic	2	1-1/2
Shower (gang) per head	1	
SINKS:		
Classroom, with or without drinking fountain	2	1-1/2
Combination, sink and tray (with disposal unit)	3	1-1/2
Combination, sink and tray (with one trap)	2	1-1/2
Domestic	2	1-1/2
Domestic, with disposal unit	2	1-1/2
Surgeons	3	1-1/2
Laboratory, cup sink	1	1-1/2
Flushrim or bedpan washer	6	3
Service	3	2
Pot or scullery	4	2
Soda fountain	2	1-1/2

MINNESOTA RULES 2011

895

PLUMBING CODE 4715.2310

Commercial, flat rim, bar, or counter	3	1-1/2
Wash, circular, or multiple (per set of faucets)	2	1-1/2
URINAL pedestal, wall hung, with 3 inch trap (blowout and syphon jet)	6	3
Wall hung with 2 inch trap	3	2
Wall hung with 1-1/2 inch trap	2	1-1/2
Trough (per 6 foot section)	2	1-1/2
Stall	3	2
WATER CLOSET	6	3
Unlisted Fixture or Trap Size		
1-1/4 inch	1	
1-1/2 inch	2	
2 inch	3	
2-1/2 inch	4	
3 inch	5	
4 inch	6	

Statutory Authority: *MS s 16B.59 to 16B.75; 326.37 to 326.45; 326B.101 to 326B.194; 326B.43 to 326B.49*

History: *19 SR 590; 23 SR 686; L 2007 c 140 art 4 s 61; art 6 s 15; art 13 s 4; L 2008 c 337 s 64*

4715.2310 SELECTING SIZE OF GRAVITY DRAINAGE PIPING.

Subpart 1. **Determination of size.** Pipe sizes for gravity drains shall be determined from subparts 2 and 3 on the basis of drainage load computed from part 4715.2300, subparts 2 and 3.

Subp. 2. Maximum loads for horizontal drains in fixture units.

Building Sewer*****, Building Drain and
Building Drain Branches - from Stacks*****

Diameter of Drain	Horizontal Fixture Branch*-	Slope			
		1/16 in/ft. (f.u.)	1/8 in/ft. (f.u.)	1/4 in/ft. (f.u.)	1/2 in/ft. (f.u.)
(inches)	(f.u.)				
1-1/4	1				
1-1/2	3				
2	6			21	26
2-1/2	12			24	31
3**	32***		36***	42***	50***
4	160		180	216	250
5	360		390	480	575
6	620		700	840	1,000
8	--	1,400	1,600	1,920	2,300
10	--	2,500	2,900	3,500	4,200
12	--	3,900	4,600	5,600	6,700
15	--	7,000	8,300	10,000	12,000

*Includes Horizontal Branches of the Building Drain.

4715.2310 PLUMBING CODE

**No water closet shall discharge into a drain less than 3 inches.

***Not over 2 Water Closets.

****Every building drain that receives the discharge of (3) or more water closets, shall not be less than 4 inches in diameter.

*****No building sewer shall be less than 4 inches in diameter.

Subp. 3. **Maximum loads for soil and waste stacks in fixture units.**

Diameter of Stack	Stacks of not more than 3 stories or Branch Intervals	Stacks of more than 3 stories or Branch Intervals	Total at One Story or Branch Interval
1-1/4*	2	2	1
1-1/2*	4	4	2
2*	9	18	6
2-1/2*	20	42	9
3	36***	72***	24**
4	240	500	90
5	540	1,100	200
6	960	1,900	350
8	---	3,600	600
10	---	5,600	1,000
12	---	8,400	1,500

*No water closets permitted.

**Not over 2 water closets permitted.

***Not over 6 water closets permitted, and not over 6 branch intervals on a 3 inch soil stack.

Statutory Authority: *MS s 16B.59; 16B.61; 16B.64; 326.37 to 326.45; 326B.101; 326B.106; 326B.13; 326B.43 to 326B.49*

History: *28 SR 146; L 2007 c 140 art 4 s 61; art 6 s 15; art 13 s 4; 33 SR 2042*

4715.2320 MINIMUM SIZE OF SOIL AND WASTE STACKS.

No soil or waste stack shall be smaller than the largest horizontal branch connected thereto except that a four by three water closet connection shall not be considered as a reduction in pipe size.

Statutory Authority: *MS s 326.37 to 326.45; 326B.43 to 326B.49*

History: *L 2007 c 140 art 6 s 15; art 13 s 4*

4715.2330 MINIMUM SIZE OF STACK VENT OR VENT STACK.

Any structure in which a building drain is installed shall have at least one stack vent or vent stack carried full size through the roof not less than three inches in diameter. Where one or more soil stacks are required to extend through the roof undiminished in size they should be the stack or stacks most remote from the location where the building drain leaves the building. When a soil or waste stack receives the discharge of fixtures located on two or more floors, and the uppermost fixture is located three or more floors above the building drain, such stack and stack vent shall continue undiminished in size through the roof. For purposes of this part, "floor" means any building floor level which is above the floor level of the building drain.

Statutory Authority: *MS s 16B.59 to 16B.75; 326.37 to 326.45; 326B.101 to 326B.194; 326B.43 to 326B.49*

History: *23 SR 686; L 2007 c 140 art 4 s 61; art 6 s 15; art 13 s 4; L 2008 c 337 s 64*

4715.2340 PROVISION FOR FUTURE FIXTURES.

When provision is made for future installation of fixtures, those provided for shall be considered in determining the required sizes of drain and vent pipes. Construction to provide for such future installations shall be terminated with a plugged fitting or fittings.

Statutory Authority: *MS s 326.37 to 326.45; 326B.43 to 326B.49*

History: *L 2007 c 140 art 6 s 15; art 13 s 4*

4715.2350 MINIMUM SIZE OF UNDERGROUND DRAINAGE PIPING.

No portion of the drainage system installed underground shall be less than two inches in diameter.

Statutory Authority: *MS s 326.37 to 326.45; 326B.43 to 326B.49*

History: *L 2007 c 140 art 6 s 15; art 13 s 4*

4715.2360 SIZING OF OFFSETS ON DRAINAGE PIPING.

Subpart 1. **Offsets of 45 degrees or less.** An offset in a vertical stack with a change of direction of 45 degrees or less from the vertical may be sized as a straight vertical stack.

Subp. 2. **Offsets of more than 45 degrees.** A stack with an offset of more than 45 degrees from the vertical shall be sized as follows:

A. The portion of the stack above the offset shall be sized as for a regular stack based on the total number of fixture units above the offset.

B. The offset shall be sized as for a building drain branch, part 4715.2310, subpart 2.

C. The portion of the stack below the offset shall be sized at least as large as the offset.

Subp. 3. **Above highest branch.** An offset above the highest branch connection is an offset in the stack vent and shall be considered only as it affects the developed length of the vent.

Subp. 4. **Below lowest branch.** In the case of an offset in a soil or waste stack below the lowest branch connection, there shall be no change in diameter required if the offset is made at an angle of not greater than 45 degrees from the vertical.

If such offset is made at an angle of greater than 45 degrees from the vertical, the required diameter of the offset and the stack below it shall be sized as for a building drain. (Part 4715.2310, subpart 2.)

Statutory Authority: *MS s 326.37 to 326.45; 326B.43 to 326B.49*

History: *L 2007 c 140 art 6 s 15; art 13 s 4*

4715.2370 FIXTURE CONNECTIONS TO AN OFFSET OF MORE THAN 45 DEGREES OR AT BASE OF STACK.

When stacks in buildings of five or more stories in height receive the discharge of fixtures four or more stories above the offset, no fixtures on the floor at which the offset occurs shall be connected to the stack within eight feet of the base of the offset measured vertically or horizontally. Said fixtures may also be connected into vertical section of the stack more than two feet below the offset. Fixture connections to horizontal piping at the bases of such stacks shall be made in the same manner, or at a point acceptable to the administrative authority.

Statutory Authority: *MS s 326.37 to 326.45; 326B.43 to 326B.49*

History: *L 2007 c 140 art 6 s 15; art 13 s 4*

DRAINAGE PIPING INSTALLATION**4715.2400 PITCH ON HORIZONTAL DRAINAGE PIPING.**

Horizontal drainage piping shall be installed in uniform alignment at uniform slopes in accordance with the following requirements and in no case at a slope which will produce a computed velocity of less than two feet per second, unless otherwise permitted by the administrative authority, based on hydraulic analysis of the piping system.

Size of Piping	Minimum Slope
Less than 3 inches	1/4 inch per foot
3 inches to 6 inches	1/8 inch per foot
8 inches and over	1/16 inch per foot

Statutory Authority: *MS s 16B.59; 16B.61; 16B.64; 326.37; 326.40; 326B.101; 326B.106; 326B.13; 326B.43; 326B.46*

History: *28 SR 146; L 2007 c 140 art 4 s 61; art 6 s 15; art 13 s 4*

4715.2410 CHANGE IN DIRECTION.

Changes in direction in drainage piping shall be made by the appropriate use of 45 degree wyes, long or short sweep quarter bends, sixth, eighth, or sixteenth bends, or by combination of these or equivalent fittings. Single and double sanitary tees, quarter bends, and long turn ells may be used in drainage lines only where the direction of the flow is from the horizontal to the vertical. Short sweep bends or long turn ells three inch or larger in diameter may be used in soil or waste lines where the change in direction of flow is from either the horizontal to the vertical or from the vertical to the horizontal.

Statutory Authority: *MS s 326.37 to 326.45; 326B.43 to 326B.49*

History: *L 2007 c 140 art 6 s 15; art 13 s 4*

4715.2420 PROHIBITED FITTINGS AND CONNECTIONS.

Subpart 1. **General prohibitions.** No fittings having a hub in the direction opposite to flow, or straight tee branch shall be used as a drainage fitting. No fitting or connection which has an enlargement chamber or recess with a ledge or shoulder, or reduction in pipe area shall be used. No manhole shall be used to join drainage piping within a building. No drainage or vent piping shall be drilled, tapped, or welded unless otherwise permitted by the administrative authority. Fittings used for back-to-back, wall outlet, blowout type water closet bowls shall have a baffle plate or other device to prevent the waste water from one water closet from entering the opposite water closet. No fixture connection shall be made to a closet bend. No running threads, bands, or saddles shall be used. The short pattern fitting in a horizontal position is prohibited in underground work.

Subp. 2. **Heel or side-inlet bends.** A heel or side-inlet quarter bend shall not be used as a vent when the inlet is placed in a horizontal position or any similar arrangement of pipe or fittings producing a similar effect.

Subp. 3. **Obstruction to flow.** No fitting, connection, device, or method of installation which obstructs or retards the flow of water, wastes, sewage, or air in the drainage or venting system in an amount greater than the normal frictional resistance to flow shall be used unless it is indicated as acceptable to this code by having a desirable and acceptable function and as of ultimate benefit to the proper and continuing functioning of the plumbing system. The enlargement of a three-inch closet bend or stub to four inches shall not be considered an obstruction, provided the horizontal flow line or insert is continuous without forming a ledge.

Subp. 4. **Dead ends.** In the installation of a drainage system, dead ends shall be avoided except where necessary to extend piping for a cleanout so as to be accessible.

Statutory Authority: *MS s 326.37 to 326.45; 326B.43 to 326B.49*

History: *L 2007 c 140 art 6 s 15; art 13 s 4; 33 SR 2042*

4715.2430 DRAINS BELOW BUILDING SEWER.

Only drains that cannot be discharged to the sewer by gravity flow shall discharge into an approved watertight, gas-tight vented sump or receiving tank, so located as to receive the sewage or wastes by gravity. From the sump or receiving tank the sewage or other liquid wastes shall be lifted and discharged into the building gravity drain by approved automatic pumping equipment. The system or drainage piping entering the sump shall be installed and vented as required in this section for a gravity system.

Statutory Authority: *MS s 326.37 to 326.45; 326B.43 to 326B.49*

History: *9 SR 1557; L 2007 c 140 art 6 s 15; art 13 s 4; 33 SR 2042*

4715.2440 DESIGN OF SUMPS.

Subpart 1. **Construction.** Sumps and receiving tanks shall be constructed of poured concrete, metal, or other approved materials. If constructed of poured concrete, the walls and bottom shall be adequately reinforced and designed to acceptable standards. Metal sumps or tanks shall be of such thickness as to serve their intended purpose and shall be treated internally and externally to resist corrosion.

Subp. 2. **Discharge line.** The discharge line from such pumping equipment shall be provided with an accessible backwater valve and gate valve, and if the gravity drainage line to which such discharge line connects is horizontal, the method of connection shall be from the top through a wye branch fitting. The minimum size of any pump or discharge pipe from a sump having a water closet connected thereto shall not be less than two inches.

Subp. 3. **Sumps for buildings.** Building drains or building sewers receiving discharge from any pumping equipment shall be adequately sized to prevent overloading. In all buildings, other than single- and two-family dwellings, should three or more water closets discharge into the sump, duplicate pumping equipment shall be installed.

Subp. 4. **Covers.** Sumps and receiving tanks must be provided with gastight covers, except that float control or switch rods must operate without binding. The cover must be of a bolt and gasket type or equivalent manhole opening to permit access for inspection, repairs, and cleaning. Covers must be metal or other structurally sound material that is water-resistant and impervious to moisture, and must be adequate to support anticipated loads in the area of use.

Subp. 5. **Single-family dwellings.** In single-family dwellings the minimum capacity of a sump shall be 18 gallons.

Subp. 6. **Sump vent.** The top of the sump tank shall be provided with a vent pipe which shall extend separately through the roof, or may be combined with other vent pipes. Such vent shall be large enough to maintain atmospheric pressure within the sump under all normal operating conditions and in no case less than in accordance with the number of fixture units discharging into the sump. When the foregoing requirements are met and the vent, after leaving the sump, is combined with vents from fixtures discharging into the sump, the size of the combined vent need not exceed that required for the total number of fixtures discharging into the sump. No vent from an air operated sewage ejector shall combine with other vents.

Subp. 7. **Clear water sumps.** Sumps and receiving tanks which receive only clear water drainage, and from which sewage is excluded, need not be airtight or vented. Sumps and receiving tanks must be provided with covers fastened or secured so as to prevent entry by children. The covers must be adequate to support anticipated loads in area of use.

In nonresidential buildings guard rails constructed in accordance with chapter 1305, Minnesota Building Code, may be used in lieu of covers.

Statutory Authority: *MS s 16B.59 to 16B.75; 326.37 to 326.45; 326B.101 to 326B.194; 326B.43 to 326B.49*

History: *9 SR 1557; 15 SR 76; 19 SR 590; 23 SR 686; 28 SR 146; L 2007 c 140 art 4 s 61; art 6 s 15; art 13 s 4; L 2008 c 337 s 64*

VENTS AND VENTING

4715.2500 SELECTING SIZE OF VENT PIPING.

Subpart 1. **Size determined.** Vent pipe sizes shall be determined from part 4715.2520, subparts 5 and 6, on the basis of length and drainage load computed from part 4715.2300, subparts 2 and 3.

Subp. 2. **Minimum diameter of vent piping.** No vent pipe shall be less than 1-1/4 inches in diameter.

Subp. 3. **Individual vents.** The diameter of the individual vents shall be determined from part 4715.2520, subpart 6, but shall in no case be less than one-half the diameter of the fixture drain served.

Subp. 4. **Relief and yoke vents.** The diameter of relief and yoke vents shall be at least one-half the diameter of the soil and waste branch or stack served, nor less than the size of the vent to which they are connected.

Subp. 5. **Circuit or loop vents.** The diameter of circuit or loop vents shall be at least one-half the diameter of the horizontal soil or waste branch to which they connect. Maximum developed length as shown for fixture units in part 4715.2520, subpart 6. See part 4715.2600.

Subp. 6. **Branch vents.** The diameter of branch vents connecting more than one individual vent to a vent stack or stack vent shall be in accordance with part 4715.2520, subpart 6. The branch vent size shall be based upon the number of fixture units connected thereto, and the developed length of the branch vent measured from its vent stack (or stack vent) connection to the farthest fixture drain connection served by the branch vent.

Subp. 7. **Vent headers.** The diameter of vent headers shall be in accordance with part 4715.2520, subpart 6. The vent header size shall be based upon the sum of the fixture unit loads at the stacks vented through such section of the header, and the developed length shall be that of the vent stack having the longest developed length to the open air.

Subp. 8. **Vent stacks.** The diameter of the vent stacks shall be determined from part 4715.2520, subpart 5, based upon the size of the soil or waste stacks served thereby, the number of fixture units connected to the soil or waste stack, and the developed length of the vent stack. Such developed length shall be measured from the lowest connection of the vent stack with the soil or waste stack to the open air.

Statutory Authority: *MS s 326.37 to 326.45; 326B.43 to 326B.49*

History: *L 2007 c 140 art 6 s 15; art 13 s 4*

4715.2510 PROTECTION OF TRAP SEALS.

The protection of trap seals from siphonage or back pressure shall be accomplished by the appropriate use of soil or waste stacks or vents, installed in accordance with requirements of this chapter, so that at no time the trap shall be subjected to a pressure differential of more than one inch of water.

Statutory Authority: *MS s 326.37 to 326.45; 326B.43 to 326B.49*

History: *L 2007 c 140 art 6 s 15; art 13 s 4*

4715.2520 VENT STACKS AND STACK VENTS.

Subpart 1. **Vent stack required.** For each sanitary building sewer, at least one three-inch vent stack (or stack vent) carried full size through the roof shall be installed as provided

MINNESOTA RULES 2011

901

PLUMBING CODE 4715.2520

in part 4715.2330. A vent stack or main vent shall be installed with a soil or waste stack whenever individual vents, relief vents, or branch vents are required for stacks of three or more branch intervals.

Subp. 2. Connections at base and top. For stacks of three or four branch intervals in height, all main vents or vent stacks shall connect full size at their base to the main soil or waste stack below, through, or not more than 18 inches above the lowest fixture branch.

For stacks of five or more branch intervals in height, a main vent or vent stack shall connect full size with the soil or waste stack it serves, with a wye and one-eighth bend below the lowest fixture branch connected to such soil or waste stack, or at a point approved by the administrative authority.

Each such soil or waste stack, and vent stack shall be similarly cross-connected with a yoke vent at intervals of not more than five branch intervals as described in part 4715.2640.

Subp. 3. Offsets for stacks of five or more branch intervals or stories. As provided in part 4715.2360, soil and waste stacks offset at an angle of more than 45 degrees from the vertical, that receive the discharge of fixtures four or more branch intervals or stories above the offset, shall have a yoke vent installed (as per part 4715.2640) at the base of the upper stack section.

Subp. 4. Vent headers. Where stack vents and vent stacks are connected into a vent header, such connections shall be made at the tops of the stacks. The vent header shall connect to a vent extension through the roof.

Subp. 5. Size and lengths of vent stacks.

SIZE OF SOIL OR WASTE STACK IN INCHES	FIX-TURE UNITS CON-NECTED in d. f. u.	DIAMETER OF VENT IN INCHES										
		1-1/4	1-1/2	2	2-1/2	3	4	5	6	8	10	12
		MAXIMUM DEVELOPED LENGTH OF VENT, IN FEET										
1-1/4	2	50										
1-1/2	4	40	200									
2	9		100	200								
2	18		50	150								
2-1/2	42		30	100	300							
3	72			50	80	400						
4	240			40	70	250						
4	500				50	180	700					
5	540					150	600					
5	1100					50	200	700				
6	1900						50	200	700			
8	2200							150	500			
8	3600							60	250	800		
10	3800								200	600		
10	5600								60	250	800	
12	6000									200	600	

MINNESOTA RULES 2011

4715.2520 PLUMBING CODE 902

12	8400		100	300	900
15	10500		50	200	600
15	50000			75	180

Subp. 6. Size and length of vents; individual, branch, circuit, and header.

Fixture Units connected in d.f.u.	Diameter of Vent, in Inches							
	1-1/4	1-1/2*	2	2-1/2	3	4	5	6
	Maximum Developed Length of Vent, in Feet							
2	50	ul						
4	40	200	ul					
8	np	150	250					
10		100	200	ul				
24		50	150	400	ul			
42		30	100	300	500			
72		np	50	80	400			
240			np	50	200	ul		
500				np	180	700	ul	
1100					50	200	700	

*Except 6 fixture unit fixtures.

ul -- Unlimited length.

np -- Not permitted.

Statutory Authority: *MS s 16B.59 to 16B.75; 326.37 to 326.45; 326B.101 to 326B.194; 326B.43 to 326B.49*

History: *23 SR 686; 28 SR 146; L 2007 c 140 art 4 s 61; art 6 s 15; art 13 s 4; L 2008 c 337 s 64; 33 SR 2042*

4715.2530 VENT TERMINALS.

Subpart 1. **Extension above roofs.** Extension of vent pipes through a roof shall be terminated not less than 12 inches above it. Where a roof is to be used for any purpose other than weather protection, the vent extensions shall be run at least seven feet above the roof.

Subp. 2. **Waterproof flashings.** Each vent terminal shall be made watertight with the roof by proper flashing of copper, lead, galvanized iron, or other approved flashings or flashing materials. Vent pipe terminals shall pass through the roof and shall be at least two inches in diameter. When approved by the administrative authority, other materials or methods may be used which provide adequate protection.

Subp. 3. **Location of vent terminal.** No vent terminal shall be located directly beneath any door, window, or other ventilating opening of the building or of an adjacent building nor shall any such vent terminal be within ten feet horizontally of such an opening unless it is at least two feet above the top of such opening.

Subp. 4. **Terminals adjoining high buildings.** In the event that a new building is built higher than an existing building, the owner of the new building shall not locate openable windows, doors, or other ventilating openings within ten feet of any existing vent stack on

the lower building unless the owner of such new building shall defray the expenses or shall make such alterations to conform to part 4715.2530, subpart 3.

Statutory Authority: *MS s 326.37 to 326.45; 326B.43 to 326B.49*

History: *17 SR 1279; L 2007 c 140 art 6 s 15; art 13 s 4*

4715.2540 VENT GRADES AND CONNECTIONS.

Subpart 1. **Vent grade.** All vent and branch vent pipes shall be so graded and connected as to drain back to a soil or waste pipe by gravity.

Subp. 2. **Vertical rise.** Where vent pipes connect to a horizontal soil or waste pipe, the vent shall be taken off above the center line of the pipe. The vent pipe shall rise vertically, or at an angle not more than 45 degrees from the vertical, to a point at least six inches above flood-level rim of the fixture it is venting, before offsetting horizontally or before connecting to the branch vent.

Subp. 3. **Height above fixtures.** A connection between a vent pipe and a vent stack or stack-vent shall be made at least six inches above the flood-level rim of the highest fixture served by the vent. Horizontal vent pipes forming branch vents, relief vents, or loop vents shall be at least six inches above the flood-level rim of the highest fixture served.

Statutory Authority: *MS s 326.37 to 326.45; 326B.43 to 326B.49*

History: *L 2007 c 140 art 6 s 15; art 13 s 4*

4715.2550 WET VENTING.

Subpart 1. **Single bathroom groups.** A single bathroom group of fixtures may be installed with the drain from a backvented lavatory, kitchen sink, or combination fixture serving as a wet vent for a bathtub or shower stall provided that:

- A. not more than one fixture unit is drained into a 1-1/2 inch diameter wet vent or not more than four fixture units drain into a two inch diameter wet vent; and
- B. the horizontal branch drain connects to the stack at or below the same level as the water closet drain when installed on the top floor.

Subp. 2. **Double bathroom groups back-to-back.** Bathroom groups back-to-back consisting of two lavatories and two bathtubs or shower stalls may be installed on the same horizontal branch with a common vent for the lavatories and with no back vent for the bathtubs or shower stalls, provided the wet vent is not less than two inches in diameter.

Subp. 3. **Basement shower.** A basement shower may be wet vented through the waste from a laundry tub, lavatory, or sink, provided the wet vent is not less than two inches in diameter, and the drain conforms to part 4715.2620, subpart 4.

Subp. 4. **Basement and cellar closet.** A basement or cellar lavatory may be connected to a properly installed vent from a floor set, basement or cellar, water closet, provided the vent is not less than two inches in diameter.

Statutory Authority: *MS s 326.37 to 326.45; 326B.43 to 326B.49*

History: *L 2007 c 140 art 6 s 15; art 13 s 4*

4715.2560 STACK VENTING.

A group of fixtures consisting of one bathroom group and a kitchen sink or combination fixture may be installed without individual fixture vents at the uppermost branch interval of a stack, if each fixture drain connects independently to a stack at least three inches in diameter extended full size through the roof, and bathtub or shower stall drain enters the stack at or above the same level as the water closet drain, and in accordance with requirements in part 4715.2620, subpart 4. Where the trap arm distances are exceeded the fixtures must be revented. When a water closet discharges to a sanitary tee in the vertical position, and a bathtub or shower on the same floor level also discharges to the sanitary tee through a side

4715.2560 PLUMBING CODE

904

inlet, the water closet vent must be at least three inches in size unless the bathtub or shower is revented.

Statutory Authority: *MS s 16B.59 to 16B.75; 326.37 to 326.45; 326B.101 to 326B.194; 326B.43 to 326B.49*

History: *11 SR 1405; 23 SR 686; L 2007 c 140 art 4 s 61; art 6 s 15; art 13 s 4; L 2008 c 337 s 64*

4715.2570 INDIVIDUAL FIXTURE REVENTING REQUIRED.

When fixtures other than water closets discharge downstream from a water closet, each fixture connecting downstream shall be individually vented, under provisions set down in this code.

Statutory Authority: *MS s 326.37 to 326.45; 326B.43 to 326B.49*

History: *L 2007 c 140 art 6 s 15; art 13 s 4*

4715.2580 COMMON VENTS.

Subpart 1. **Individual vent as common vent.** An individual vent, installed vertically, may be used as a common vent for not more than two traps serving a single fixture or two traps serving similar fixtures when both fixture drains connect independently with a vertical drain at the same level.

Subp. 2. **Fixtures connected to vertical drain at different levels.** Except for water closets or similar fixtures, a common vent may be used for two fixtures set on same floor level but connecting at different levels in the vertical drain, provided the vertical drain is one pipe diameter larger than the upper fixture drain but in no case smaller than the lower fixture drain, whichever is the larger and that both drains conform to part 4715.2620, subpart 4. No more than two fixture traps shall be vented in this manner.

Statutory Authority: *MS s 16B.59 to 16B.75; 326.37 to 326.45; 326B.101 to 326B.194; 326B.43 to 326B.49*

History: *23 SR 686; L 2007 c 140 art 4 s 61; art 6 s 15; art 13 s 4; L 2008 c 337 s 64; 33 SR 2042*

4715.2600 CIRCUIT AND LOOP VENTING.

Subpart 1. **Battery venting.** A branch or waste pipe to which two, but not more than eight water closets (except blowout type) are connected in battery, may be vented by circuit or loop vent which shall be taken off in front of the last fixture connection of the battery. When the battery consists of not more than four closets, the vent shall be two inches; when the battery consists of five or six closets, the vent shall be 2-1/2 inches; and when the battery consists of seven or eight closets, the vent shall be three inches. In addition, lower floor branches shall be provided with a relief vent which shall be the same size as the branch vent, taken off in front of the first fixture connection of the battery. When lavatories, or similar fixtures discharge into such branches, each vertical branch from such fixtures shall be provided with a continuous vent. When closets are installed back to back, such installation shall be as per subpart 2 or 4.

Subp. 2. **Dual branches.** When parallel horizontal branches serve a total of eight water closets (four on each branch), each branch shall be provided with a relief vent at a point between the two most distant water closets. When fixtures such as lavatories discharge into the horizontal branch drain, each such fixture shall be vented.

Subp. 3. **Vent connections.** When the circuit, loop, or relief vent connections are taken off the horizontal branch, the vent branch connection shall be taken off at a vertical angle or from the top of the horizontal branch.

Subp. 4. **Fixtures back-to-back in battery.** When fixtures are connected to one horizontal branch through a double wye or a sanitary cross in a vertical position, a common vent

for each two fixtures back-to-back or double connection shall be provided. The common vent shall be installed in a vertical position as a continuation of the double connection.

Statutory Authority: *MS s 16B.59 to 16B.75; 326.37 to 326.45; 326B.101 to 326B.194; 326B.43 to 326B.49*

History: *23 SR 686; L 2007 c 140 art 4 s 61; art 6 s 15; art 13 s 4; L 2008 c 337 s 64*

4715.2610 FIXTURES BACK-TO-BACK.

Two fixtures set back-to-back, within the distance allowed between a trap and its vent, may be served with one continuous soil or waste-vent pipe, provided that each fixture wastes separately into an approved double fitting, having inlet openings at the same level. (See part 4715.2580, subpart 1.)

Statutory Authority: *MS s 326.37 to 326.45; 326B.43 to 326B.49*

History: *L 2007 c 140 art 6 s 15; art 13 s 4; 33 SR 2042*

4715.2620 FIXTURE VENTS.

Subpart 1. **Distance of trap from vent.** Each fixture trap shall have a protecting vent so located that the slope and the developed length in the fixture drain from the trap weir to the vent fitting are within the requirements set forth in subpart 4.

Subp. 2. **Trap dip.** The vent pipe opening from a soil or waste pipe, except for water closets and similar fixtures, shall not be below the weir of the trap.

Subp. 3. **Crown venting limitation.** No vent shall be installed within two drain pipe diameters of the trap weir.

Subp. 4. **Distance of fixture trap from vent.**

Size of Fixture Drain, Inches	Distance Trap to Vent
1-1/4	2 ft 6 in
1-1/2	3 ft 6 in
2	5 feet
3	6 feet
4	10 feet

Note: The developed length between the trap of the water closet or similar fixture and its vent shall not exceed four feet.

Statutory Authority: *MS s 326.37 to 326.45; 326B.43 to 326B.49*

History: *L 2007 c 140 art 6 s 15; art 13 s 4; 33 SR 2042*

4715.2630 VENTS FOR FIXTURE TRAP BELOW TRAP DIP.

Fixture drains shall be vented within the hydraulic gradient between the trap outlet and vent connection, but in no case shall the unvented drain exceed the distance provided for in part 4715.2620, subpart 4.

Statutory Authority: *MS s 326.37 to 326.45; 326B.43 to 326B.49*

History: *L 2007 c 140 art 6 s 15; art 13 s 4*

4715.2640 YOKE VENTS FOR STACKS OF MORE THAN FIVE BRANCH INTERVALS.

Soil and waste stacks in buildings having more than five branch intervals shall be provided with a relief vent at each fifth interval installed, beginning with the top floor. The size of the relief vent shall be equal to the size of the vent stack to which it connects. The lower end of the yoke vent shall connect to the soil or waste stack through a wye and one-eighth bend located below the horizontal branch drain serving fixtures on that floor and the upper

4715.2640 PLUMBING CODE

906

end shall connect to the vent stack through a tee or inverted wye not less than three feet above the floor level.

Statutory Authority: *MS s 326.37 to 326.45; 326B.43 to 326B.49*

History: *L 2007 c 140 art 6 s 15; art 13 s 4*

4715.2650 COMBINATION WASTE AND VENT SYSTEM.

Subpart 1. **Where permitted.** A combination waste-and-vent system shall be permitted only where structural conditions preclude the installation of a conventional system as otherwise provided in this code.

Subp. 2. **Limits of use.** A combination waste-and-vent system is limited to floor drains and sinks which will not be used for greasy wastes. It consists of an installation of waste piping in which the trap of the fixture is not individually vented. Every drainage pipe and trap in the waste and vent system shall be at least two pipe sizes larger than the size required in part 4715.2310. Vents shall be provided at both ends of the system.

Subp. 3. [Repealed, 28 SR 146]

Statutory Authority: *MS s 16B.59; 16B.61; 16B.64; 326.37; 326.40; 326B.101; 326B.106; 326B.13; 326B.43; 326B.46*

History: *28 SR 146; L 2007 c 140 art 4 s 61; art 6 s 15; art 13 s 4*

4715.2655 ISLAND FIXTURE VENTING.

Traps for island sinks and similar equipment may be vented, when structural conditions preclude the use of conventional vents, by extending the vent as high as possible under the sink enclosure and then returning it downward and connecting it to the horizontal drain through a wye branch fitting downstream from the vertical fixture drain. In addition, a horizontal vent must be taken off the vertical section of the fixture vent by means of a wye branch fitting and extended to the partition where it can be extended vertically to the open air or connected to another vent at least six inches above the flood level of the fixture served. Drainage fittings must be used on all sections of the vent below floor level and a minimum slope of one-fourth inch per foot to the drainage point shall be provided. Cleanouts must be provided on the vent piping.

Statutory Authority: *MS s 16B.59; 16B.61; 16B.64; 326.37; 326.40; 326B.101; 326B.106; 326B.13; 326B.43; 326B.46*

History: *28 SR 146; L 2007 c 140 art 4 s 61; art 6 s 15; art 13 s 4*

4715.2660 VENTING OF SUMPS AND SEWERS.

Drainage piping below sewer level shall be vented in similar manner to that for a gravity system. Building sump vents shall be sized in accordance with parts 4715.2520, subpart 6, and 4715.2440, subpart 6, but in any case not less than 1-1/2 inches. Vents from pneumatic ejectors, flammable waste traps, or similar equipment shall be terminated separately at the open air.

Statutory Authority: *MS s 326.37 to 326.45; 326B.43 to 326B.49*

History: *L 2007 c 140 art 6 s 15; art 13 s 4*

STORM DRAINS

4715.2700 STORM SEWER SYSTEMS.

All roofs shall be drained into a separate storm sewer system, or a combined sewer system where such systems are available, or to a place of disposal satisfactory to the administrative authority. In no case shall water from roofs be allowed to flow upon the public sidewalk. Storm water shall not be drained into sewers intended for sanitary sewage only.

Statutory Authority: *MS s 326.37 to 326.45; 326B.43 to 326B.49*

History: *L 2007 c 140 art 6 s 15; art 13 s 4*

MINNESOTA RULES 2011

907

PLUMBING CODE 4715.2710

4715.2710 SIZE OF BUILDING STORM DRAINS AND LEADERS.

Subpart 1. **Size of building storm drain.** The size of the building storm drain or any of its horizontal branches having a slope of one-half inch or less per foot, shall be based upon the maximum projected roof or paved area to be handled according to subpart 4.

Subp. 2. **Size of vertical leaders.** Vertical leaders shall be sized on the maximum projected roof area, according to subpart 5.

Subp. 3. **Reduction in size prohibited.** Storm drain piping shall not reduce in size in the direction of flow, including changes in direction from horizontal to vertical.

Subp. 4. **Size of horizontal storm drains.**

Diameter of Drain Inches	Maximum Projected Roof Area for Drains of Various Slopes		
	1/8 in. Slope Square Feet	1/4 in. Slope Square Feet	1/2 in. Slope Square Feet
3	822	1,160	1,644
4	1,880	2,650	3,760
5	3,340	4,720	6,680
6	5,350	7,550	10,700
8	11,500	16,300	23,000
10	20,700	29,200	41,400
12	33,300	47,000	66,600
15	59,500	84,000	119,000

Use a rate of rainfall of four inches per hour for sizes not listed in this table.

Subp. 5. **Size of vertical leaders.**

Size of Leader or Conductor Inches	Maximum Projected Roof Area Square Feet
2	720
2-1/2	1,300
3	2,200
4	4,600
5	8,650
6	13,500
8	29,000

Use a rate of rainfall of four inches per hour for sizes not listed in this table.

The equivalent diameter of square or rectangular leader may be taken as the diameter of that circle which may be inscribed within the cross-sectional area of the leader.

Subp. 6. **Values for continuous flow.** If there is a continuous or semicontinuous discharge into the building storm drain or building storm sewer, as from a pump, ejector, or similar device, each gallon per minute of the discharge must be computed as being equivalent to 24 square feet of roof area, based upon a four-inch rainfall.

Statutory Authority: *MS s 16B.59 to 16B.75; 326.37 to 326.45; 326B.101 to 326B.194; 326B.43 to 326B.49*

History: *23 SR 686; L 2007 c 140 art 4 s 61; art 6 s 15; art 13 s 4; L 2008 c 337 s 64; 33 SR 2042*

4715.2720 PLUMBING CODE

908

4715.2720 SUBSOIL DRAINS.

When the subsoil drain for a building is subject to backwater, it shall be protected by an accessibly located backwater valve. Subsoil drains may discharge into a properly trapped area drain or sump. Such sumps do not require vents. (See parts 4715.2430 and 4715.2440.)

Statutory Authority: *MS s 326.37 to 326.45; 326B.43 to 326B.49*

History: *L 2007 c 140 art 6 s 15; art 13 s 4*

4715.2730 BUILDING SUBDRAINS.

Building subdrains, receiving subsoil drainage, located below the public sewer level shall discharge into a sump or receiving tank the contents of which shall be automatically lifted and discharged into the drainage system as required for building sumps. (See parts 4715.2430 and 4715.2440.)

Statutory Authority: *MS s 326.37 to 326.45; 326B.43 to 326B.49*

History: *L 2007 c 140 art 6 s 15; art 13 s 4*

4715.2740 TRAPS ON STORM DRAINS AND LEADERS.

No traps shall be required for storm water drains which are connected to a sewer carrying storm water exclusively.

Leaders and storm drains that are connected to a combined sewer shall be trapped if:

A. the drain is located within ten feet of any door, window, or other opening into an occupied area; and

B. an outside leader of sheet metal is connected to the storm drain and the joint of connection is within ten feet of any door, window, or other opening into an occupied area. Such connection shall be at least six inches above grade. The trap shall be located inside the building and be provided with an accessible cleanout.

Statutory Authority: *MS s 326.37 to 326.45; 326B.43 to 326B.49*

History: *L 2007 c 140 art 6 s 15; art 13 s 4*

4715.2750 CONDUCTORS AND CONNECTIONS.

Subpart 1. **Not to be used improperly.** Conductor pipes shall not be used as soil, waste, or vent pipes nor shall drainage or vent pipes be used as conductors.

Subp. 2. **Separate storm and sanitary drainage.** The sanitary and storm building drains shall be separate and shall be run to a point at least five feet outside the building. The sanitary and storm building sewers shall be separate except where a combined sewer is available and where permitted by local authorities they may be joined together preferably in a manhole prior to discharging to a combined sewer. The sizing of the combined building sewer shall conform to good engineering practices and be acceptable to the administrative authority.

Statutory Authority: *MS s 326.37 to 326.45; 326B.43 to 326B.49*

History: *L 2007 c 140 art 6 s 15; art 13 s 4*

4715.2760 ROOF AND DECK DRAINS.

Subpart 1. **Roof drain strainers.** All roof areas, except those draining to hanging gutters, shall be equipped with roof drains having strainers extending not less than four inches above the surface of the roof immediately adjacent to the roof drain. Strainers shall be provided on all overflow roof drains and shall have an available inlet area, above roof level, equal to that of the conductor or leader to which the drain is connected.

Exceptions: For roof drains with integral overflow drains meeting Standard IAPMO IGC 187-05, a strainer with a minimum height of three inches shall be provided and the structural design of the roof for maximum ponding and the design of the engineered roof drain sumps shall be certified by a state-licensed professional structural engineer.

Subp. 2. **Overflow drains.** For overflow drains refer to chapter 1305, Minnesota Building Code.

Subp. 3. **Flat deck and area drains.** Drain strainers for use on sun decks, and similar area, normally serviced and maintained, may be of the flat surface type, level with the deck and shall have an available inlet area of not less than two times the area of the conductor or leader to which the drain is connected.

Subp. 4. **Roof drain flashings required.** The connection between roofs and roof drains which pass through the roof and into the interior of the building shall be made watertight by use of proper flashing material.

Statutory Authority: *MS s 16B.59 to 16B.75; 326.37 to 326.45; 326B.101 to 326B.194; 326B.43 to 326B.49*

History: *23 SR 686; 28 SR 146; L 2007 c 140 art 4 s 61; art 6 s 15; art 13 s 4; L 2008 c 337 s 64; 33 SR 2042*

4715.2770 PROVISIONS FOR EXPANSION.

Expansion joints, sleeves, or suitable offsets shall be provided where warranted by temperature variations or physical conditions.

Statutory Authority: *MS s 326.37 to 326.45; 326B.43 to 326B.49*

History: *L 2007 c 140 art 6 s 15; art 13 s 4*

4715.2780 CONTROL FLOW STORM WATER DRAINAGE FOR DEAD LEVEL ROOFS.

Subpart 1. **General requirements.** In lieu of sizing the storm drainage system from conventional methods as previously described in this chapter, the roof drainage may be sized on the controlled flow and storage of the storm water on the roof provided the following conditions are met:

A. the roof drainage system shall be sized on the basis of a rate of rainfall of four inches per hour;

B. the roof is dead level and 45 degree cants, properly flashed, are installed at any well or parapet;

C. the roof design is based on a minimum of 40 pounds per square foot live load, with overflow line of roof edge, coping, or relieving scupper in parapet wall at least four inches in height above the roof and at no greater height than will provide a safety factor of two for the structural design live load;

D. roof drainage pipe sizing may be designed on the basis of controlled flow sizing tables provided by manufacturers of roof drains approved by the administrative authority or by the tables in subparts 2 and 3;

E. the plans or specifications for the storm drainage system shall indicate the method used as the basis for the design.

Subp. 2. **Size of vertical leaders.**

Size of Leader Inches	Maximum Projected Roof Area in Square Feet
3	7,500
4	15,000
5	21,000

Roof areas of more than 15,000 square feet shall contain two or more roof drains.

Subp. 3. **Size of horizontal storm drains.**

Diameter of Drain Inches	Maximum Projected Roof Area in Square Feet 1/4 in. Slope
3	3,500
4	8,200
5	11,750
6	18,500
8	40,000
10	75,850
12	118,000
15	214,000

Statutory Authority: *MS s 326.37 to 326.45; 326B.43 to 326B.49*

History: *L 2007 c 140 art 6 s 15; art 13 s 4*

INSPECTION, TESTS, AND MAINTENANCE

4715.2800 INSPECTIONS.

New plumbing systems and parts of existing systems which have been altered, extended, or repaired shall be inspected and tested by the proper administrative authority to ensure compliance with all the requirements of this code and the installation and construction of the system in accordance with the approved plan and the permit, except that testing may be waived for work which does not include addition to, replacement, alteration, or relocation of any water supply, drainage, or vent piping.

All the piping shall be tested and after the plumbing fixtures have been set, and before the system is put into use, the system shall be given a final inspection and test by the proper administrative authority.

The equipment, material, power, and labor necessary for the inspection must be furnished by the plumbing contractor.

Statutory Authority: *MS s 16B.59 to 16B.75; 326.37 to 326.45; 326B.101 to 326B.194; 326B.43 to 326B.49*

History: *23 SR 686; L 2007 c 140 art 4 s 61; art 6 s 15; art 13 s 4; L 2008 c 337 s 64*

4715.2810 NOTIFICATIONS.

It shall be the duty of the plumbing contractor to notify the proper administrative authority and the owner or the owner's authorized agent orally, by telephone, or in writing, not less than eight working hours between the hours of 8:00 a.m. and 4:00 p.m. before the work is to be inspected or tested. It shall be the duty of the plumbing contractor to make sure that the work will stand the test prescribed before giving the above notification. If the proper administrative authority finds that the work will not stand the test, the plumbing contractor shall be required to renotify as above. If the proper administrative authority does not appear for an inspection within 24 hours of the time set, excluding Saturdays, Sundays, and holidays, the inspection or test shall be deemed to have been made, and the plumbing contractor is required to file an affidavit with the proper administrative authority that the work was installed in accordance with the code, the approved plans and permit, and that it was free from defects and that the required tests had been made and the system found free from leaks; also whether the owner or the owner's authorized agent was present when such inspection or test was made.

Statutory Authority: *MS s 326.37 to 326.45; 326B.43 to 326B.49*

History: *17 SR 1279; L 2007 c 140 art 6 s 15; art 13 s 4*

4715.2820 METHOD OF TESTING.

Subpart 1. **Testing.** The tests shall be applied to the plumbing drainage system in its entirety or in sections. Sections which are found satisfactory need not be retested after completion of the entire system unless considered necessary by the proper administrative authority.

Subp. 2. **Rough plumbing.** The piping of plumbing drainage and venting systems shall be tested upon completion of the rough piping. The method of testing shall be specified by the designer and shall either be an air test or hydrostatic test as described in this subpart or an alternative test as approved by the administrative authority. The air test shall be made by attaching the air compressor or testing apparatus to any suitable opening and closing all other inlets and outlets to the system by means of proper testing plugs. Plaster of paris shall not be used in roof terminals. Air shall be forced into the system until there is a uniform pressure of five pounds per square inch on the portion of the system being tested. The pressure shall remain constant for 15 minutes without the addition of air.

The hydrostatic test for thermoplastic piping materials shall be conducted by tightly closing all openings in the entire system to be tested except the highest opening. The system shall be filled with water to the point of overflow. If the system is tested in sections, each opening shall be tightly plugged except the highest opening of the section under test. Each section shall be filled with water, but a section shall not be tested with less than ten foot head of water. In testing successive sections, at least the upper ten feet of the next preceding section shall be tested, so that no joint or pipe in the building, except the uppermost ten feet of the system, is subjected to a test of less than ten foot head of water. The water shall be kept in the system or in the portion under test for at least 15 minutes before inspection begins. The system shall be tight at all points.

In lieu of five pound air test, concrete manholes and sewer lines may be tested by negative pressure in accordance with ASTM Standards C1214-92 and C1244-93.

Subp. 2a. Exceptions.

A. Testing is not required for:

- (1) outside leaders;
- (2) perforated or open drain tile; or
- (3) portions of storm sewers located more than ten feet from buildings, more than ten feet from buried water lines, and more than 50 feet from water wells, and not passing through soil or water identified as being contaminated.

B. Building storm sewers may be tested in accordance with the Hydrostatic Test Method from the City Engineers Association of Minnesota, except that an air test may be required for any section of the building storm sewer that passes through contaminated soils or contaminated water. The Hydrostatic Test Method, provisions H2 and H3, as specified in Standard Utilities Specifications for Watermain and Service Line Installation and Sanitary Sewer and Storm Sewer Installation, written and published by the City Engineers Association of Minnesota, 1988 edition, is incorporated by reference, is not subject to frequent change, and is available in the office of the commissioner of administration.

Subp. 3. **Finished plumbing.** After the plumbing fixtures have been set and their traps filled with water, their connections shall be tested and proven gas and water tight by plugging the stack openings on the roof and the building drain where it leaves the building, and air introduced into the system equal to the pressure of a one inch water column. Such pressure shall remain constant for the period of inspection without the introduction of additional air.

Subp. 4. **Conductor pipes.** Conductor pipes and their roof connections inside the building shall be tested with air. (See subpart 2)

Subp. 5. **Test of water distribution system.** Upon the completion of a section or of the entire water distribution system, it shall be tested and proved tight with the use of air or

4715.2820 PLUMBING CODE

912

water not less than the maximum working pressure under which it is to be used. If tested with water, the water used for the test shall be obtained from a potable source.

Subp. 6. **Material and labor for tests.** The equipment, material, power, and labor necessary for the inspection and test shall be furnished by the plumbing contractor.

Subp. 7. **Test plugs or caps.** Test plugs or caps for roof terminals must extend above or outside the end of the vent pipe to provide a visible indication for removal after the test has been completed.

Statutory Authority: *MS s 16B.59 to 16B.75; 326.37 to 326.45; 326B.101 to 326B.194; 326B.43 to 326B.49*

History: *19 SR 590; 23 SR 686; 28 SR 146; L 2007 c 140 art 4 s 61; art 6 s 15; art 13 s 4; L 2008 c 337 s 64; 33 SR 2042*

4715.2830 COVERING OF WORK.

No building drainage or plumbing system or part thereof shall be covered until it has been inspected, tested, and approved as herein prescribed.

If any building drainage or plumbing system or part thereof is covered before being regularly inspected, tested, and approved, as herein prescribed, it shall be uncovered upon the direction of the proper administrative authority.

Statutory Authority: *MS s 326.37 to 326.45; 326B.43 to 326B.49*

History: *L 2007 c 140 art 6 s 15; art 13 s 4*

4715.2840 DEFECTIVE WORK.

If the inspection or test shows defects, such defective work or material shall be replaced and the inspection and test repeated.

All installed fixtures found defective or in an insanitary condition shall be repaired, replaced, or removed upon written notice from the proper administrative authorities.

Statutory Authority: *MS s 326.37 to 326.45; 326B.43 to 326B.49*

History: *L 2007 c 140 art 6 s 15; art 13 s 4*

4715.2850 AIR TEST OF DEFECTIVE PLUMBING.

The air test shall be used in testing the sanitary condition of the drainage or plumbing system of all buildings where there is reason to believe that it has become defective. In buildings condemned by the proper administrative authority because of insanitary conditions of the plumbing system, the alterations in such system shall not be considered as repairs, but as new plumbing.

Where buildings are moved from one location to another, or raised for foundations, or where part of the plumbing system has been damaged by fire, storm, or other means, a final air test shall be applied and shall hold tight, if in the opinion of the administrative authority it is warranted in order to assure a sanitary plumbing system.

Statutory Authority: *MS s 326.37 to 326.45; 326B.43 to 326B.49*

History: *L 2007 c 140 art 6 s 15; art 13 s 4*

4715.2860 MAINTENANCE.

The plumbing system of every building shall be maintained in a sanitary and safe operating condition.

Statutory Authority: *MS s 326.37 to 326.45; 326B.43 to 326B.49*

History: *L 2007 c 140 art 6 s 15; art 13 s 4*

4715.2870 DISINFECTION OF WATER PIPING.

See part 4715.2250.

Statutory Authority: *MS s 326.37 to 326.45; 326B.43 to 326B.49*

History: *L 2007 c 140 art 6 s 15; art 13 s 4*

4715.2880 BUILDING SEWER.

The building sewer shall be inspected by the proper administrative authority to ensure compliance with the provisions of the code.

Statutory Authority: *MS s 326.37 to 326.45; 326B.43 to 326B.49*

History: *L 2007 c 140 art 6 s 15; art 13 s 4*

4715.2890 CERTIFICATE OF APPROVAL.

Upon the satisfactory completion and final inspection of the plumbing system, a certificate of approval shall be issued by the proper administrative authority.

Statutory Authority: *MS s 326.37 to 326.45; 326B.43 to 326B.49*

History: *L 2007 c 140 art 6 s 15; art 13 s 4*

PLUMBERS AND PLUMBING; REQUIREMENTS**4715.3130 PLANS AND SPECIFICATIONS.**

Prior to the installation by any person, corporation, or public agency, of a system of plumbing that serves the public or that serves any considerable number of persons, or any plumbing system that shall affect the public health in any manner, complete plans and specifications, together with any additional information that the commissioner of health may require, shall be submitted in duplicate and approved by the commissioner. The appraisal of the commissioner shall reflect the degree to which these plans and specifications affect the public health and conform to the provisions of the Minnesota Plumbing Code. No constructions shall proceed except in accordance with approved plans. Any material alteration or extension of the existing system shall be subject to these same requirements. This rule shall not apply to cities of the first class, except those plumbing installations in hospitals or in buildings in these cities owned by the federal or the state government.

There shall be no physical connection between water supply systems that are safe for domestic use and those that are unsafe for domestic use. There shall be no apparatus through which unsafe water may be discharged or drawn into a safe water supply system.

Statutory Authority: *MS s 326.37 to 326.45; 326B.43 to 326B.49*

History: *L 2007 c 140 art 6 s 15; art 13 s 4*

4715.3140 [Repealed, 33 SR 2042]

4715.3150 [Repealed, 33 SR 2042]

4715.3160 [Repealed, 33 SR 2042]

4715.3170 [Repealed, 33 SR 2042]

EXPLANATORY MATERIALS**4715.3500 GENERAL.**

Parts 4715.3500 to 4715.3700 outline a procedure for the sizing of the water supply piping. The design procedure is based on the minimum pressure available from the street main or individual source of supply, the head changes in the system due to friction and elevation, the volume rates of flow required for satisfactory operation of the fixtures, and the probability of simultaneous use.

Statutory Authority: *MS s 326.37 to 326.45; 326B.43 to 326B.49*

History: *L 2007 c 140 art 6 s 15; art 13 s 4*

4715.3600 TOTAL DAILY WATER REQUIREMENTS.

Subpart 1. **Basic needs.** The calculation of total daily requirements for water may be based on the unit quantities shown in subparts 2 and 3. The total daily water requirement does not constitute the peak or simultaneous water requirement of the supply and shall not be used in sizing water distribution systems. The total of the daily water requirement shall be used only to determine whether the source of the water supply is sufficient to provide the water requirements of people, animals, irrigation, and other water using facilities served. The rate of flow and pressures at which the total daily water requirements shall be delivered shall be determined as prescribed hereinafter.

Subp. 2. **Design criteria for daily water requirements based on building occupancy.**

Type of occupancy	Minimum quantity of water per person per day in gallons (or as indicated)
Small dwellings and cottages with seasonal occupancy	50
Single family dwellings	75
Multiple family dwellings (apartments)	60
Rooming houses	40
Boarding houses	50
Additional kitchen usage for nonresident boarders	10
Hotels without private baths	50
Hotels with private baths (2 persons per room)	60
Restaurants (toilet and kitchen usage per patron)	7 to 10
Restaurants (kitchen usage per meal served)	2-1/2 to 3
Additional for bars and cocktail lounges	2
Tourist camps or trailer parks with central bathhouse	35
Tourist camps or mobile home parks with individual bath units	50
Resort camps (night and day) with limited plumbing	50
Luxury camps	100 to 150
Work or construction camps (semipermanent)	50
Camp (with complete plumbing)	45 (Ind.w.s.)
Camp (with flush toilets--no showers)	25 (Ind.w.s.)
Day camps (no meals served)	15
Day schools, without cafeterias, gymnasiums, or showers	15
Day schools with cafeterias, but no gymnasiums or showers	20
Day schools with cafeterias, gymnasiums and showers	25
Boarding schools	75 to 100
Day workers at schools and offices (per shift)	15
Hospitals (per bed)	150 to 250
Institutions other than hospitals (per bed)	75 to 125
Factories (gallons per person per shift, exclusive of industrial wastes)	15 to 35
Picnic parks (toilet usage only) (gallons per picnicker)	5
Picnic parks with bathhouses, showers, and flush toilets	10
Swimming pools and bathhouses	10
Luxury residences and estates	100 to 150

MINNESOTA RULES 2011

915

PLUMBING CODE 4715.3600

Country clubs (per resident member)	100
Country clubs (per nonresident member)	25
Motels (per bed space)	40
Motels with bath, toilet, and kitchen range	50
Drive-in theaters (per car space)	5
Movie theaters (per auditorium seat)	5
Airports (per passenger)	3 to 5
Self-service laundries (gallons per wash, i.e., per customer)	50
Stores (per toilet room)	400
Service stations (per vehicle serviced)	10

Subp. 3. Daily water requirements for common farm animals.

Animal	Minimum daily water requirements in gallons
Horse, mule, or steer	12
Dairy cow (drinking only)	15
Dairy cow (drinking and dairy servicing)	35
Sheep	2
Hog	4
Chickens (100)	4
Turkeys (100)	7

Subp. 4. **Calculating total daily requirement.** Total daily water requirements should be calculated by multiplying the unit daily requirement by the total number of persons in the occupancy involved. See subpart 6. To this figure must be added any special use quantity, such as lawn watering, industrial requirement, etc.

Subp. 5. **Special requirements.** The total daily amount of any special requirement shall be added to the figure as obtained under subpart 4. Part 4715.1770, subpart 2 gives special use quantities for some conditions. While the quantity of special use water shall be computed on the rates given in part 4715.1770, subpart 2, the total amount shall be figured for appropriate periods and conditions of use. See subpart 7.

Subp. 6. **Example 1.** Example: assume there is a hospital outside the limits of a community. The hospital has 300 beds. In addition, the hospital supplies its own dairy products and has a farm with 40 head of cattle. In subpart 2, the daily water requirement per hospital bed is taken as 250 gallons per bed. From subpart 3, the water requirement per head of cattle is taken as 35 gallons per animal. Therefore the total daily water requirement is 300×250 plus 40×35 or 76,400 gallons.

Subp. 7. **Example 2.** Example: it is assumed that at the hospital cited in subpart 6 there is a lawn sprinkling system operating from 12 sill cocks three hours each day. From part 4715.1770, subpart 2 it is seen that each sill cock requires 300 gallons per hour. Therefore, the total special use water will equal $12 \times 300 \times 3$ or 10,800 gallons. This amount is added to that obtained in subpart 6. The total quantity required is, therefore, 76,400 plus 10,800 or 87,200 gallons per day.

Statutory Authority: *MS s 326.37 to 326.45; 326B.43 to 326B.49*

History: *L 2007 c 140 art 6 s 15; art 13 s 4*

4715.3700 DETERMINATION OF PEAK DEMAND.

Subpart 1. **Estimating water supply demand.** In determining the size of water supply distribution piping, the maximum momentary volume rate of flow of water shall first be determined. This is the supply demand which is based on the numbers and kinds of fixtures installed, on the rates of flow required by the different kinds of fixtures, and on the probable simultaneous operation of the various fixtures. The total daily requirements do not enter into this determination. In computing supply demand, use shall be made of subpart 2.

Subp. 2. Supply fixture unit values for various plumbing fixtures.

Fixture of group ¹	Type of supply control	Supply fixture unit values		
		Hot	Cold	Total ²
Bathroom group	Flush valve	3	6	8
Bathroom group	Flush tank	3	4.5	6
Bathtub	Faucet	1.5	1.5	2
Combination fixture	Faucet	2	2	3
Kitchen sink	Faucet	1.5	1.5	2
Laundry tray	Faucet	2	2	3
Lavatory	Faucet	1.5	1.5	2
Pedestal urinal	Flush valve		10	10
Restaurant sink	Faucet	3	3	4
Service sink	Faucet	1.5	1.5	2
Shower head	Mixing valve	3	3	4
Stall or wall urinal	Flush valve		5	5
Stall or wall urinal	Flush tank		3	3
Water closet	Flush valve		10	10
Water closet	Flush tank		5	5

¹For fixtures not listed, factors may be assumed by comparing the fixture to a listed one using water in similar quantities and at similar rates.

²For fixtures with both hot and cold water supplies, the weights for maximum separate demands may be taken as three-fourths of the total supply fixture unit value.

Subp. 3. **Calculation of demand.** When the water supply fixture units are used to estimate the supply demand, the supply fixture unit values as given in subpart 2 shall be used in conjunction with subpart 4.

MINNESOTA RULES 2011

917

PLUMBING CODE 4715.3700

Subp. 4. Supply demand for various loads in supply fixture units.

Load	Supply demand	
	Flush valve water closets predominate (subpart 5, curve 1)	Tank water closets predominate (subpart 5, curve 2)
Supply fixture units:	gpm	gpm
5	22	4
10	27	8
20	35	14
30	42	20
40	46	24
50	51	28
60	54	32
88	64	40
124	74	48
160	81	56
226	98	72
300	108	85
400	127	106
470	135	118
500	143	124
600	157	143
660	162	152
700	170	161
800	183	178
850	189	185
900	197	195
1,000	208	208
1,060	216	216
1,280	243	243
1,510	270	270
1,990	324	324
2,480	378	378
2,990	432	432

Subp. 5. Graph of supply demand for various loads in supply fixture units.

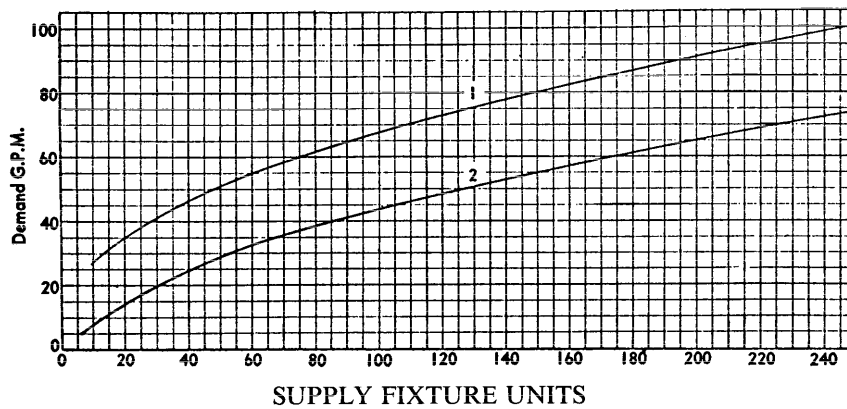
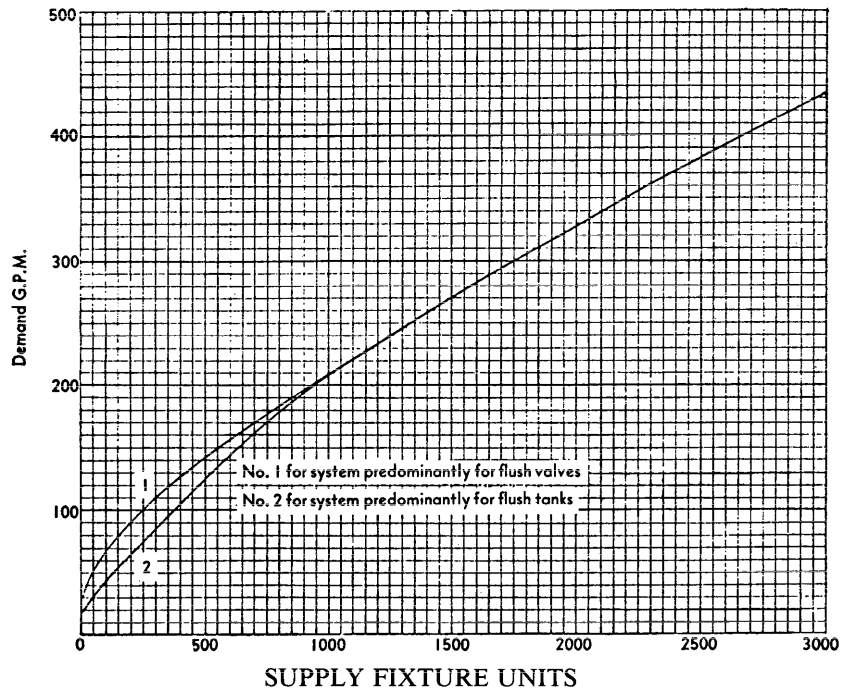

The estimated demand load in gallons per minute for fixtures used intermittently on any water supply pipe shall be obtained by multiplying the total number of each kind of fixture, supplied through that pipe by its supply fixture unit value from subpart 2, adding the products, and then, referring to the appropriate columns of subpart 4, or using subpart 5, select the demand in GPM. Examples are given below. The additional load of any continuously flowing outlets such as hose outlets shall be computed separately and added to the total demand of intermittently used fixtures. See subpart 6.

MINNESOTA RULES 2011

919

PLUMBING CODE 4715.3700

Subp. 6. **Example.** Assume a water line serving a public washroom in which are three flushometer pedestal urinals, six flushometer closets and six lavatories with hot and cold water. First prepare a tabulation as shown.

Name of plumbing fixture	Number on system (or section) ¹	Supply fixture unit value per fixture (Subpart 2)			Total supply fixture units		
		Hot	Cold	Total	Hot	Cold	Total
Pedestal Urinal, Flush Valve	3		10	10		30	30
Flushometer Closet	6		10	10		60	60
Lavatory	6	1.5	1.5	2	9	9	12
Total					9	99	102
Supply demand in GPM					7	67	68

¹See subpart 8.

Referring to subpart 2 for these fixtures, it is found that the total demand in supply fixture units for hot was 9 s.f.u., for cold was 99 s.f.u., and for a total demand of 102 s.f.u. By using subpart 5 curve number 2 it is determined that the supply demand in GPM for hot water is 7 and by using the same figure but curve 1 it is determined that the demand for cold water in GPM is 67 and the total demand in GPM is 68. This breakdown is used in order to size the hot water supply branch, the cold water supply branch and the building service line.

Subp. 7. **Example.** Assume an apartment building (private type occupancy) having 200 bathroom groups with flushometer closets and 200 kitchen sinks. The apartment lawn has installed in it a sprinkler system operating from (7) sill cocks. What is the demand flow for which the water service to the apartment must be designed? The intermittent use fixtures are figured as in subpart 6 to have a demand of 326 GPM.

Name of fixture	Number on system	Supply fixture unit value per fixture (Subpart 2)			Total supply fixture units		
		Hot	Cold	Total	Hot	Cold	Total
Bathroom group	300	3	6	8	600	1,200	1,600
Kitchen sink	200	1.5	1.5	2	300	300	400
Total					900	1,500	2,000
Demand in GPM (Subpart 4)					208	270	326

The lawn sprinkler system outlets have a demand of 5 GPM each, part 4715.1770. The total sprinkler system demand is, therefore, 35 GPM. This is added to the total demand (326) of the intermittently used fixtures making a total water demand of 361 GPM. This

total figure would then be used to determine the size of the building service pipe. The 35 GPM demand figure would also be added to the cold water demand figure of 270 giving total cold water demand of 305 GPM and this figure would be used in sizing the cold water distribution piping.

Subp. 8. **Selection of pipe size.** Pipe sizes may be selected according to the following water pipe sizing procedure except that in no case shall a pipe size be less than shown in part 4715.1730, subpart 2, nor in the case of water service lines, less than specified in part 4715.1710.

The water pipe sizing procedure is based on a system of pressure requirements and losses, the sum of which must not exceed the minimum pressure available at the street main or other source of supply. These pressures are expressed as follows:

- A. Pressure required at fixture to produce adequate flow -- See part 4715.1770.
- B. Static Pressure loss -- This is computed at 0.43 psi per ft of pipe rise or drop and is added or subtracted respectively.
- C. Loss through water meter -- Pressure or friction losses for various size meters are shown in subpart 9 or 10.
- D. Loss through taps in water main -- Losses for various size taps are shown in subpart 12.
- E. Losses through special devices such as filters, water softeners, backflow preventers, etc. -- These must be obtained from the manufacturer, or estimated and added to the total.
- F. Loss through fittings and valves -- Losses for these devices are computed by converting the fittings or valves to equivalent straight sections of pipe and adding this length to the total for the pipe section being considered. Subpart 11 shows equivalent lengths of pipe for fittings and valves.
- G. Loss due to pipe friction -- This loss may be readily computed when the pipe size, its length and the flow through the pipe are known. When these three factors are known the friction loss can be determined from either the tables in subparts 13 and 19 or the figures in subparts 14, 16, 18, and 20. The table and the figure used depends on the type of pipe used. An example of this sizing procedure is given in subpart 21.

Subp. 9. **Loss of pressure through disk-type meters in pounds per square inch.**

Gallons per minute	Size of meter							
	5/8"	3/4"	1"	1-1/2"	2"	3"	4"	6"
4	1.0							
5	1.6							
6	2.2							
7	3.0	1.1						
8	4.0	1.4						
9	5.0	1.7						
10	6.1	2.1						
15	14	5.0	2.0					

MINNESOTA RULES 2011

921

PLUMBING CODE 4715.3700

20	8.8	3.5	1.0							
30	19	8.0	2.3							
40		14	4.0	1.6						
50		22	6.2	2.4						
60			9.0	3.6						
70			12	4.9	1.3					
80			16	6.2	1.7					
90			20	8.0	2.0					
100				10	2.5 1.0					
120				14	3.7 1.3					
140				20	5.1 2.0					
160					6.2 2.4					
180					8.1 3.3					
200					10 4.0 1.0					
250					16 6.1 1.7					
300					23 9.0 2.3					
350						13.0 3.0				
400						16.0 4.0				
500						25.0 6.1				
600							9.0			
700								13		
800									16	
900										20

MINNESOTA RULES 2011

4715.3700 PLUMBING CODE

922

Subp. 10. Graph of loss of pressure through disk-type meters in pounds per square inch.

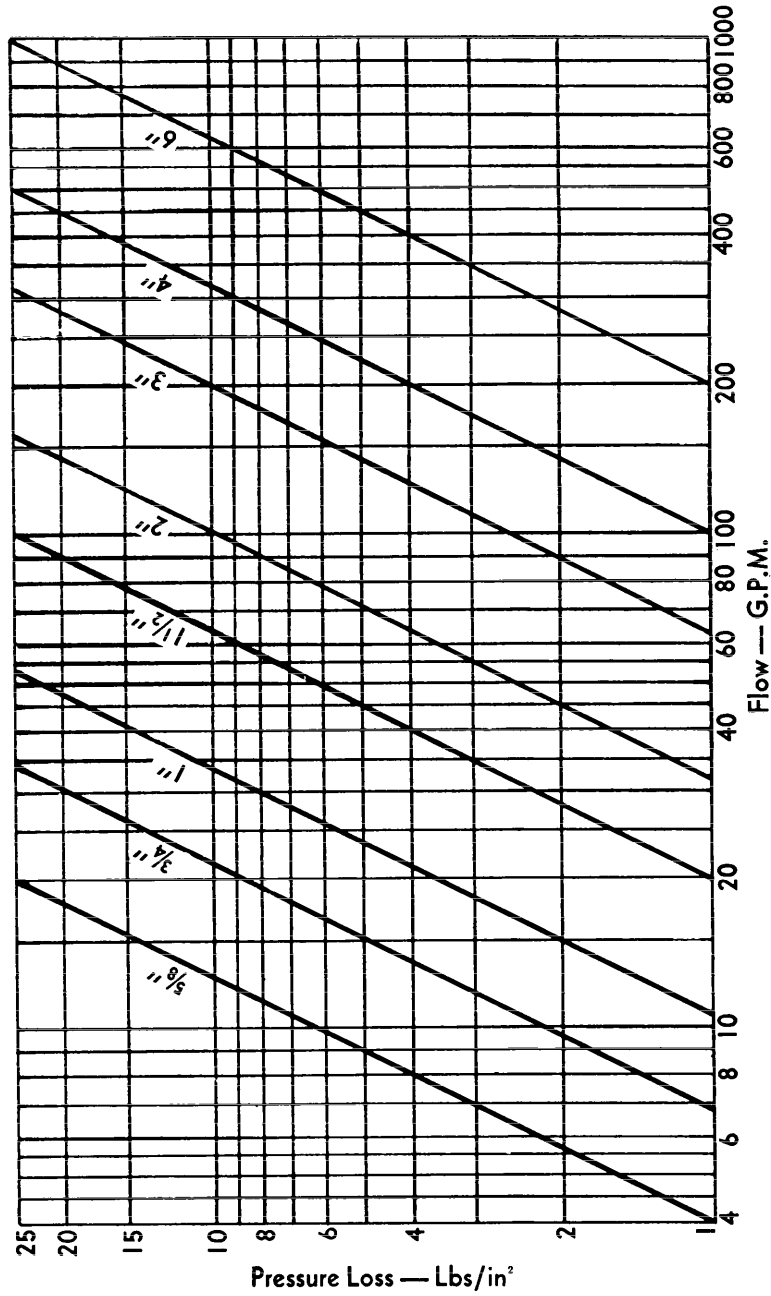

MINNESOTA RULES 2011

923

PLUMBING CODE 4715.3700

Subp. 11. Allowance in equivalent length of pipe for friction loss in valves and threaded fittings.

Diameter of fitting, inches	90° std. ell, feet	45° std. ell, feet	90° side tee, feet	Coupling or straight run of tee, feet	Gate valve, feet	Globe valve, feet	Angle valve, feet
3/8	1	0.6	1.5	0.3	0.2	8	4
1/2	2	1.2	3	0.6	0.4	15	8
3/4	2.5	1.5	4	0.8	0.5	20	12
1	3	1.8	5	0.9	0.6	25	15
1-1/4	4	2.4	6	1.2	0.8	35	18
1-1/2	5	3	7	1.5	1.0	45	22
2	7	4	10	2	1.3	55	28
2-1/2	8	5	12	2.5	1.6	65	34
3	10	6	15	3	2	80	40
3-1/2	12	7	18	3.6	2.4	100	50
4	14	8	21	4.0	2.7	125	55
5	17	10	25	5	3.3	140	70
6	20	12	30	6	4	165	80

Subp. 12. Loss of pressure through taps and tees in pounds per square inch.

Gallons per minute	Size of tap or tee						
	5/8 in.	3/4 in.	1 in.	1-1/4 in.	1 in.	2 in.	3 in.
10	1.35	0.64	0.18	0.08			
20	5.38	2.54	0.77	0.31	0.14		
30	12.1	5.72	1.62	0.69	0.33	0.10	
40		10.2	3.07	1.23	0.58	0.18	
50		15.9	4.49	1.92	0.91	0.28	
60			6.46	2.76	1.31	0.40	
70			8.79	3.76	1.78	0.55	0.10
80			11.5	4.90	2.32	0.72	0.13
90			14.5	6.21	2.94	0.91	0.16
100			17.94	7.67	3.63	1.12	0.21
120			25.8	11.0	5.23	1.61	0.30
140			35.2	15.0	7.12	2.20	0.41
150				17.2	8.16	2.52	0.47
160				19.6	9.30	2.92	0.54
180				24.8	11.8	3.62	0.68
200				30.7	14.5	4.48	0.84
225				38.8	18.4	5.67	1.06
250				47.9	22.7	7.00	1.31
275					27.4	7.70	1.59
300					32.6	10.1	1.88

MINNESOTA RULES 2011

4715.3700 PLUMBING CODE

924

Subp. 13. Pressure loss of water in pounds per square inch per 100 feet of fairly smooth pipe.

Gallons per minute	3/4"	1"	1-1/4"	1-1/2"	2"	2-1/2"	3"	4"	5"	6"	8"	10"	12"
1	0.16	-----	-----	-----	-----	-----	-----	-----	-----	-----	-----	-----	-----
2	0.57	0.17	-----	-----	-----	-----	-----	-----	-----	-----	-----	-----	-----
3	1.2	0.37	0.1	-----	-----	-----	-----	-----	-----	-----	-----	-----	-----
4	2.0	0.61	0.17	-----	-----	-----	-----	-----	-----	-----	-----	-----	-----
5	3.0	0.95	0.25	0.12	-----	-----	-----	-----	-----	-----	-----	-----	-----
10	11	3.5	0.9	0.43	0.13	-----	-----	-----	-----	-----	-----	-----	-----
15	22	7.1	1.8	0.9	0.26	0.11	-----	-----	-----	-----	-----	-----	-----
20	¹ 39	13	3.0	1.5	0.45	0.18	-----	-----	-----	-----	-----	-----	-----
25	² 58	18	4.7	2.3	0.68	0.28	0.10	-----	-----	-----	-----	-----	-----
30	-----	¹ 25	6.6	3.2	0.93	0.4	0.13	-----	-----	-----	-----	-----	-----
35	-----	¹ 35	8.5	4.3	1.2	0.53	0.18	-----	-----	-----	-----	-----	-----
40	-----	² 43	11	5.5	1.6	0.63	0.22	-----	-----	-----	-----	-----	-----
45	-----	-----	14	6.7	2.0	0.8	0.3	-----	-----	-----	-----	-----	-----
50	-----	-----	¹ 17	8.1	2.4	1.0	0.35	0.1	-----	-----	-----	-----	-----
60	-----	-----	¹ 23	12	3.3	1.3	0.5	0.13	-----	-----	-----	-----	-----
70	-----	-----	² 32	¹ 15	4.4	1.8	0.63	0.17	-----	-----	-----	-----	-----
80	-----	-----	-----	¹ 19	5.7	2.3	0.83	0.23	-----	-----	-----	-----	-----
90	-----	-----	-----	¹ 24	7.0	2.9	1.1	0.27	-----	-----	-----	-----	-----
100	-----	-----	-----	² 30	8.5	3.7	1.3	0.35	0.12	-----	-----	-----	-----
150	-----	-----	-----	-----	¹ 17	7.8	2.6	0.7	0.23	-----	-----	-----	-----
200	-----	-----	-----	-----	² 30	¹ 13	¹ 4.5	1.2	0.4	0.16	-----	-----	-----
250	-----	-----	-----	-----	-----	² 18	6.3	1.8	0.59	0.23	-----	-----	-----
300	-----	-----	-----	-----	-----	-----	¹ 9.0	2.4	0.8	0.34	-----	-----	-----
350	-----	-----	-----	-----	-----	-----	² 13	3.3	1.1	0.45	0.12	-----	-----
400	-----	-----	-----	-----	-----	-----	-----	¹ 4.2	1.3	0.59	0.15	-----	-----
450	-----	-----	-----	-----	-----	-----	-----	¹ 5.1	1.7	0.7	0.19	-----	-----
500	-----	-----	-----	-----	-----	-----	-----	¹ 6.2	2.1	0.85	0.23	-----	-----
600	-----	-----	-----	-----	-----	-----	-----	² 9.0	2.9	1.2	0.32	0.11	-----
700	-----	-----	-----	-----	-----	-----	-----	-----	¹ 3.9	1.6	0.43	0.14	-----
800	-----	-----	-----	-----	-----	-----	-----	-----	¹ 4.9	2.0	0.56	0.18	-----
900	-----	-----	-----	-----	-----	-----	-----	-----	-----	¹ 2.5	0.69	0.23	-----
1,000	-----	-----	-----	-----	-----	-----	-----	-----	-----	¹ 3.0	0.81	0.28	0.12
1,500	-----	-----	-----	-----	-----	-----	-----	-----	-----	² 6.5	¹ 1.8	0.59	0.24
2,000	-----	-----	-----	-----	-----	-----	-----	-----	-----	-----	¹ 3.0	0.98	0.4
2,500	-----	-----	-----	-----	-----	-----	-----	-----	-----	-----	² 4.5	¹ 1.5	0.61
3,000	-----	-----	-----	-----	-----	-----	-----	-----	-----	-----	-----	¹ 3.0	0.89

¹Velocity at or exceeding 10 fps.

²Velocity exceeds 15 fps.

Subp. 14. Graph of pressure loss of water in pounds per square inch per 100 feet of fairly smooth pipe.

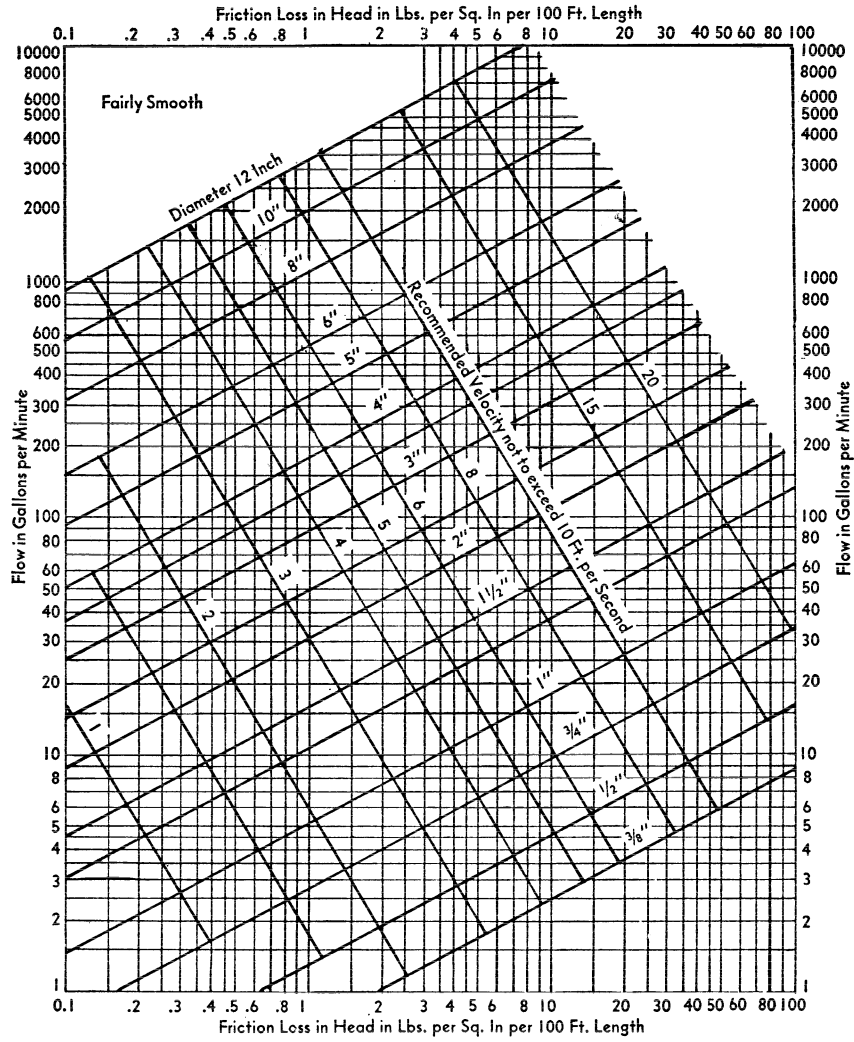

MINNESOTA RULES 2011

4715.3700 PLUMBING CODE

926

Subp. 15. Pressure loss of water in pounds per square inch per 100 feet of fairly rough pipe.

Gallons per minute	3/4"	1"	1-1/4"	1-1/2"	2"	2-1/2"	3"	4"	5"	6"	8"	10"	12"
1	0.26	-----	-----	-----	-----	-----	-----	-----	-----	-----	-----	-----	-----
2	0.91	0.22	-----	-----	-----	-----	-----	-----	-----	-----	-----	-----	-----
3	2.0	0.47	0.17	-----	-----	-----	-----	-----	-----	-----	-----	-----	-----
4	3.3	0.82	0.30	0.12	-----	-----	-----	-----	-----	-----	-----	-----	-----
5	5.2	1.3	0.45	0.18	-----	-----	-----	-----	-----	-----	-----	-----	-----
10	20	4.9	1.7	0.67	0.17	-----	-----	-----	-----	-----	-----	-----	-----
15	¹ 43	12	3.7	1.4	0.36	0.12	-----	-----	-----	-----	-----	-----	-----
20	² 80	18	6.2	2.5	0.62	0.20	-----	-----	-----	-----	-----	-----	-----
25	-----	¹ 29	9.9	3.9	0.97	0.31	0.13	-----	-----	-----	-----	-----	-----
30	-----	¹ 42	14	5.6	1.3	0.45	0.18	-----	-----	-----	-----	-----	-----
35	-----	¹ 55	18	7.3	1.8	0.60	0.25	-----	-----	-----	-----	-----	-----
40	-----	² 70	¹ 24	9.3	2.3	0.75	0.32	-----	-----	-----	-----	-----	-----
45	-----	-----	¹ 30	12	3.0	0.96	0.42	-----	-----	-----	-----	-----	-----
50	-----	-----	¹ 37	15	3.7	1.2	0.51	0.12	-----	-----	-----	-----	-----
60	-----	-----	² 52	¹ 21	5.2	1.7	0.70	0.17	-----	-----	-----	-----	-----
70	-----	-----	-----	¹ 28	7.0	2.2	0.92	0.22	-----	-----	-----	-----	-----
80	-----	-----	-----	¹ 37	9.0	2.9	1.3	0.29	0.10	-----	-----	-----	-----
90	-----	-----	-----	² 45	12	3.7	1.5	0.36	0.12	-----	-----	-----	-----
100	-----	-----	-----	-----	¹ 14	4.6	1.8	0.44	0.16	-----	-----	-----	-----
150	-----	-----	-----	-----	² 30	10	4.2	1.0	0.34	0.13	-----	-----	-----
200	-----	-----	-----	-----	-----	¹ 17	7.0	1.7	0.59	0.23	-----	-----	-----
250	-----	-----	-----	-----	-----	² 26	¹ 11	2.6	0.90	0.35	-----	-----	-----
300	-----	-----	-----	-----	-----	-----	¹ 15	3.6	1.3	0.50	0.12	-----	-----
350	-----	-----	-----	-----	-----	-----	² 21	4.9	1.7	0.69	0.17	-----	-----
400	-----	-----	-----	-----	-----	-----	-----	¹ 6.1	2.2	0.88	0.22	-----	-----
450	-----	-----	-----	-----	-----	-----	-----	¹ 7.6	2.7	1.1	0.27	-----	-----
500	-----	-----	-----	-----	-----	-----	-----	¹ 9.4	3.3	1.3	0.33	0.11	-----
600	-----	-----	-----	-----	-----	-----	-----	² 13	¹ 4.9	1.8	0.46	0.15	-----
700	-----	-----	-----	-----	-----	-----	-----	-----	¹ 6.2	2.5	0.61	0.20	-----
800	-----	-----	-----	-----	-----	-----	-----	-----	¹ 8.1	3.3	0.80	0.26	0.11
900	-----	-----	-----	-----	-----	-----	-----	-----	¹ 11	¹ 4.1	1.0	0.33	0.13
1,000	-----	-----	-----	-----	-----	-----	-----	-----	² 13	¹ 5.0	1.25	0.40	0.17
1,500	-----	-----	-----	-----	-----	-----	-----	-----	-----	² 12	2.8	0.90	0.37
2,000	-----	-----	-----	-----	-----	-----	-----	-----	-----	-----	¹ 4.7	1.6	0.63
2,500	-----	-----	-----	-----	-----	-----	-----	-----	-----	-----	² 7.2	¹ 2.4	1.0
3,000	-----	-----	-----	-----	-----	-----	-----	-----	-----	-----	-----	¹ 3.4	1.3

¹Velocity at or exceeding 10 fps.

²Velocity exceeds 15 fps.

Subp. 16. Graph of pressure loss of water in pounds per square inch per 100 feet of fairly rough pipe.

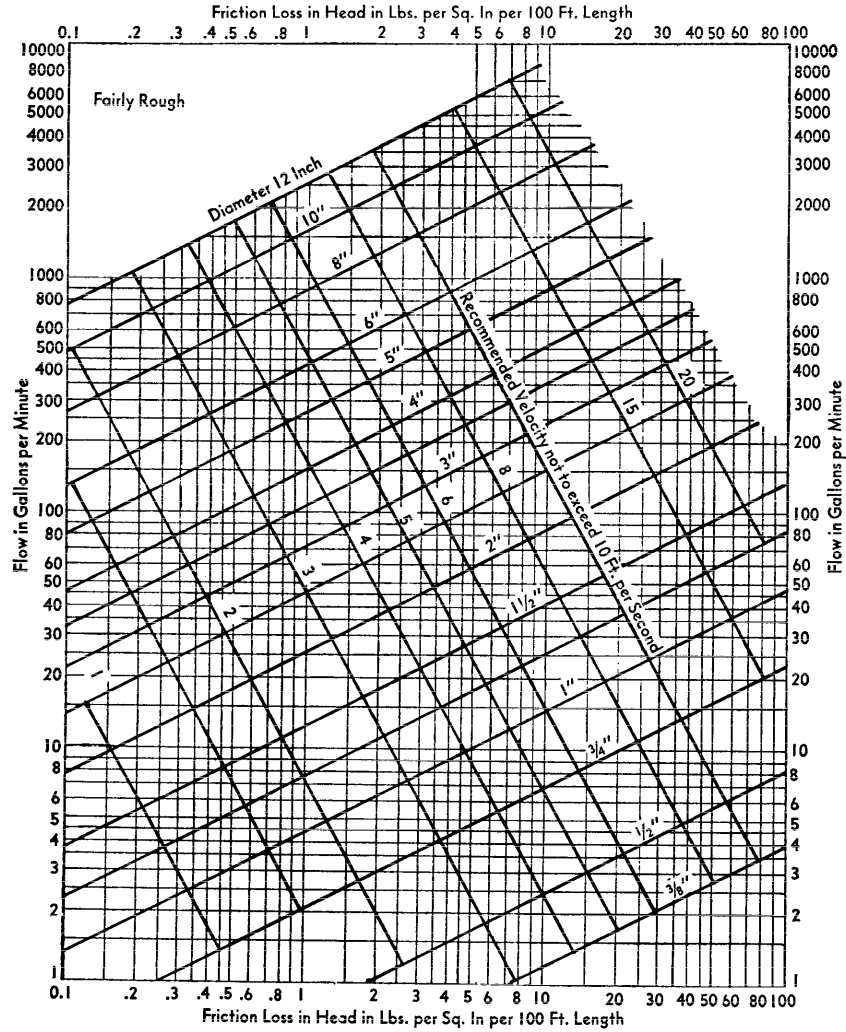

MINNESOTA RULES 2011

4715.3700 PLUMBING CODE

928

Subp. 17. Pressure loss of water in pounds per square inch per 100 feet of rough pipe.

Gallons per minute	3/4"	1"	1-1/4"	1-1/2"	2"	2-1/2"	3"	4"	5"	6"	8"	10"	12"
1	0.31	-----	-----	-----	-----	-----	-----	-----	-----	-----	-----	-----	-----
2	1.20	0.27	-----	-----	-----	-----	-----	-----	-----	-----	-----	-----	-----
3	2.7	0.62	0.20	-----	-----	-----	-----	-----	-----	-----	-----	-----	-----
4	4.7	1.2	0.36	0.15	-----	-----	-----	-----	-----	-----	-----	-----	-----
5	6.0	1.4	0.46	0.18	-----	-----	-----	-----	-----	-----	-----	-----	-----
10	30	7.0	2.3	0.94	0.22	-----	-----	-----	-----	-----	-----	-----	-----
15	¹ 67	16.0	6.2	2.1	0.49	0.17	-----	-----	-----	-----	-----	-----	-----
20	-----	27	9.1	3.7	0.89	0.29	0.12	-----	-----	-----	-----	-----	-----
25	-----	¹ 43	14	5.8	1.3	0.45	0.18	-----	-----	-----	-----	-----	-----
30	-----	¹ 62	21	8.5	2.0	0.63	0.27	-----	-----	-----	-----	-----	-----
35	-----	¹ 85	28	12	2.7	0.90	0.36	-----	-----	-----	-----	-----	-----
40	-----	-----	¹ 37	14	3.5	1.20	0.47	0.12	-----	-----	-----	-----	-----
45	-----	-----	¹ 47	19	4.5	1.45	0.60	0.14	-----	-----	-----	-----	-----
50	-----	-----	¹ 58	23	5.5	1.8	0.74	0.18	-----	-----	-----	-----	-----
60	-----	-----	² 83	¹ 33	7.9	2.6	1.10	0.25	-----	-----	-----	-----	-----
70	-----	-----	-----	¹ 46	12	3.5	1.40	0.35	0.12	-----	-----	-----	-----
80	-----	-----	-----	¹ 60	14	4.7	1.85	0.45	0.15	-----	-----	-----	-----
90	-----	-----	-----	² 76	18	5.9	2.3	0.58	0.19	-----	-----	-----	-----
100	-----	-----	-----	-----	¹ 23	7.2	3.0	0.71	0.23	-----	-----	-----	-----
150	-----	-----	-----	-----	² 50	17	6.6	1.7	0.53	0.21	-----	-----	-----
200	-----	-----	-----	-----	-----	¹ 29	12	2.9	0.95	0.37	-----	-----	-----
250	-----	-----	-----	-----	-----	² 45	¹ 18	4.5	1.49	0.58	0.13	-----	-----
300	-----	-----	-----	-----	-----	-----	¹ 26	6.4	2.20	0.80	0.19	-----	-----
350	-----	-----	-----	-----	-----	-----	² 36	8.9	2.9	1.20	0.27	-----	-----
400	-----	-----	-----	-----	-----	-----	-----	¹ 12	3.8	1.45	0.35	0.12	-----
450	-----	-----	-----	-----	-----	-----	-----	¹ 15	4.7	1.8	0.44	0.14	-----
500	-----	-----	-----	-----	-----	-----	-----	¹ 18	6.0	2.3	0.55	0.18	-----
600	-----	-----	-----	-----	-----	-----	-----	² 25	8.3	3.2	0.78	0.26	0.11
700	-----	-----	-----	-----	-----	-----	-----	-----	¹ 12	4.5	1.20	0.36	0.14
800	-----	-----	-----	-----	-----	-----	-----	-----	¹ 16	6.0	1.4	0.47	0.19
900	-----	-----	-----	-----	-----	-----	-----	-----	² 20	¹ 7.7	1.8	0.60	0.24
1,000	-----	-----	-----	-----	-----	-----	-----	-----	-----	¹ 9.4	2.3	0.75	0.31
1,500	-----	-----	-----	-----	-----	-----	-----	-----	-----	² 22	5.1	1.7	0.70
2,000	-----	-----	-----	-----	-----	-----	-----	-----	-----	-----	¹ 9.0	3.0	1.25
2,500	-----	-----	-----	-----	-----	-----	-----	-----	-----	-----	² 14	¹ 4.7	2.0
3,000	-----	-----	-----	-----	-----	-----	-----	-----	-----	-----	-----	¹ 6.8	2.7

¹Velocity at or exceeding 10 fps.

²Velocity exceeds 15 fps.

Subp. 18. Pressure loss of water in pounds per square inch per 100 feet of rough pipe.

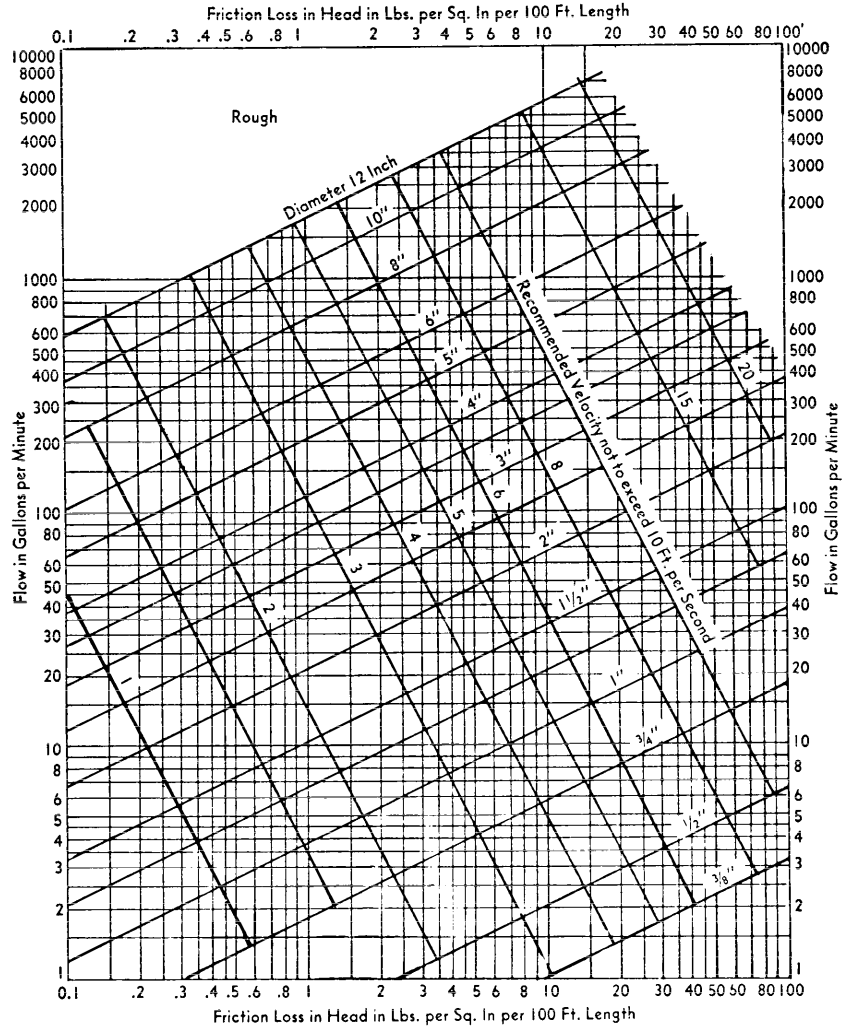

MINNESOTA RULES 2011

4715.3700 PLUMBING CODE

930

Subp. 19. Pressure loss of water in pounds per square inch per 100 feet of copper pipe.

Gallons per minute	3/4" ¹	1" ¹	1-1/4" ¹	1-1/2" ¹	2"	2-1/2"	3"	4"	5"	6"	8"	10"	12"
	0.17	-----	-----	-----	-----	-----	-----	-----	-----	-----	-----	-----	-----
	0.21	-----	-----	-----	-----	-----	-----	-----	-----	-----	-----	-----	-----
1	0.27	-----	-----	-----	-----	-----	-----	-----	-----	-----	-----	-----	-----
	0.56	0.16	-----	-----	-----	-----	-----	-----	-----	-----	-----	-----	-----
	0.66	0.18	-----	-----	-----	-----	-----	-----	-----	-----	-----	-----	-----
2	0.84	0.21	-----	-----	-----	-----	-----	-----	-----	-----	-----	-----	-----
	1.15	0.31	-----	-----	-----	-----	-----	-----	-----	-----	-----	-----	-----
	1.30	0.37	-----	-----	-----	-----	-----	-----	-----	-----	-----	-----	-----
3	1.70	0.42	0.13	-----	-----	-----	-----	-----	-----	-----	-----	-----	-----
	1.8	0.51	-----	-----	-----	-----	-----	-----	-----	-----	-----	-----	-----
	2.2	0.61	-----	-----	-----	-----	-----	-----	-----	-----	-----	-----	-----
4	2.8	0.69	0.22	0.10	-----	-----	-----	-----	-----	-----	-----	-----	-----
	2.7	0.76	-----	-----	-----	-----	-----	-----	-----	-----	-----	-----	-----
	3.3	0.90	-----	-----	-----	-----	-----	-----	-----	-----	-----	-----	-----
5	4.2	1.05	0.34	0.15	-----	-----	-----	-----	-----	-----	-----	-----	-----
	3.8	1.1	-----	-----	-----	-----	-----	-----	-----	-----	-----	-----	-----
	4.5	1.25	-----	-----	-----	-----	-----	-----	-----	-----	-----	-----	-----
6	5.7	1.4	0.47	0.21	-----	-----	-----	-----	-----	-----	-----	-----	-----
	5.0	1.4	-----	-----	-----	-----	-----	-----	-----	-----	-----	-----	-----
	6.0	1.7	-----	-----	-----	-----	-----	-----	-----	-----	-----	-----	-----
7	7.5	1.8	0.61	0.27	-----	-----	-----	-----	-----	-----	-----	-----	-----
	6.1	1.7	-----	-----	-----	-----	-----	-----	-----	-----	-----	-----	-----
	7.2	2.1	-----	-----	-----	-----	-----	-----	-----	-----	-----	-----	-----
8	9.6	2.4	0.68	0.33	-----	-----	-----	-----	-----	-----	-----	-----	-----
	7.6	2.2	-----	-----	-----	-----	-----	-----	-----	-----	-----	-----	-----
	8.9	2.5	-----	-----	-----	-----	-----	-----	-----	-----	-----	-----	-----
9	12	2.8	0.93	0.42	0.12	-----	-----	-----	-----	-----	-----	-----	-----
	9.1	2.6	-----	-----	-----	-----	-----	-----	-----	-----	-----	-----	-----
	11.5	3.0	-----	-----	-----	-----	-----	-----	-----	-----	-----	-----	-----
10	14.5	3.5	1.2	0.50	0.14	-----	-----	-----	-----	-----	-----	-----	-----
	18.5	5.2	-----	-----	-----	-----	-----	-----	-----	-----	-----	-----	-----
	² 23	6.1	-----	-----	-----	-----	-----	-----	-----	-----	-----	-----	-----
15	² 28	7.1	2.4	1.10	0.27	-----	-----	-----	-----	-----	-----	-----	-----
	² 32	8.9	-----	-----	-----	-----	-----	-----	-----	-----	-----	-----	-----
	² 37	9.9	-----	-----	-----	-----	-----	-----	-----	-----	-----	-----	-----

MINNESOTA RULES 2011

931

PLUMBING CODE 4715.3700

20	² 45	12	3.8	1.70	0.44	0.16	----	-----	----	-----	----	-----	----	-----
	³ 46	13	----	-----	----	-----	----	-----	----	-----	----	-----	----	-----
	³ 53	15	----	-----	----	-----	----	-----	----	-----	----	-----	----	-----
25	³ 67	² 17	5.8	2.5	0.68	0.23	----	-----	----	-----	----	-----	----	-----
	----	² 18	----	-----	----	-----	----	-----	----	-----	----	-----	----	-----
	----	² 21	----	-----	----	-----	----	-----	----	-----	----	-----	----	-----
30	----	² 24	8.0	3.5	0.91	0.32	0.13	-----	-----	-----	-----	-----	-----	-----
	----	² 24	----	-----	----	-----	----	-----	----	-----	----	-----	----	-----
	----	² 27	----	-----	----	-----	----	-----	----	-----	----	-----	----	-----
35	----	² 32	11	4.6	1.25	0.42	0.17	-----	-----	-----	-----	-----	-----	-----
	----	² 30	----	-----	----	-----	----	-----	----	-----	----	-----	----	-----
	----	³ 33	----	-----	----	-----	----	-----	----	-----	----	-----	----	-----
40	----	³ 38	² 13	5.8	1.50	0.52	0.22	-----	-----	-----	-----	-----	-----	-----
	----	³ 37	----	-----	----	-----	----	-----	----	-----	----	-----	----	-----
	----	³ 43	----	-----	----	-----	----	-----	----	-----	----	-----	----	-----
45	----	³ 48	² 17	7.1	1.85	0.66	0.28	-----	-----	-----	-----	-----	-----	-----
50	----	-----	² 19	8.7	2.3	0.79	0.33	-----	-----	-----	-----	-----	-----	-----
60	----	-----	³ 27	12	3.1	1.2	0.46	0.12	-----	-----	-----	-----	-----	-----
70	----	-----	----	² 16	4.2	1.4	0.62	0.16	-----	-----	-----	-----	-----	-----
80	----	-----	----	² 19	5.2	1.8	0.79	0.20	-----	-----	-----	-----	-----	-----
90	----	-----	----	³ 24	6.2	2.25	0.96	0.24	-----	-----	-----	-----	-----	-----
100	----	-----	----	-----	² 7.6	2.75	1.2	0.30	0.11	-----	-----	-----	-----	-----
150	----	-----	----	-----	³ 17	² 5.8	2.5	0.62	0.22	-----	-----	-----	-----	-----
200	----	-----	----	-----	-----	² 9.3	4.1	1.10	0.36	0.15	-----	-----	-----	-----
250	----	-----	----	-----	-----	³ 14	² 6.1	1.60	0.52	0.22	-----	-----	-----	-----
300	----	-----	----	-----	-----	-----	² 8.4	2.1	0.72	0.31	-----	-----	-----	-----
350	----	-----	----	-----	-----	-----	³ 12	2.8	0.98	0.41	-----	-----	-----	-----
400	----	-----	----	-----	-----	-----	-----	3.5	1.25	0.52	-----	-----	-----	-----
450	----	-----	----	-----	-----	-----	-----	² 4.3	1.6	0.63	-----	-----	-----	-----
500	----	-----	----	-----	-----	-----	-----	² 5.2	1.8	0.76	-----	-----	-----	-----
600	----	-----	----	-----	-----	-----	-----	³ 7.2	² 2.7	1.15	-----	-----	-----	-----
700	----	-----	----	-----	-----	-----	-----	-----	² 3.4	1.4	-----	-----	-----	-----
800	----	-----	----	-----	-----	-----	-----	-----	² 4.4	1.8	-----	-----	-----	-----
900	----	-----	----	-----	-----	-----	-----	-----	³ 5.2	² 2.2	-----	-----	-----	-----
1,000	----	-----	----	-----	-----	-----	-----	-----	-----	² 2.7	-----	-----	-----	-----

¹For the 3/4" and 1" pipe sizes the three values shown opposite each flow figure are, reading from the top, for Types M, L and K copper tubing respectively.

²Velocity at or exceeding 10 fps.

³Velocity exceeds 15 fps.

Subp. 20. Graph of pressure loss of water in pounds per square inch per 100 feet of copper pipe.

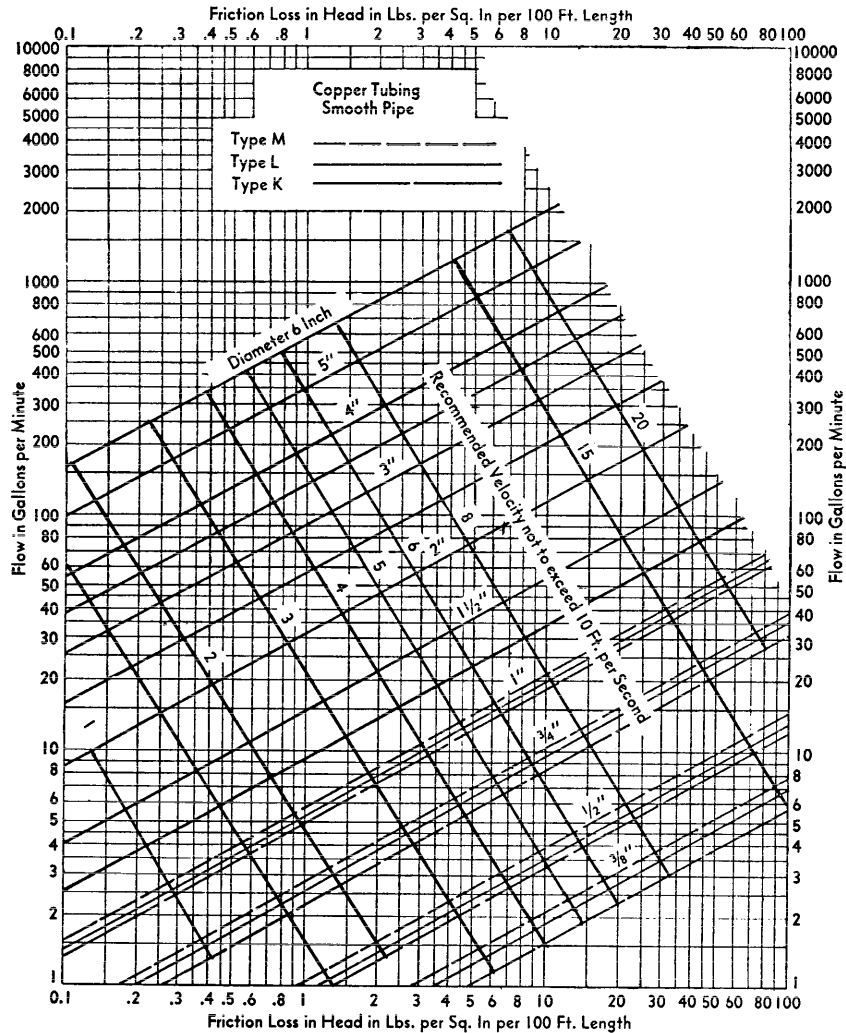

Subp. 21. **Example.** What size copper water pipe, service and distribution will be required to serve a two story factory building having on each floor, back-to-back, two toilet rooms each equipped with four flushometer closets, two flushometer pedestal urinals and four lavatories with hot and cold water? The highest fixture is 21 feet above the street main which is tapped with 2-1/2 inch corporation at which point the minimum pressure is 55 psi. In the building basement a two-inch meter and three-inch reduced pressure zone backflow preventer with a maximum pressure drop of 9 psi are to be installed. The system is shown by the following diagram. To be determined are the pipe sizes for the service main, and the cold and hot water distribution pipes. A tabular arrangement such as shown in subpart 10 should first be constructed. The steps to be followed in solving the problem are indicated by the table itself as they are in sequence, columns 1 through 8 and lines a through 1.

Subp. 22. Illustration.

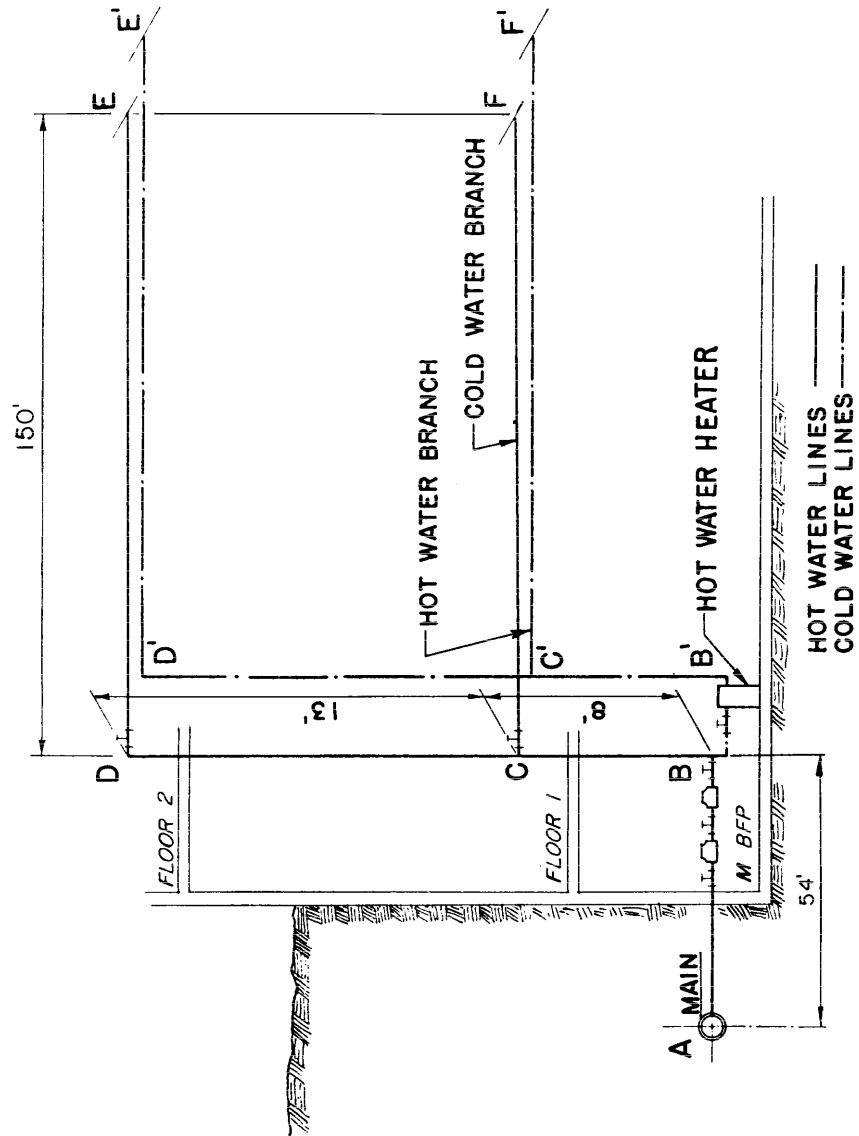

MINNESOTA RULES 2011

4715.3700 PLUMBING CODE

934

Subp. 23. Recommended tabular arrangement for use in solving pipe sizing problems.

	Line	Description	Lbs. per square inch-psi
Service and cold water distribution piping	a	Minimum pressure available at main	55.00
	b	Highest pressure required at a fixture (part 4715.1770, subpart 2)	15.00
	c	Meter loss 2" meter (subpart 9)	11.00
	d	Tap in main-loss 2-1/2" tap (subpart 12)	1.29
	e	Static head loss 21 x 0.43 psi	9.03
	f	Special fixture loss--backflow preventer	9.00
	g	Special fixture loss--filter	0.00
	h	Special fixture loss--other	0.00
	i	Total overall losses and requirements, sum of lines b through h	45.32
	j	Pressure available to overcome pipe friction, line a minus sum of lines b to h.	9.68

1	2	3	4	5	6	7	8
Pipe section	Gal. per min. through section (determined as in subpart 3)	Length of section (ft.)	Trial pipe size (in.)	Equivalent length of fittings and valves (subpart 11)	Total equivalent length of col. 3 and col. 5 (100 ft.)	Friction loss per 100' of trial size pipe (subpart 19)	Friction loss in equivalent length col. 6 x col. 7 (psi)
AB	107	54	2-1/2	12.8	0.67	3.0	2.00
BC	101	8	2-1/2	8	0.16	2.8	0.45
CF	76	150	2-1/2	1.6	1.52	1.7	2.58
CD	76	13	2-1/2	8	0.21	1.7	0.36
DE	76	150	2-1/2	1.6	1.52	1.7	2.58
	k	Total pipe friction losses (cold) 7.97 psi					7.97
	l	Difference line j minus line k					1.71

Hot Water Distribution Piping

AB'	107	54	2-1/2	12.8	0.67	3.0	2.00
B'C'	37	8	2	15.3	0.23	1.2	0.22
C'F'	28	150	2	1.3	1.51	0.8	1.21
C'D'	28	13	1-1/2	5	0.18	3.2	0.58
D'E'	28	150	1-1/2	1.0	1.51	3.2	4.84
	k	Total pipe friction losses (hot) 8.85 psi					8.85
	l	Difference line j minus line k					0.83

Subp. 24. **Directions for constructing tabular arrangement.** Step 1, column 1: divide the system into sections breaking at major changes in elevation or where branches lead to fixture groups. After point (B) (see sketch in subpart 22) separate consideration will be given to the hot and cold water piping. Enter the sections to be considered in the service and cold water piping in column 1 of the tabular arrangement.

Column 3: According to the method given in subpart 3 determine the GPM of flow to be expected in each section of the system. These flows range from 28 to 107 GPM.

Step 2, line a: enter the minimum pressure available at the main source of supply. This is 55 psi.

Line b: determine from part 4715.1770, subpart 2 the highest pressure required for the fixtures on the system, which is 15 psi to operate a flushometer valve.

Line c: select from subpart 9 the pressure loss for the meter size given or assumed. The total water flow from the main through the service as determined in step 1 will serve to aid in the meter selected.

Line d: select from subpart 12 and enter the pressure loss for the tap size given or assumed.

Line e -- Determine the difference in elevation between the main or source of supply and the highest fixture on the system and multiply this figure, expressed in feet, by 0.43 psi. Enter the resulting psi product on line e.

Line f, g, h: the pressure losses through filters, backflow preventers, or other special fixtures must be obtained from the manufacturer or estimated and entered on these lines.

Step 4, line i: the sum of (lines b through h) the pressure requirements and losses which affect the overall system is entered on this line.

Step 5, line j: subtract line i from line a. This gives the pressure which remains available for overcoming friction losses in the system. This figure is a guide to the pipe size which is chosen for each section as the total friction losses through all the sections should not exceed this value.

Step 6, column 3: enter the length of each section.

Step 7, column 4: select a trial pipe size. A rule of thumb is that size will become progressively smaller as the system extends farther from the main or source of supply.

Step 8, column 5: select from subpart 11 the equivalent lengths for the trial pipe size of fittings and valves on the section. Enter the sum for each section in column 5. (The number of fittings to be used in the installation of this piping must be an engineering estimate.)

Step 9, column 6: add the figures from column 3 and column 5, and enter in column 6. Express the sum in hundreds of feet.

Step 10, column 7: select from subpart 19 the friction loss per 100 feet of pipe for the GPM flow in a section (column 2) and the trial pipe size (column 4).

Step 11, column 8: multiply the figures in columns 6 and 7 for each section and enter in column 8.

Step 12, line k: enter the sum of the values in column 8.

Step 13, line l: subtract line k from line j. The result should always be a positive or plus figure. If it is not, it is necessary to repeat the operation utilizing columns 4, 5, 7 and 8 until a balance or near balance is obtained. If the difference between lines j and k is positive and large, it is an indication that the pipe sizes are too large and may, therefore, be reduced thus saving materials. In such a case the operations utilizing columns 4, 5, 7, and 8 should again be repeated.

Answer: the final figures entered in column 4 become the design pipe size for the respective sections. Repeating this operation a second time using the same sketch but considering the demand for hot water, it is possible to size the hot water distribution piping. This has been worked up as a part of the overall problem in the tabular arrangement used for

sizing the service and cold water distribution piping. It should be noted that consideration must be given the pressure losses from the street main to the water heater (section AB) in determining the hot water pipe sizes.

Statutory Authority: *MS s 16B.62; 326.37 to 326.45; 326B.121; 326B.43 to 326B.49*

History: *19 SR 590; L 2007 c 140 art 4 s 61; art 6 s 15; art 13 s 4*

4715.3800 RECOMMENDED GUIDE FOR SIZING WATER SUPPLY SYSTEM.

Subpart 1. **Conditions to be determined.** On any proposed water piping installation sized pursuant to subpart 9, the following conditions shall be determined:

A. Total number of fixture units as determined from the table of equivalent fixture units (subpart 8) for the fixtures to be installed.

B. Developed length of supply pipe from meter to most remote outlet, or if the pressure at the meter is unknown, use the developed length from the street main to most remote outlet.

C. Difference in elevation between the meter or other source of supply and the highest fixture or outlet.

D. Pressure in the street main or other source of supply at the locality where the installation is to be made. Calculations shall be based on not to exceed 100 psi pressure in the system.

E. In localities where there is a wide fluctuation of pressure in the main throughout the day, the water piping systems shall be designed on the basis of the minimum pressure available.

Subp. 2. **Size of street service, meter and building supply pipe using subpart 9.** Knowing the available pressure at the water meter, water main, or other source of supply, and after subtracting one-half pound per square inch pressure for each foot of difference in elevation between such source of supply and the highest water supply outlet in the building or on the premises, use the "pressure range" group within which this pressure will fall. Select the "length" column which is equal to or longer than the required length. Follow down the column to a fixture unit value equal to or greater than the total number of fixture units required by the installation. Having located the proper fixture unit value for the required length, sizes of meter and building supply pipe will be found in the two left-hand columns.

Subp. 3. **Size of branches.** The size of each branch shall be determined by the number of fixture units to be served by that branch, following the methods in subpart 2.

Subp. 4. **Sizing for flushometer valves.** Branches and mains serving water closet or similar flushometer valves may be sized from subpart 9 when the following values are assigned to each flushometer valve beginning with the most remote valve on each branch:

- A. for the first flushometer valve, 40 fixture units;
- B. for the second flushometer valve, 30 fixture units;
- C. for the third flushometer valve, 20 fixture units;
- D. for the fourth flushometer valve, 15 fixture units; and
- E. for the fifth flushometer valve, ten fixture units.

After the fifth valve on any branch, subsequent loadings may be computed using the values given in subpart 8 of this chapter. Piping supplying a flushometer valve shall not be less in size than the valve inlet.

Subp. 5. **Hot water sizing.** In sizing the hot water piping or water supply systems from subpart 9, the greatest developed length of the cold water supply piping may be used and the length of the hot water piping ignored when the hot water piping friction loss is compensated for by the following method:

A. Compute the total hot water fixture unit demand, using those values given in subpart 8 for the combined hot and cold water use.

MINNESOTA RULES 2011

937

PLUMBING CODE 4715.3800

B. Assign the total demand computed as required in item A, as the fixture unit demand at the hot water heater supply branch and inlet.

Subp. 6. **Cold water piping.** Starting at the most remote outlet on the cold water piping and working back toward the water meter, compute the pipe sizing for the system from the column originally selected in subpart 9, using the fixture unit values given in subpart 8, and adding in the fixture unit demand of the hot water heater supply inlet as computed in subpart 5, at the point where it occurs. The final size of the cold water main need not be larger than the originally established size required by subpart 9 for the total building supply.

Subp. 7. **Hot water piping.** Starting at the most remote outlets on the hot water piping and working back toward the water heater, compute the pipe sizing for the system from the column originally selected in subpart 9, using the fixture unit values given in subpart 8.

Subp. 8. **Equivalent fixture units, including combined hot and cold water demand.**

Fixture	Number of Private Use	Fixture Unit Public Use
Bar sink	1	2
Bathtub (with or without shower over)	2	4
Dental unit or cuspidor	--	1
Drinking fountain (each head)	--	1
Hose Bibb of sill cock (standard type)	3	5
House trailer (each)	6	6
Laundry tub or clothes washer (each pair of faucets)	2	4
Service sink	--	4
Lavatory	1	2
Lavatory (dental)	1	1
Lawn sprinklers (standard type, each head)	1	1
Shower (each head)	2	4
Sink (bar)	1	2
Sink or dishwasher	2	4
Sink (flushing rim, clinic)	--	10
Sink (washup, each set of faucets)	--	2
Sink (washup, circular spray)	--	4
Urinal (pedestal or similar type)	--	10
Urinal (stall)	--	5
Urinal (wall)	--	5
Urinal (flush tank)	--	3
Water closet (flush tank)	3	5
Water closet (flushometer valve)	--	10
Water supply outlets for items not listed above shall be computed at their maximum demand, but in no case less than:		
3/8 inch	1	2
1/2 inch	2	4
3/4 inch	3	6
1 inch	6	10

* See subpart 4 for method of sizing flushometer valve installations using this subpart.

MINNESOTA RULES 2011

4715.3800 PLUMBING CODE

938

Subp. 9. Fixture unit table for determining water pipe and meter sizes for water supply systems.

Pressure Range—80 to 45 psi

Meter & Street Service	Building Supply & Branches	Maximum Allowable Length in Feet									
		40	60	80	100	150	200	250	300	400	500
3/4"	1/2"	6	5	4	4	3	2	—	—	—	—
3/4"	3/4"	15	16	14	12	9	6	—	—	—	—
3/4"	1"	29	25	23	21	17	15	13	12	10	9
1"	1"	86	81	27	25	20	17	15	13	12	10
1"	1 1/4"	54	47	42	38	32	28	25	23	19	17
1 1/2"	1 1/4"	90	68	57	48	38	32	28	25	21	19
1 1/2"	1 1/2"	151	124	105	91	70	57	49	45	36	31
2"	1 1/2"	210	162	132	110	80	64	53	46	38	32
2"	2"	220	205	190	176	155	138	127	120	105	96
2"	2 1/2"	372	329	292	265	217	185	164	147	124	107
2"	2 1/2"	446	418	390	370	330	300	280	265	240	220

Pressure Range—46 to 60 psi

3/4"	1/2"	9	8	7	6	5	4	3	2	—	—
3/4"	3/4"	27	23	19	17	14	11	9	8	6	5
3/4"	1"	44	40	36	33	28	23	21	19	17	14
1"	1"	60	47	41	36	30	25	23	20	18	15
1"	1 1/4"	102	87	76	67	52	44	39	36	30	27
1 1/2"	1 1/4"	168	130	106	89	66	52	44	39	33	29
1 1/2"	1 1/2"	270	225	193	167	128	105	90	68	62	52
2"	1 1/2"	360	290	242	204	150	117	98	84	67	55
2"	2"	380	360	340	318	272	240	220	198	170	146
2"	2"	570	510	470	430	368	318	280	250	205	173
2"	2 1/2"	680	640	610	580	535	500	470	440	400	365

Pressure Range—Over 60 psi

3/4"	1/2"	11	9	8	7	6	5	4	3	2	—
3/4"	3/4"	34	28	24	22	17	13	11	10	8	—
3/4"	1"	63	53	47	42	35	30	27	24	21	18
1"	1"	87	66	55	48	38	32	29	26	22	19
1"	1 1/4"	140	126	108	96	74	62	53	47	39	34
1 1/2"	1 1/4"	237	183	150	127	93	74	62	54	43	37
1 1/2"	1 1/2"	366	311	273	240	186	154	130	113	88	73
2"	1 1/2"	490	395	333	275	220	170	142	122	98	82
2"	2"	*380	*380	*380	*380	370	335	305	282	244	212
2"	2"	*690	670	610	560	478	420	375	340	288	245
2"	2 1/2"	*690	*690	*690	*690	*690	650	610	570	510	460

*Maximum Allowable Load on Meter.

Subp. 11. [Repealed, 28 SR 146]

Subp. 11a. Example of hot water sizing using subpart 9.

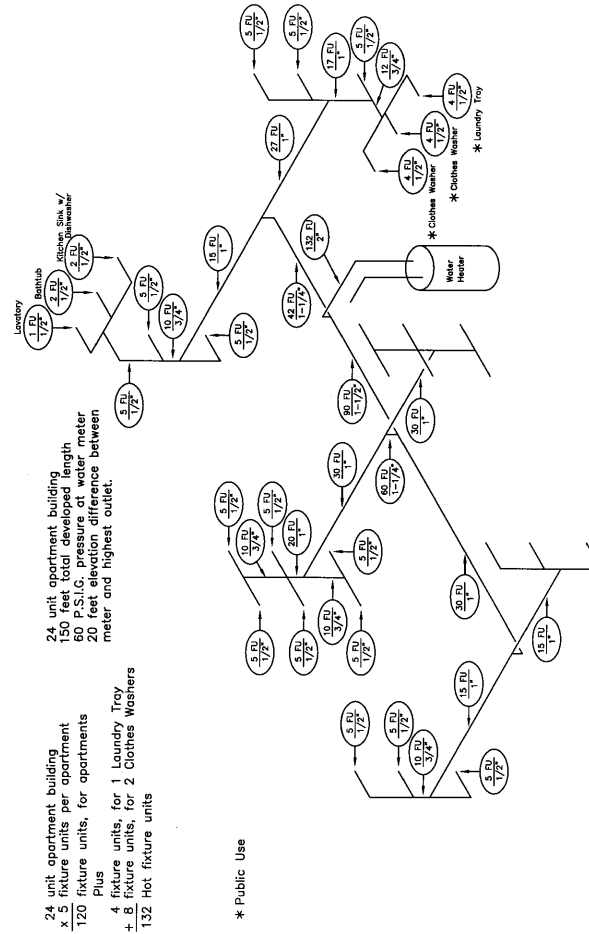

Statutory Authority: *MS s 16B.59; 16B.61; 16B.64; 326.37 to 326.45; 326B.101; 326B.106; 326B.13; 326B.43 to 326B.49*

History: *28 SR 146; L 2007 c 140 art 4 s 61; art 6 s 15; art 13 s 4*

MINNESOTA RULES 2011

941

PLUMBING CODE 4715.4100

4715.3900 [Repealed, 15 SR 76]

4715.4000 [Repealed, 15 SR 76]

4715.4100 USEFUL INFORMATION.

Subpart 1. **Weights and measures.**

Commercial Weights

16 drams or 437.5 grains = 1 ounce

16 ounces or 7000 grains = 1 pound

16 ounces = 1 pound

2000 pounds = 1 ton

Square Measure

144 square inches = 1 sq. foot

9 square feet = 1 sq. yard

30 1/4 square yards = 1 sq. rod

272 1/4 square feet = 1 sq. rod

43,560 square feet = 1 acre

Cubic Measure

231 cubic inches = 1 gallon

1728 cubic inches = 1 cu. ft.

27 cubic feet = 1 cu. yd.

Long Measure

12 inches = 1 foot

3 feet = 1 yard

16 1/2 feet = 1 rod

320 rods = 1 mile

5280 feet = 1 mile

Liquid Measure

4 gills = 1 pint

2 pints = 1 quart

4 quarts = 1 gallon

31 1/2 gallons = 1 U.S. barrel

Water Pressure

To find the pressure in pounds per square inch corresponding to any head in feet, multiply the head by 0.434.

To find the head in feet when the pressure in pounds per square inch is known, multiply the pressure by 2.3.

One pound pressure per square inch is caused by 2.3 feet head of water.

MINNESOTA RULES 2011

4715.4100 PLUMBING CODE

942

Subp. 2. **Pressure and head equivalents.** Table based on water at 62.5 pounds per cubic foot.

Head (feet)	Pressure (pounds per square inch)	Head (feet)	Pressure (pounds per square inch)
2.304	1	1	0.434
4.608	2	2	0.868
6.912	3	3	1.302
9.216	4	4	1.736
11.520	5	5	2.170
13.824	6	6	2.604
16.128	7	7	3.038
18.432	8	8	3.472
20.736	9	9	3.906
23.040	10	10	4.340

Subp. 3. **Water pressure.** Example: What pressure in pounds per square inch corresponds to a head of 123'-6"?

$$123'-6" = 123.5' \text{ (See table III)}$$

From table I (right half)

$$\begin{array}{rclcl}
 120' & = & 12 \times 10 & = & 12 \times 4.34 & = & 52.08 \\
 3' & = & 1 \times 3 & = & 1 \times 1.302 & = & 1.302 \\
 .5' & = & .5 \times 1 & = & .5 \times .434 & = & .217
 \end{array}$$

$$\underline{\hspace{2cm}} \text{ lbs/sq. in. (Ans.)}$$

Example: How many feet of head is equivalent to a pressure of 28 pounds per square inch?

From table I (left half)

$$\begin{array}{rclcl}
 20 & = & 10 \times 2 & = & 10 \times 4.608 & = & 46.08 \\
 8 & = & 1 \times 8 & = & 1 \times 18.432 & = & 18.432
 \end{array}$$

$$\underline{\hspace{2cm}} \text{ or } 64'-6" \text{ (Ans.)}$$

Subp. 4. **Effect of variations of temperatures on water.** Water freezes at 32 degrees Fahrenheit. Water boils at 212 degrees Fahrenheit. Water expands when freezing to about one and one-twelfth of its bulk. Fifteen hundred and ninety-five cubic inches of water will expand in freezing to one cubic foot of ice, which weighs approximately 57.5 pounds.

Water freezing in a pipe or closed vessel exerts a pressure of approximately 2,000 pounds per square inch which is the force that causes pipes to burst.

MINNESOTA RULES 2011

943

PLUMBING CODE 4715.4100

Subp. 5. **Changing common fractions into decimals.** In several computations used in plumbing work it is desirable to convert fractions into decimals and decimals into fractions in order to facilitate computations and measurements.

A. Example: Change 1/8 to decimals of an inch.

$$\frac{1}{8} = \frac{1.000}{8} = .125 \text{ (Ans.)}$$

B. Example: Change .3125 to closest 1/16 of an inch.

$$\frac{1}{16} = .0625$$

$$.0625 \times 5 = .3125 \text{ hence } \frac{5}{16} \text{ (Ans.)}$$

C. Example: Change 2" into decimals of a foot.

$$2" = \frac{2}{12} = \frac{2 \times 1}{12} = \frac{2 \times .08333}{1} = .16667 \text{ (Ans.)}$$

Subp. 6. Decimal equivalents of common fractions in inches.

Fraction	Decimal	Fraction	Decimal
1/32...	0.03125	17/32...	0.53125
1/16.....	.0625	9/16.....	.5625
3/32...	.09375	19/32...	.59375
1/8.....	.125	5/8.....	.625
5/32...	.15625	21/32...	.65625
3/16.....	.1875	11/16.....	.6875
7/32...	.21875	23/32...	.71875
1/4.....	.25	3/4.....	.75
9/32...	.28125	25/32...	.78125
5/16.....	.3125	13/16.....	.8125
11/32...	.34375	27/32...	.84375
3/8.....	.375	7/8.....	.875
13/32...	.40625	29/32...	.90625
7/16.....	.4375	15/16.....	.9375
15/32...	.46875	31/32...	.96875
1/2.....	.5	1.....	1.0

Subp. 7. Decimal equivalents of inches in feet.

Inches	Decimal
1	0.08333
2	0.16667
3	0.25000
4	0.33333
5	0.41667
6	0.5000
7	0.58331
8	0.66667
9	0.75
10	0.83333
11	0.91666
12	1.00

MINNESOTA RULES 2011

4715.4100 PLUMBING CODE

944

Subp. 8. Geometric calculations.

Fig. IV

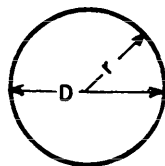

CIRCLE

D= Diameter r= Radius

C= Circumference

Area= $3.1416 \times r^2$

Area= $0.7854 \times D^2$

C= $3.1416 \times D$

D= $0.31831 \times C$

SPHERE

Area= $3.1416 \times D^2$

Volume = $0.5236 \times D^3$

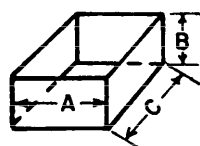

SQUARE OR OBLONG TANK

Volume= $A \times B \times C$

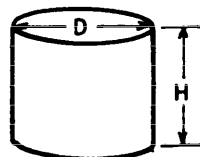

CYLINDRICAL TANK

Volume = $0.7854 \times D^2 \times H$

MINNESOTA RULES 2011

945

PLUMBING CODE 4715.4100

Subp. 9. Diameter, area, circumference, and volume.

Diameter (inches)	Area (sq. inch)	Circumference (inches)	Volume (gal. per ft.)
1/2	0.19635	1.5708	0.010
5/8	0.30680	1.9635	.016
3/4	0.44179	2.3562	.023
1	0.7854	3.1416	.041
1 1/4	1.22719	3.9270	.064
1 1/2	1.76715	4.71240	.092
2	3.1416	6.2832	.163
2 1/2	4.90875	7.8540	.255
3	7.0686	9.4248	.367
4	12.5664	12.5664	.652
5	19.6350	15.7080	1.020
6	28.2744	18.8496	1.470
8	50.2656	25.1328	2.610
10	78.5400	31.4160	4.080
12	113.0976	37.6992	5.870

A. Example: What is the area of a pipe in square inches having a diameter of six inches?
 $(A = \text{Pi}/4 \times D^2)$ $A = 0.7854 \times D^2$
 $A = 0.7854 \times 6 \times 6 = 28.27$ sq. in. (Ans.)

B. Example: What is the diameter in inches of a pipe having a circumference of approximately 15-3/4 inches?
 $(D = C \times 1/\text{Pi})$ $D = C \times 0.31831$
 $D = 15.75 \times 0.31831 = 5$ inches (Ans.)

C. Example: What is the volume of a tank in cubic feet and gallons having a length of eight feet, a width of four feet, and a depth of six feet?
 $V = 8' \times 4' \times 6' = 192$ cubic feet (Ans.)
 1 cu. ft. = 7 1/2 gallons
 $V = 192 \times 7.5 = 1440$ gallons (Ans.)

D. Example: What is the volume of a tank in cubic feet and gallons having a diameter of 18 inches and a height of 4 feet?
 $V = 0.7854 \times D^2 \times H$
 $= 0.7854 \times 1.5' \times 1.5' \times 4' = 7.0686$ cubic feet (Ans.)
 $V = 7.0686 = 53.01$ gallons (Ans.)

Doubling the diameter of a pipe increases its area four times.
 Doubling the diameter of a pipe increases its volume four times per unit of length.
 The side of a square equal in area to a given circle equals diameter x 0.8862.
 A gallon of water (U.S. standard) weighs 8-1/3 lbs.
 A cubic foot of water contains 7-1/2 gallons, 1728 cubic inches and weighs 62-1/2 pounds.

Subp. 10. Illustration of measurements.

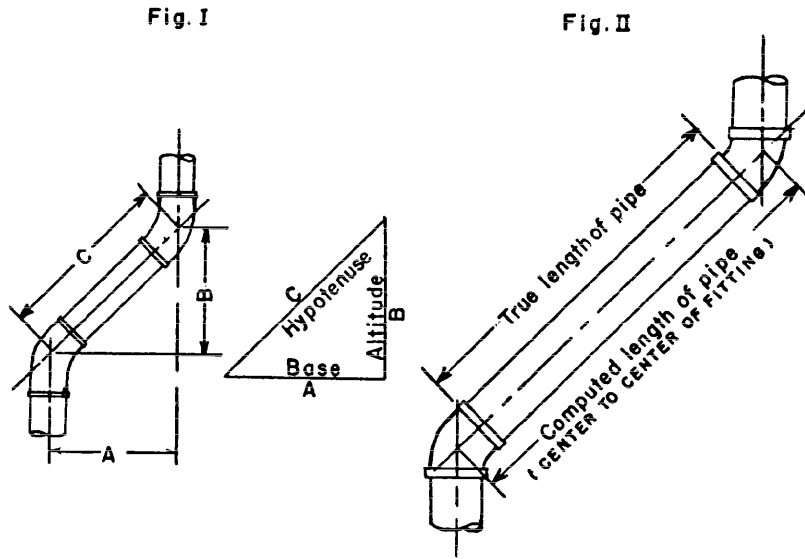

When pipes are offset, the length of the connecting pipe may be figured, when the angle of the fittings is known and one of the dimensions A, B, or C is known.

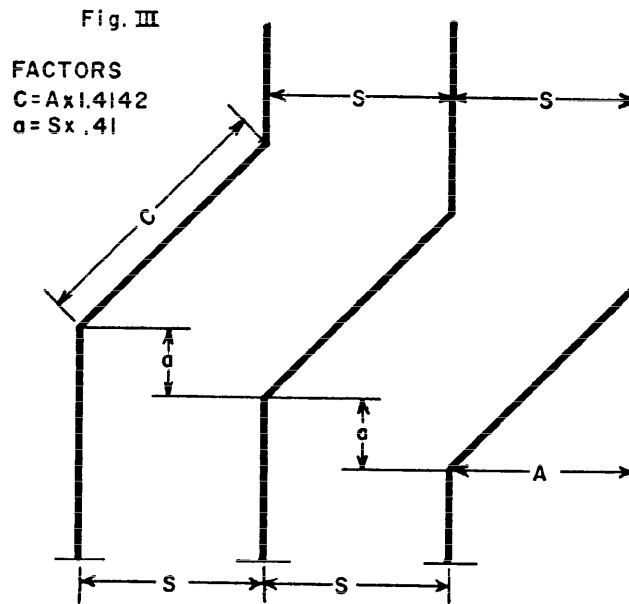

MINNESOTA RULES 2011

947

PLUMBING CODE 4715.4100

Subp. 11. Pipe fitting angle calculations.

Fittings	A	B	C	
1/64 bend	5-5/8 degrees	A = Cx.098	B = Cx.9952	C = Bx1.005
		A = Bx.0985	B = Ax10.1532	C = Ax10.204
1/32 bend	11-1/4 degrees	A = Cx.195	B = Cx.981	C = Bx1.019
		A = Bx.1989	B = Ax5.0273	C = Ax5.1258
1/16 bend	22-1/2 degrees	A = Cx.3827	B = Cx.9239	C = Bx1.0823
		A = Bx.4142	B = Ax2.4142	C = Ax2.6131
1/12 bend	30 degrees	A = Cx.5	B = Cx.866	C = Bx1.1547
		A = Bx.5774	B = Ax1.7321	C = Ax2.00
1/8 bend	45 degrees	A = Cx.7071	B = Cx.7071	C = Bx1.4142
		A = B	B = A	C = Ax1.4142
1/6 bend	60 degrees	A = Cx.866	B = Cx.5	C = Bx2.0
		A = Bx1.732	B = Ax.5774	C = Ax1.1547
3/16 bend	67-1/2 degrees	A = Cx.9239	B = Cx.3827	C = Bx2.6131
		A = Bx2.4142	B = Ax.4142	C = Ax1.0923
1/5 bend	72 degrees	A = Cx.951	B = Cx.309	C = Bx.324
		A = Bx3.0777	B = Ax.325	C = Ax1.0514

When the figures from this table are used, it will be necessary to allow for the distance taken up by the fittings. (See Fig. II, in subpart 10.)

Examples:

- A. What is the length of pipe center to center of 45 degree elbows, with an offset of 22 inches?

From table V under 45 degree fittings

$$C = Ax1.4142$$

$$C = 22x1.4142 = 31.1124 \text{ inches}$$

$$31.1124' = 2' 7\text{-}1/8" \text{ (Ans.)}$$

- B. What is the length of pipe center to center of 60 degree fittings, with an offset of 2' 8"?

From table V under 60 degree fittings

$$C = Ax1.1547$$

$$C = 32x1.1547 = 36.9504 \text{ inches}$$

$$36.9504" = 3' 15/16" \text{ (Ans.)}$$

Statutory Authority: *MS s 326.37 to 326.45; 326B.43 to 326B.49*

History: *L 2007 c 140 art 6 s 15; art 13 s 4*

WATER CONDITIONING CONTRACTORS AND INSTALLERS

4715.5000 SCOPE AND APPLICABILITY.

Parts 4715.5000 to 4715.6000 prescribe minimum standards and procedures for all water conditioning installations and servicing in single-family dwellings. Any person who installs or services water conditioning equipment, whether or not such person is licensed pursuant to Minnesota Statutes 1978, sections 328.57 to 328.66, must comply with the standards and procedures prescribed in parts 4715.5000 to 4715.6000, and with the applicable provisions of the current version of the Minnesota Plumbing Code, parts 4715.0100 to 4715.2860.

Statutory Authority: *MS s 326.60; 326B.55*

History: *L 2007 c 140 art 7 s 13; art 13 s 4*

4715.5100 DEFINITIONS.

Subpart 1. **Commissioner.** "Commissioner" means the commissioner of health.

Subp. 2. **Disinfect.** "Disinfect" means to destroy pathogenic bacteria and other harmful organisms.

Subp. 3. **Installation.** "Installation" as defined in Minnesota Statutes 1978, section 326.61, subdivision 1 includes:

- A. the connection of any water conditioning equipment to an existing water distribution system;
- B. the connection of the line carrying conditioned water to a water distribution system, or raw water to points not needing conditioned water;
- C. the connecting of drain and overflow lines which drain the equipment; and
- D. the providing of an air gap between the drain and overflow lines and the receiving building receptor.

Subp. 4. **Raw water.** "Raw water" means water which has not passed through any water conditioning equipment.

Subp. 5. **Receptor.** "Receptor" means an open, accessible, individual waste sink, floor drain, or other fixture which is trapped and vented in accordance with the Minnesota Plumbing Code (parts 4715.0100 to 4715.2860).

Subp. 6. **Servicing.** "Servicing" means repairs or adjustments to any water conditioning installations.

Subp. 7. **Water conditioning contractor.** "Water conditioning contractor" means the person in a firm or corporation who has demonstrated skill in planning, superintending, installing, and servicing water conditioning installations.

Subp. 8. **Water conditioning equipment.** "Water conditioning equipment" (equipment) means any appliance, appurtenance, or fixture designed to treat water, so as to alter, modify, add, or remove any minerals, chemicals, or bacteria contained in water.

Subp. 9. **Water conditioning installer.** "Water conditioning installer" means a person, other than a water conditioning contractor, who has demonstrated practical knowledge of water conditioning installation and servicing.

Subp. 10. **Water distribution system.** "Water distribution system" means a water supply system as defined in the Minnesota Plumbing Code (part 4715.0100).

Statutory Authority: *MS s 326.60; 326B.55*

History: *L 2007 c 140 art 7 s 13; art 13 s 4*

4715.5200 CONNECTION WITH WATER DISTRIBUTION SYSTEM.

Any water conditioning equipment may be installed only in connection with a water distribution system which has already been constructed. Such connection may be made either by cutting into a cold water line or by connecting to a joint specifically installed for

the purpose. In connecting the equipment the contractor or installer may use only the type of pipe material which is permitted in the Minnesota Plumbing Code (parts 4715.0100 to 4715.2860).

Every installation shall include the installation of a bypass valve which would allow the equipment to be serviced or removed without the need for shutting off the water service completely.

If the homeowner so requests, the installer or contractor is permitted to install a line which bypasses the water conditioning equipment and to connect this raw water line to any existing service outlet.

Statutory Authority: *MS s 326.60; 326B.55*

History: *L 2007 c 140 art 7 s 13; art 13 s 4*

4715.5300 EQUIPMENT DRAIN.

The equipment drain line shall drain into the existing receptor such as a floor drain or laundry tub. No drain or overflow line leading from the equipment shall be directly connected to any receptor. Between the delivery end of the drain or overflow line and the receptor, there must be an air gap which is at least two times the diameter of the drain or overflow line, but in no case shall the air gap be less than 1.5 inches. This air gap distance shall apply above the flood level rim of the receiving fixture to provide the required air gap. If flexible drain line is used, it must be secured in some manner to prevent its being accidentally moved.

Statutory Authority: *MS s 326.60; 326B.55*

History: *L 2007 c 140 art 7 s 13; art 13 s 4*

4715.5400 LOCATION.

Any water conditioning equipment and the piping necessary to install such equipment shall not be placed in such a location or manner so as to interfere with the normal operation of existing windows, doors, or other exits or openings, nor shall it be located in such a place so as to make other existing equipment inaccessible.

Statutory Authority: *MS s 326.60; 326B.55*

History: *L 2007 c 140 art 7 s 13; art 13 s 4*

4715.5500 REGENERATION SANITATION PROCEDURES.

All new or used water conditioning equipment shall be disinfected before being installed. All portable exchange water conditioning equipment shall be disinfected during every regeneration. Disinfection shall be achieved by the application of chlorine or a chlorine compound such as sodium or calcium hypochlorite, during the fresh water rinse, to provide an effluent minimum chlorine residual and time combination as given in the following table:

Minimum Time Minutes	Minimum Chlorine Residual -- parts per million
4	20
5	15
10	7.5
15	5.0
20	4.0

Statutory Authority: *MS s 326.60; 326B.55*

History: *L 2007 c 140 art 7 s 13; art 13 s 4*

4715.5600 PLUMBING CODE

950

4715.5600 [Repealed, L 2007 c 140 art 13 s 3]**4715.5700 EQUIPMENT AND MATERIALS USED IN INSTALLATIONS.**

Where applicable, the following shall conform to the Minnesota Plumbing Code (parts 4715.0100 to 4715.2860): all materials and connections used in the installation of water conditioning and treatment equipment; all attachments to the building.

In accordance with the Minnesota Plumbing Code (parts 4715.0100 to 4715.2860):

A. the bypass valve assembly shall be the same size as the line in which it is installed and shall be a full-way valve unless a bypass valve which complies with part 4715.5200 is supplied as an integral part of the water conditioning equipment;

B. joints and connections which are made in the course of installing water conditioning and treatment equipment shall be tested for water tightness;

C. copper tube joints shall be soldered or brazed;

D. soft copper tubing joints may be flared or soldered;

E. vertical piping shall be secured at sufficiently close intervals to keep the pipe in alignment and carry the weight of the pipe; and

F. horizontal piping shall be supported at sufficiently close intervals to keep it in alignment and prevent sagging.

Statutory Authority: *MS s 326.60; 326B.55*

History: *L 2007 c 140 art 7 s 13; art 13 s 4*

4715.5800 LICENSING.

Subpart 1. **Examination.** A written examination for the licensing of water conditioning equipment contractors and installers shall be given at least once per year. The licensing examination for contractors and installers shall include questions covering one or more of the following subject areas: relevant plumbing and installation provisions, materials and tools of the trade, general principles of water conditioning processes, and operation of water conditioning equipment. In addition to the above, the contractor's licensing examination shall include questions covering one or more of the following subjects: calculations to determine appropriate equipment size, and specific functions and processes involved in different types of water conditioning.

Subp. 2. **Examination requirements for installers.** The examination for the installer's license shall be given only to persons who have had at least six months' experience in the field of water conditioning installation and servicing.

Subp. 3. **Contractor's license requirement.** The examination for the contractor's license shall be given only to persons who have had at least 12 months' experience in planning and supervising the installation and servicing of water conditioning equipment.

Subp. 4. **Application.** A person applying to take an examination shall complete an application supplied by the Minnesota Department of Health and return the completed application along with the appropriate examination fee.

Subp. 5. **Results of the examination and license.** A grade of 70 percent shall be considered a passing grade. The applicant shall be notified of the results of the examination. A license shall be issued to an applicant who has passed the examination upon receipt of the appropriate license fee.

Statutory Authority: *MS s 326.60; 326B.55*

History: *L 2007 c 140 art 7 s 13; art 13 s 4*

4715.5900 [Repealed, L 2007 c 140 art 13 s 3]**4715.6000 RENEWAL.**

A license expires on December 31 of the year for which it was issued. An application for renewal of a license must be received by the Minnesota Department of Health no later

MINNESOTA RULES 2011

951

PLUMBING CODE 4715.6000

than December 31. Any person who submits an application for license renewal after December 31 must pay a penalty of \$25 in addition to the annual license fee. A person who does not renew a license issued pursuant to parts 4715.5000 to 4715.6000, within two years of the date on which the former license expired, is no longer entitled to a renewal license. The person must apply for reexamination and a new license.

Statutory Authority: *MS s 16A.128; 16A.1285; 144.12; 326.37 to 326.45; 326.57 to 326.65; 326B.43 to 326B.49; 326B.52 to 326B.59*

History: *18 SR 1519; L 2007 c 140 art 6 s 15; art 7 s 13; art 13 s 4*